

TEM

On | Off and everything in between

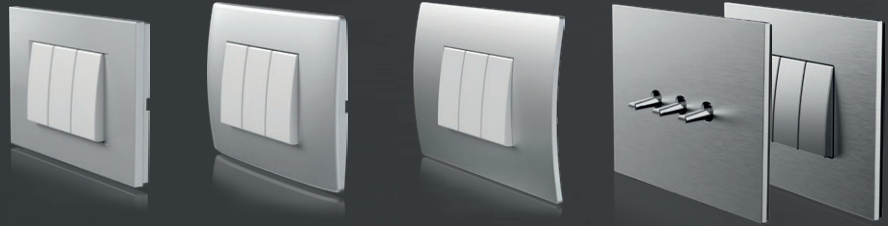

MODUL



MODUL
LINE

MODUL
SOFT

MODUL
PURE

MODUL
EDGE

44

LOGIQ



LOGIQ
FLAT

LOGIQ
BOLD

LOGIQ
PRIME

172

ekonomik



222

fontana



260



TEM

On | Off and everything in between



Ние сме производител на ключове и контакти, който осигурява на клиентите си положителен и лесен опит. Същевременно, с лесното вграждане и използване на изделията, с широката цветова гама и материали опитът ни удовлетворява и най-високите желания на всеки потребител и пространство.

We are a manufacturer of switches and sockets offering a positive and easy user experience while satisfying the most demanding needs of every user and space with products that are easy to install and use, as well as a wide range of colours and materials.

TEM

Добре дошли в семейството MODUL
Welcome to the MODUL family

Добавете лична нотка към атмосферата си и покажете
стила си с ключове и контакти от семейството MODUL.

*Give your ambience a personal touch and show off your style with
switches and sockets from MODUL family.*

откриване на нови прозрения
discovering new insights



MODUL
LINE



MODUL
SOFT



MODUL
PURE



MODUL
EDGE

1

2

MODUL
LINE



MODUL
SOFT



MODUL
PURE

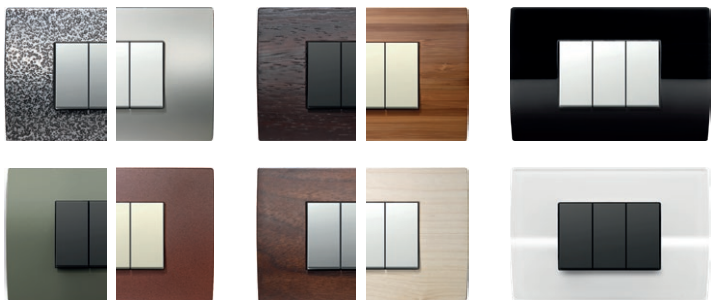

метал

дърво

СТЪКЛО

MODUL
EDGE

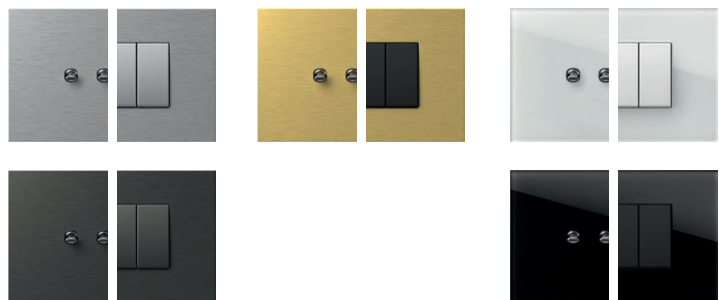

метал

метал

СТЪКЛО

3

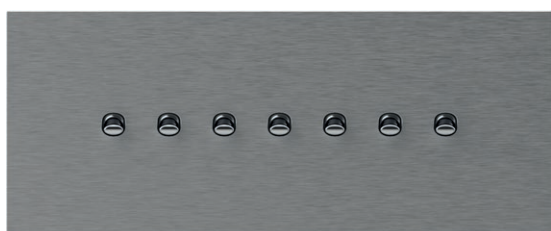
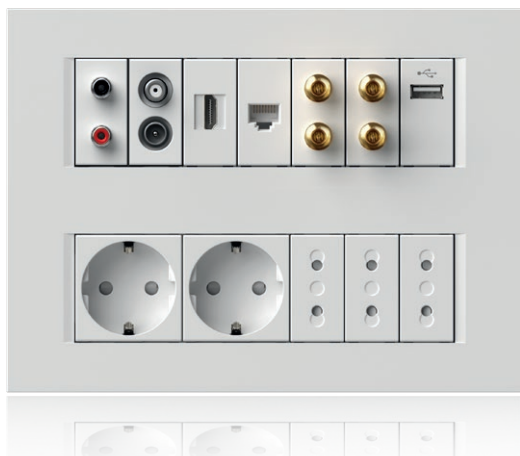

4

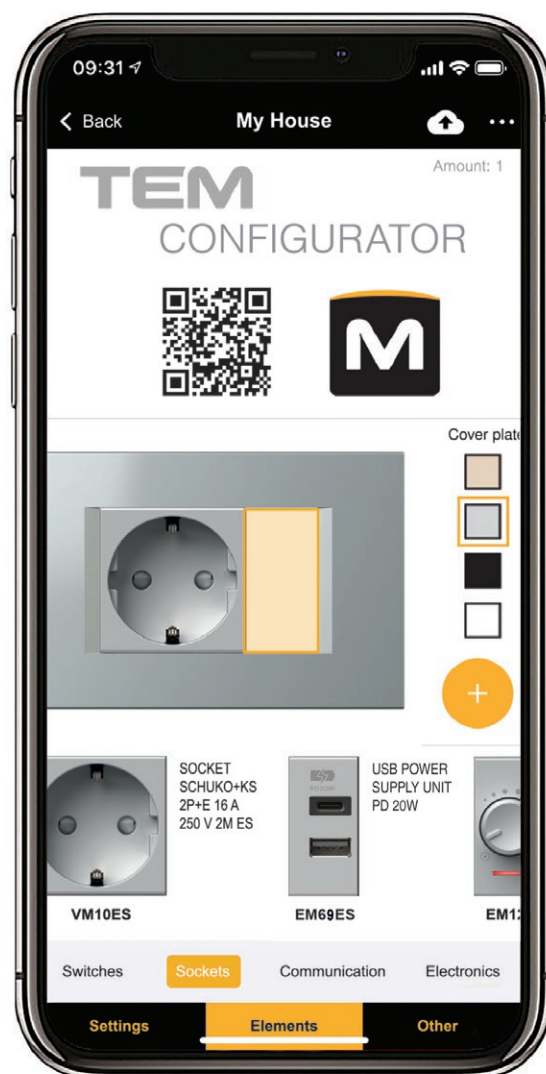

MODUL

LINE

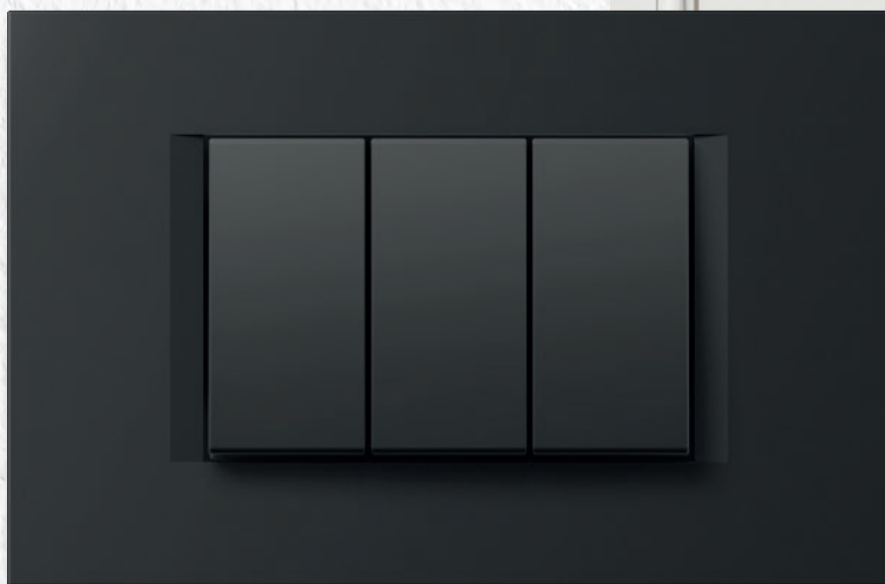

Правите, плавни линии създават дизайн, неподвластен на времето.

Straight, smooth lines create a timeless design.







MODUL

LINE

PW

MW

IW

ES

AT

SB

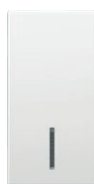
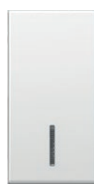

полярно бяло Бял матов цвят слонова кост елоксирано сребро антрацит меко черно

polar white matte white ivory white elox silver anthracite soft touch black

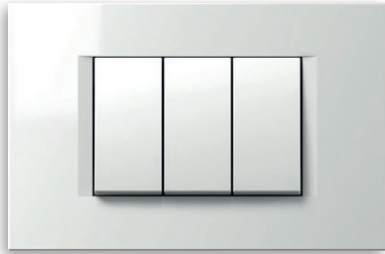

PW полярно бяло
polar white

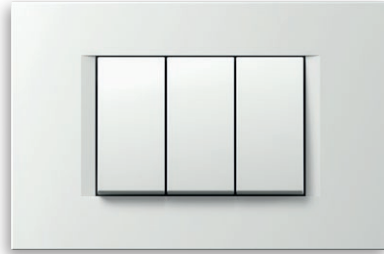

MW Бял матов цвят
matte white

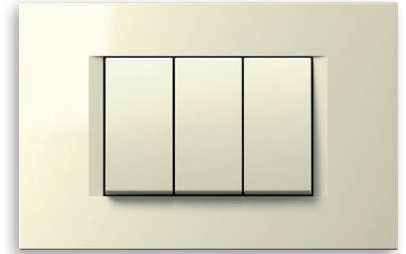

IW слонова кост
ivory white



SW каменно бяло
stone white



ES елоксирано сребро
elox silver

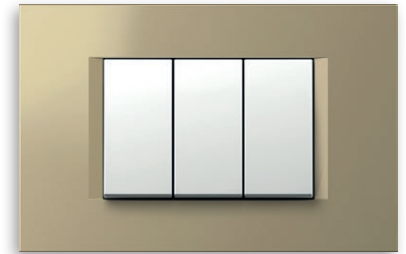

SG пясъчно злато
sand gold



TI титан
titanium

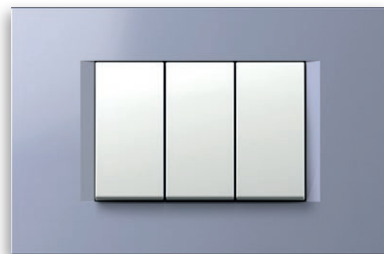

IB импулсивно синьо
impulse blue



AT антрацит
anthracite

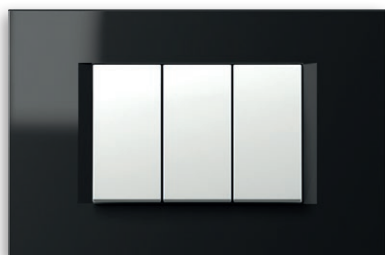

NB нощно черно
night black

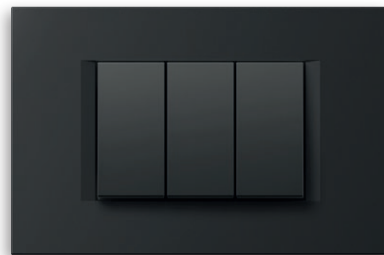

SB меко черно
soft touch black

MODUL

SOFT



Заоблените форми и леките преходи внасят мекота във
вашия дом.

*Rounded shapes and soft transitions bring softness into
your home.*





MODUL

SOFT

PW



полярно бяло

polar white

MW

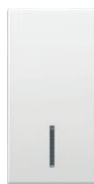

Бял матов цвят

matte white

IW



слонова кост

ivory white

ES



елоксирано
сребро

elox silver

AT

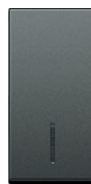

антрацит

anthracite

SB



меко черно

*soft touch
black*

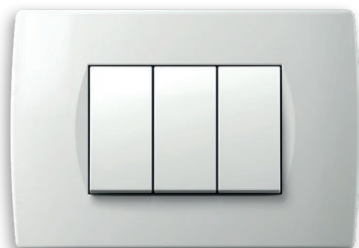

PW полярно бяло
polar white

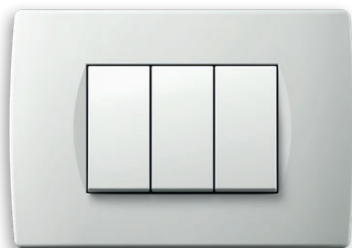

MW Бял матов цвят
matte white

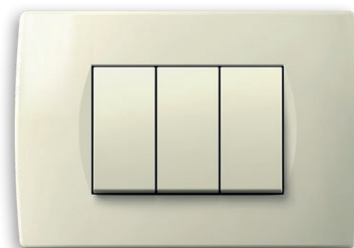

IW слонова кост
ivory white



ES елоксирано сребро
elox silver

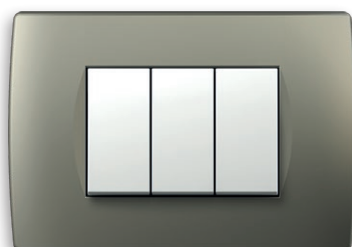

TI титан
titanium



SG пясъчно злато
sand gold

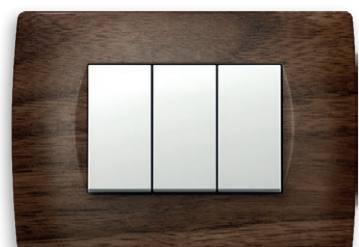

WW орех
walnut



WE венге
wenge



AT антрацит
anthracite



NB нощно черно
night black

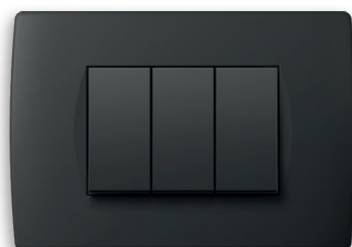

SB меко черно
soft touch black

MODUL

PURE



Детайлите представляват завършеността на цялата атмосфера. Оставете природата да обогати пространството ви с декоративни панели, изработени от дърво, стъкло и метал.

The details represent the completeness of the entire ambience. Let the nature enrich your space with decorative cover plates made of wood, glass and metal.





MODUL

PURE

PW



полярно бяло

polar white

MW

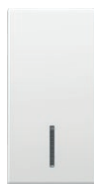

Бял матов цвят

matte white

IW



слонова кост

ivory white

ES



елоксирано
сребро

elox silver

AT

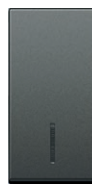

антрацит

anthracite

SB

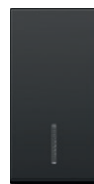

меко черно

*soft touch
black*

СТЪКЛО
glass



GL бяло
glass light

МЕТАЛ
metal



MH кована стомана
hammered steel

ДЪРВО
wood



WM клен
maple

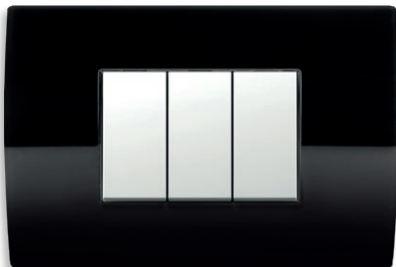

GD черно
glass dark

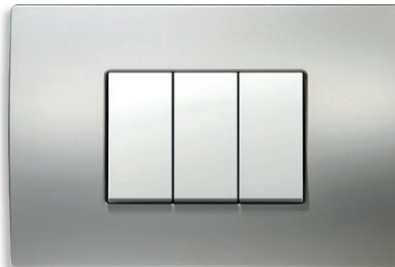

MS сатенирано сребро
satın silver



WB бамбук
bamboo



MN сатениран никел
satın nickel



WW орех
walnut



ME гравирано желязо
etched iron



WE венге
wenge

MODUL

EDGE

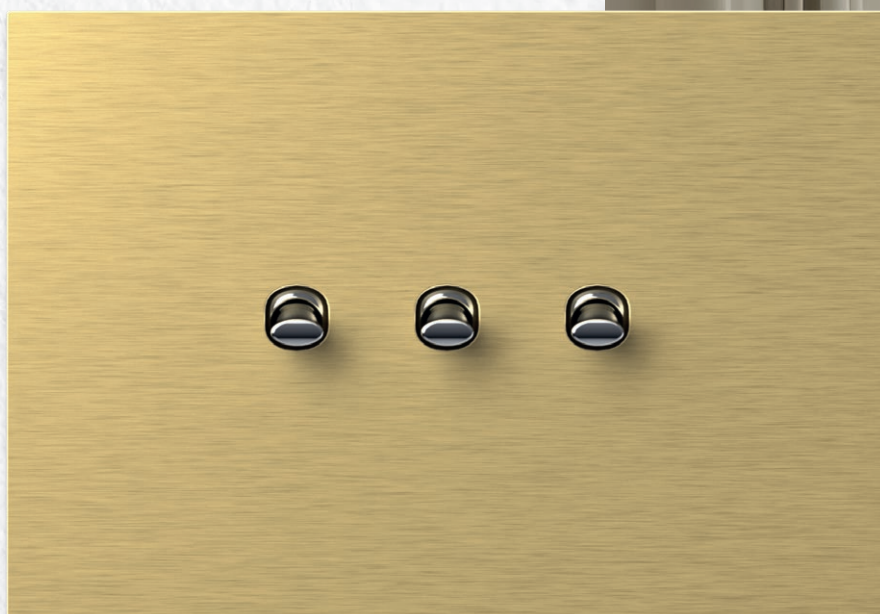

Нова престижна линия, осигуряваща
специален сетивен и визуален опит, както
никога досега.

*The new prestigious product line offers a special sensory and visual
experience like no other before. Are you bold enough?*







PB



черно

black

PA



антрацит

anthracite

PG



злато

gold

PC



хром

chrome

метал
metal

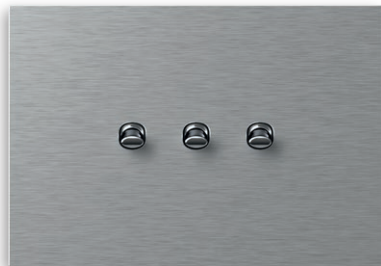

MA сребро
silver

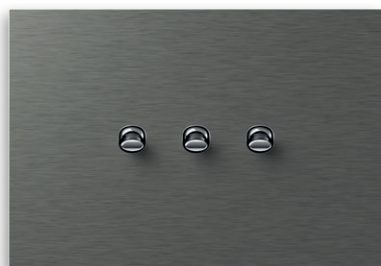
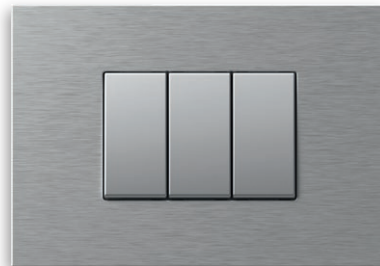

MT антрацит
anthracite

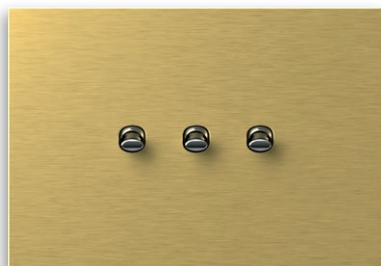
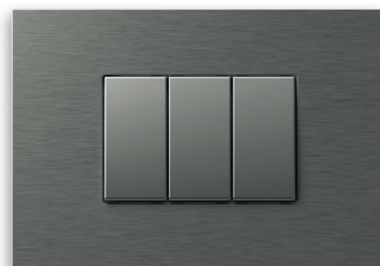

MZ злато
gold

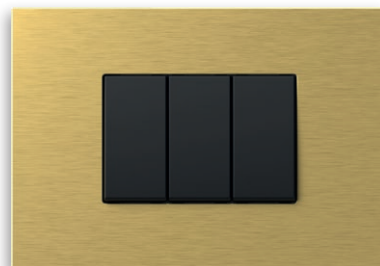

СТЪКЛО
glass

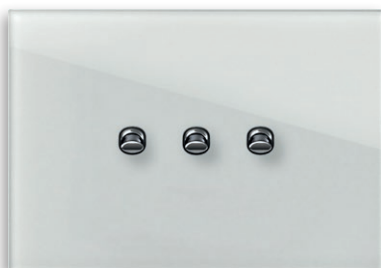

GL бяло
glass light

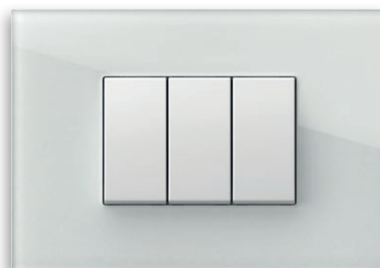

GD черно
glass dark



MODUL

EDGE



Чистотата на стъклото позволява на светлината да си играе и да се проявява в новите стъклени декоративни рамки EDGE. Контрастните цветове удовлетворяват и най-изтъчения вкус.

The purity of the glass allows the light to playfully manifest in the new EDGE glass decorative cover plates. The two contrast colours satisfy even the most sophisticated taste.





СТЪКЛО
glass



GL бяло
glass light



GD черно
glass dark

MODUL
EDGE



Благодарение на впечатляващата обработка, алуминият грейва в нова светлина – на металните декоративни рамки EDGE. В три цветови гами, заслужаващи внимание.

Thanks to the impressive treatment, the aluminium shines with a new light – EDGE metal decorative cover plates. The three colours are worthy of your attention.





метал
metal



MA сребро
silver

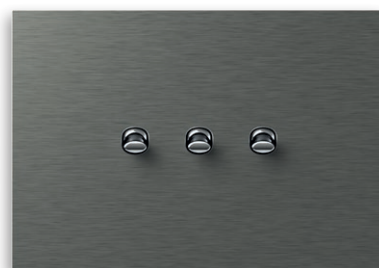

MT антрацит
anthracite

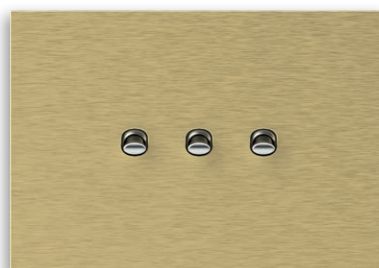

MZ золото
gold

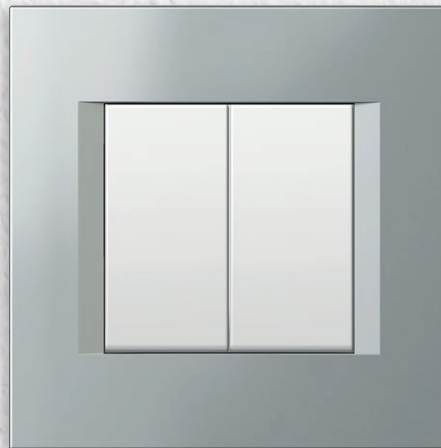

MODUL

- LINE
- SOFT
- PURE
- EDGE

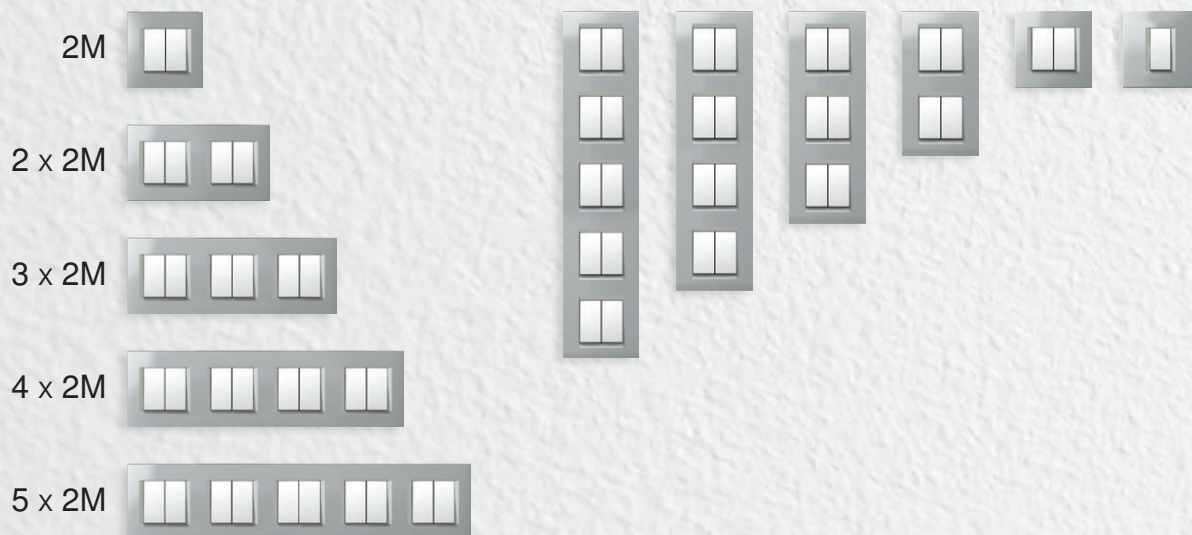
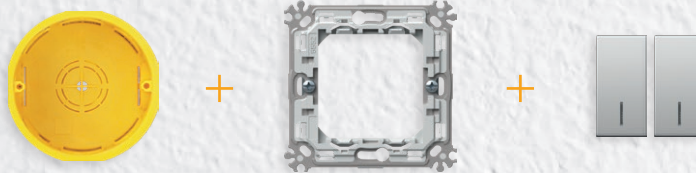

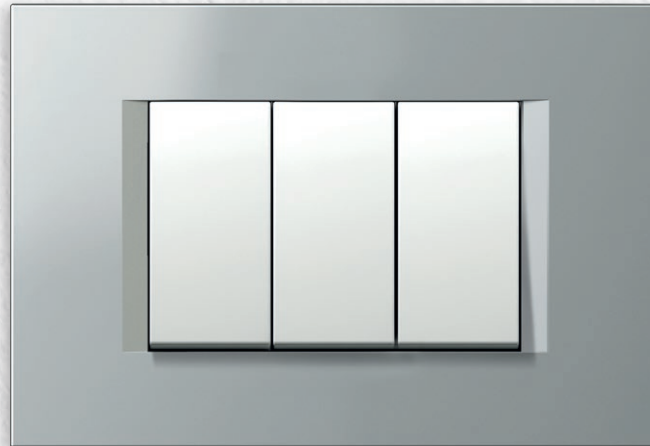

MODUL

- LINE
- SOFT
- PURE
- EDGE



2 x 7M

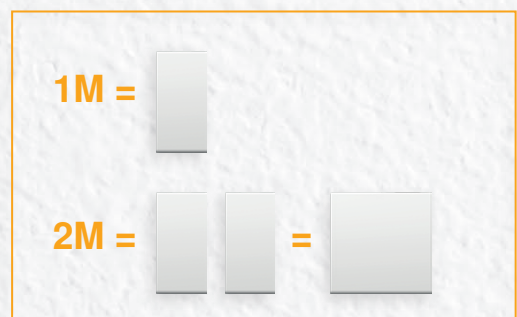

Функционалните елементи се монтират лесно в монтажната рамка.

Решението „щракване за поставяне, щракване за изваждане“, което сме разработили за вас, намалява времето за монтиране. Достъпът до контактите за съединяване е лесен откъм предната страна.

The function elements are easily fitted inside the mounting frame.

The “klik-in, klik-out” solution we have developed for you will reduce installation time. The connection contacts are easily accessible from the front.

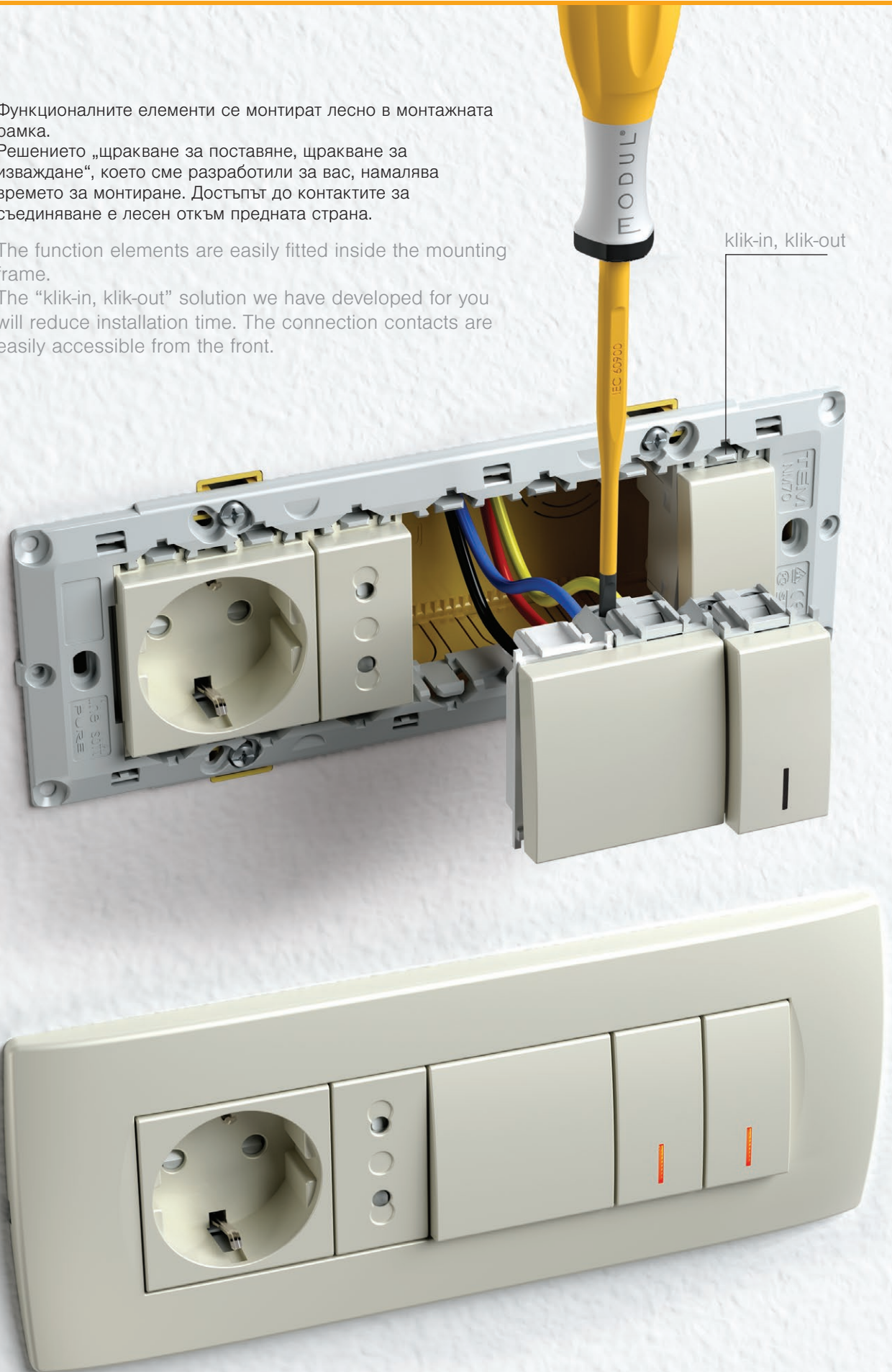

Modul е подходящ за всички видове стени и може да се използва в обикновени конструкции, както и за кухи стени или бетон. Инсталирането е лесно и ви дава възможност лесно да инсталирате и комбинирате правилните разстояния за правоъгълни и кръгли конзоли. Използваните материали отговарят на високи стандарти.

The Modul is suitable for all wall types and can be used in conventional, hollow wall or concrete constructions. It is easy to install and enables you to combine rectangular or round boxes at the proper distances. The materials used are compliant with high standards.



тухла / brick



куха стена / hollow wall



бетон / concrete

Modul предоставя голям брой възможности даже с кръгли конзоли. Можете да ги комбинирате хоризонтално или вертикално, самостоятелно или във вид на групи. Металната монтажна рамка гарантира отлична стабилност дори при работа с кръгли елементи и е подходяща за всякакви декоративни панели.

The Modul enables a many possibilities even with round boxes. You can combine them horizontally or vertically, individually or in groups. The metal mounting frame ensures excellent stability even with rough use and is suitable for any decorative cover plates.

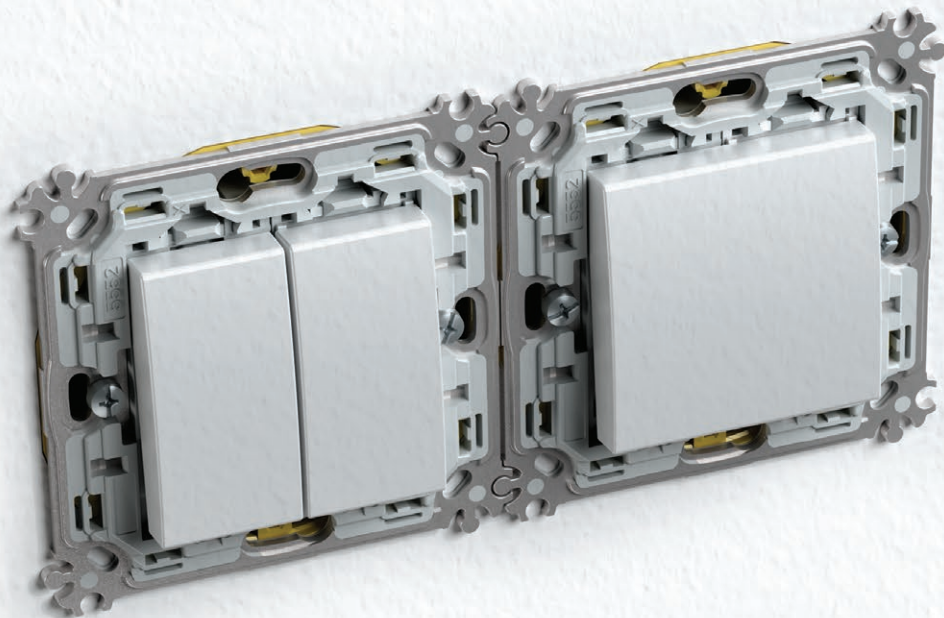



□ PW
полярно бяло
polar white



□ MW
Бял матов цвят
matte white



■ SB
меко черно
soft touch black



■ AT
антрацит
anthracite



□ ES
елоксирано сребро
elox silver



□ IW
слонова кост
ivory white

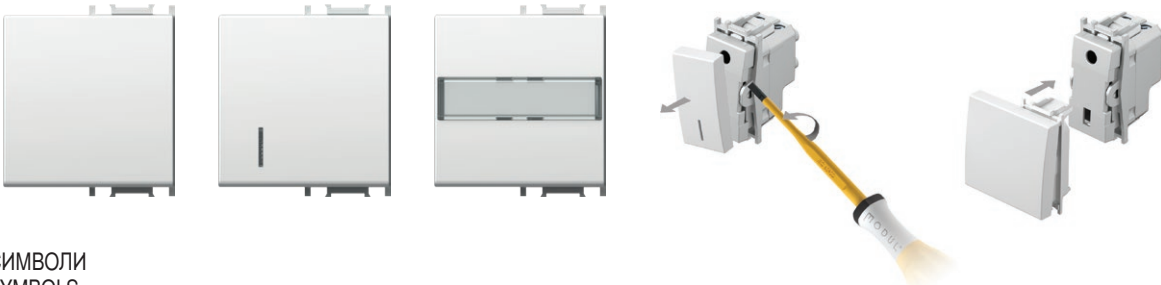

СИМВОЛИ
SYMBOLS

01	02	03	04	05	06	07	08	09	10	11	12	13	14	20	21
													1 0 2	+	-
22	23	24	25	26	27	28	29	30	31	32	33	34	35	36	37
					alarm	alarm	OFF	ON	+				AC		
38	39	40	41	42	43	44	45	46	47	48					

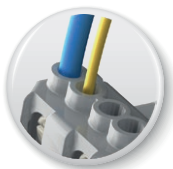
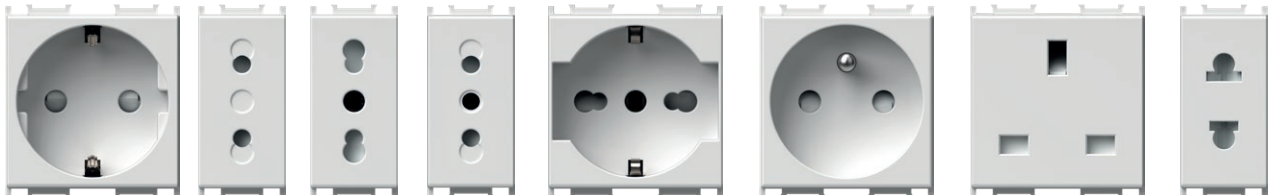

Надеждно свързване, дори при използване на проводници с различно сечение.

Reliable connection even when different size of wires are used.



Всички контакти са оборудвани за безопасно изключване, което гарантира защитата на контактите, които са под напрежение.

All the sockets are equipped with a safety shutters assuring the protection to live contacts.

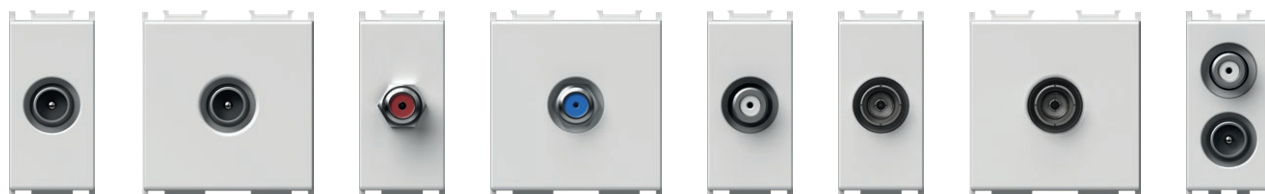
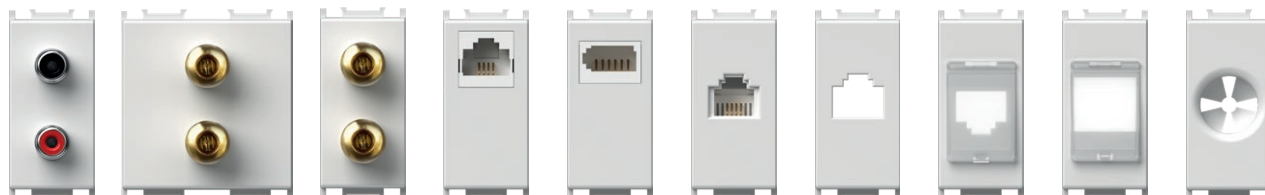

Дълъг експлоатационен живот на ключовете и съответствие с изискванията на международните стандарти.

Long-life of switches and adequacy to the international standards.



Ключът е с висока надеждност, благодарение на своите контакти със сребърни нитове.

The switch is highly reliable via its silver rivets contacts.

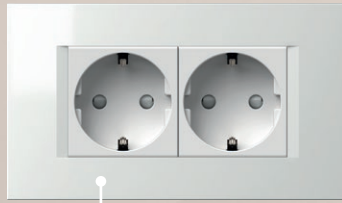
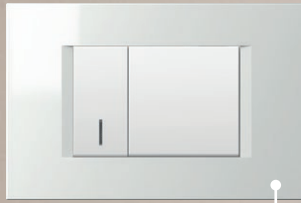



BIOPASS – ключ с четец за пръстов отпечатък
BIOPASS - fingerprint switch

Отключване без ключ.
Keyless unlocking.

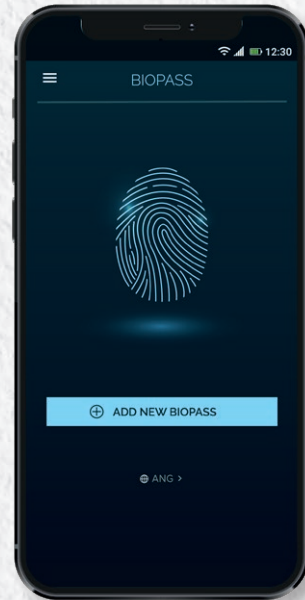

МУЛТИМЕДИЯ

MULTIMEDIA

Мултимедиен център, който ви дава възможност да свързвате няколко компонента на едно място.
Multimedia center that allows you to connect a multiple number of components in one place.



НАПРАВЕТЕ ГО УНИКАЛНО

MAKE IT UNIQUE

Изберете цвета на осветлението и добавете желаната графика, която ще подхожда на атмосферата на вашата стая.

Choose a illumination colour and add desired graphic to suit the ambience of your room.

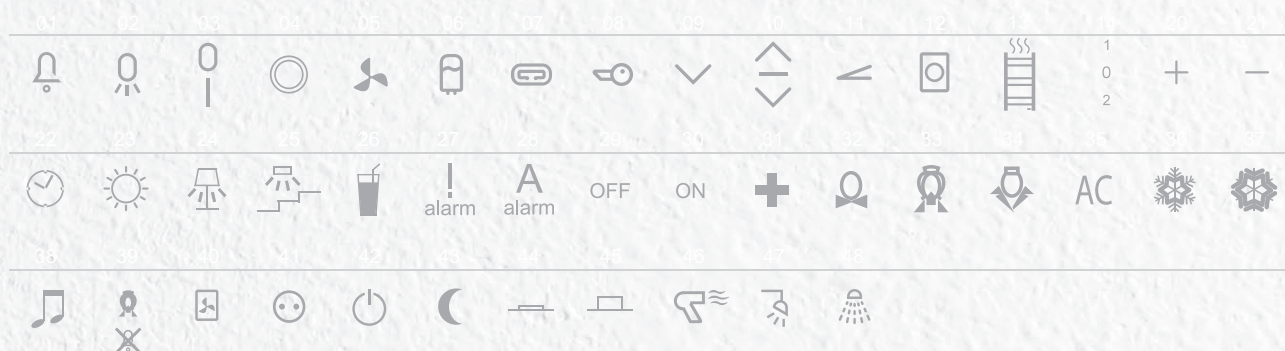

СЪЗДАЙТЕ СВОЙ СОБСТВЕН CREATE YOUR OWN

Когато поръчвате големи количества, декоративните панели и функционалните елементи могат да бъдат изработени в избрания от вас цвят.

When ordering large quantities, cover plates and function elements can be made in the colour of your choice.





МУЛТИФУНКЦИОНАЛЕН ВРЕМЕВИ КЛЮЧ

MULTIPURPOSE TIMER SWITCH

4 в 1

- таймер
- реле
- БУТОН
- Ключ

4 in 1

- timer
- relay
- push button
- switch





15'
ON/OFF



SM11

PW

IN

01

тип type	описание description	технически данни technical data	размер size	цвет colour	допълнителна информация 1 optional data 1	допълнителна информация 2 optional data 2
SM10	КЛЮЧ 1WAY SWITCH 1WAY	16AX 250V~	1M	□ PW снежнобял цвет polar white	NT неутрален neutral	🔔 01
SM11	БУТОН 1WAY PUSH BUTTON 1WAY	16A 250V~	1M	□ MW Бял матов цвет matte white	IN индикатор indicator	🔦 02
SM12	КЛЮЧ 1WAY SWITCH 1WAY	20A 250V~	1M	■ SB сензорен бутон черен soft touch black		0 03
⋮	⋮	⋮	⋮	■ AT антрацит anthracite		
⋮	⋮	⋮	⋮	■ ES сребрист elox silver		
⋮	⋮	⋮	⋮	■ IW слоновя кост ivory white		

КЛЮЧ 1WAY 16AX 250V~ 1M



SM10



- ключ без бутон
- 16 AX 250 V~, тип SM10
- в съответствие с EN 60669-1
- винтови контакти 1,5 - 2,5 mm²

SWITCH 1WAY 16AX 250V~ 1M
- switch without replaceable button
- 16AX 250V~, type SM10
- in accordance with EN 60669-1
- screw contacts 1.5-2.5mm²

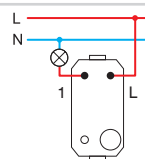

БУТОН 1WAY 16A 250V~ 1M



SM11



- бутон без клавиш за натискане
- 16 A 250 V~, тип SM11
- в съответствие с EN 60669-1
- винтови контакти 1,5 - 2,5 mm²

PUSH BUTTON 1WAY 16A 250V~ 1M
- push button without replaceable button
- 16A 250V~, type SM11
- in accordance with EN 60669-1
- screw contacts 1.5-2.5mm²

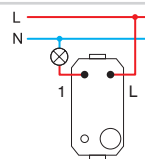

КЛЮЧ 1WAY 20A 250V~ 1M



SM12



- ключ без бутон
- 20 A 250 V~, тип SM12
- в съответствие с EN 60669-1
- винтови контакти 1,5 - 2,5 mm²

SWITCH 1WAY 20A 250V~ 1M
- switch without replaceable button
- 20A 250V~, type SM12
- in accordance with EN 60669-1
- screw contacts 1.5-2.5mm²

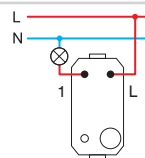

КЛЮЧ 2POLE 16AX 250V~ 1M



SM20

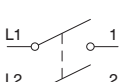

- ключ без бутон
- 16 AX 250 V~, тип SM20
- в съответствие с EN 60669-1
- винтови контакти 1,5 - 2,5 mm²
- само в комбинация с бутон TM15

SWITCH 2POLE 16AX 250V~ 1M
- switch without replaceable button
- 16AX 250V~, type SM20
- in accordance with EN 60669-1
- screw contacts 1.5-2.5mm²
- only in combination with button TM15

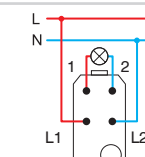

КЛЮЧ ЗА ЩОРИ 1-0-2 16AX 250V~ 1M



SM40

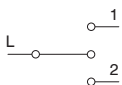

- ключ без бутон
 - 16 AX 250 V~, тип SM40
 - в съответствие с EN 60669-1
 - винтови контакти 1,5 - 2,5 mm²
- SWITCH SHUTTERS 1-0-2 16AX 250V~ 1M**
- switch without replaceable button
 - 16AX 250V~, type SM40
 - in accordance with EN 60669-1
 - screw contacts 1.5-2.5mm²

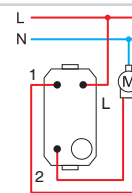

КЛЮЧ ЗА ЩОРИ 1-0-2 16A 250V~ 1M



SM41

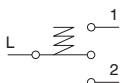

- бутон без клавиш за натискане
 - 16 A 250 V~, тип SM41
 - в съответствие с EN 60669-1
 - винтови контакти 1,5 - 2,5 mm²
- PUSH BUTTON SHUTTERS 1-0-2 16A 250V~ 1M**
- push button without replaceable button
 - 16A 250V~, type SM41
 - in accordance with EN 60669-1
 - screw contacts 1.5-2.5mm²

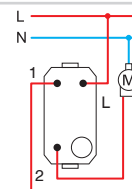

КЛЮЧ 2WAY 16AX 250V~ 1M



SM60

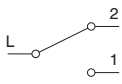

- ключ без бутон
 - 16 AX 250 V~, тип SM60
 - в съответствие с EN 60669-1
 - винтови контакти 1,5 - 2,5 mm²
- SWITCH 2WAY 16AX 250V~ 1M**
- switch without replaceable button
 - 16AX 250V~, type SM60
 - in accordance with EN 60669-1
 - screw contacts 1.5-2.5mm²

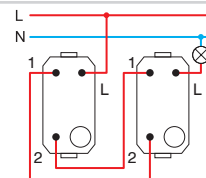

БУТОН 2WAY 16A 250V~ 1M



SM61

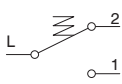

- бутон без клавиш за натискане
 - 16 A 250 V~, тип SM61
 - в съответствие с EN 60669-1
 - винтови контакти 1,5 - 2,5 mm²
- PUSH BUTTON 2WAY 16A 250V~ 1M**
- push button without replaceable button
 - 16A 250V~, type SM61
 - in accordance with EN 60669-1
 - screw contacts 1.5-2.5mm²

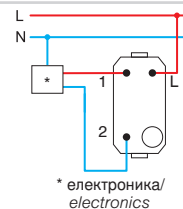

КРЪСТАТ КЛЮЧ 16AX 250V~ 1M



SM70

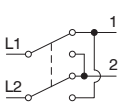

- ключ без бутон
 - 16 AX 250 V~, тип SM70
 - в съответствие с EN 60669-1
 - винтови контакти 1,5 - 2,5 mm²
- SWITCH INTERMEDIATE 16AX 250V~ 1M**
- switch without replaceable button
 - 16AX 250V~, type SM70
 - in accordance with EN 60669-1
 - screw contacts 1.5-2.5mm²

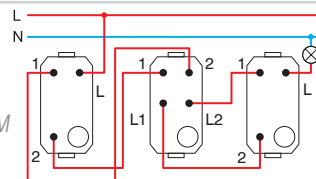

1M = 22,5 x 45
2M = 45 x 45

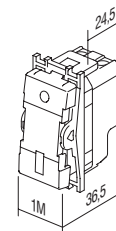
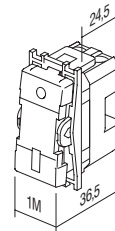



PW снежнобял цвят
polar white



SB сензорен бутон черен
soft touch black



AT антрацит
anthracite



ES сребрист
elox silver



IW слонова кост
ivory white

MW Бял матов цвят
matte white

КЛЮЧ 1WAY 16AX 250V~ 1M



- SM10PW
- SM10MW
- SM10SB
- SM10AT
- SM10ES
- SM10IW

- 16 AX 250 V~, тип SM10
- в съответствие с EN 60669-1
- винтови контакти 1,5 - 2,5 mm²
- сменяем бутон

SWITCH 1WAY 16AX 250V~ 1M
- 16AX 250V~, type SM10
- in accordance with EN 60669-1
- screw contacts 1.5-2.5 mm²
- replaceable button



КЛЮЧ 1WAY 16AX 250V~ 1M __ IN



- SM10PWIN
- SM10MWIN
- SM10SBIN
- SM10ATIN
- SM10ESIN
- SM10IWIN

- IN индикатор
- 16 AX 250 V~, тип SM10
- в съответствие с EN 60669-1
- винтови контакти 1,5 - 2,5 mm²
- лампата не е включена в доставката
- сменяем бутон

SWITCH 1WAY 16AX 250V~ 1M __ IN
- IN indicator
- 16AX 250V~, type SM10
- in accordance with EN 60669-1
- screw contacts 1.5-2.5 mm²
- lamp is not included
- replaceable button



БУТОН 1WAY 16A 250V~ 1M

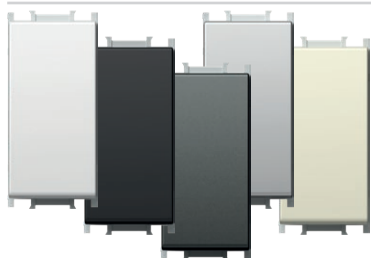

- SM11PW
- SM11MW
- SM11SB
- SM11AT
- SM11ES
- SM11IW

- 16 A 250 V~, тип SM11
- в съответствие с EN 60669-1
- винтови контакти 1,5 - 2,5 mm²
- сменяем бутон

PUSH BUTTON 1WAY 16A 250V~ 1M
- 16A 250V~, type SM11
- in accordance with EN 60669-1
- screw contacts 1.5-2.5 mm²
- replaceable button



БУТОН 1WAY 16A 250V~ 1M __ IN 01



- SM11PWIN01
- SM11MWIN01
- SM11SBIN01
- SM11ATIN01
- SM11ESIN01
- SM11IWIN01

- IN 01 звънчев индикатор
- 16 A 250 V~, тип SM11
- в съответствие с EN 60669-1
- винтови контакти 1,5 - 2,5 mm²
- лампата не е включена в доставката
- сменяем бутон

PUSH BUTTON 1WAY 16A 250V~ 1M __ IN 01
- IN 01 indicator bell
- 16A 250V~, type SM11
- in accordance with EN 60669-1
- screw contacts 1.5-2.5 mm²
- lamp is not included
- replaceable button



БУТОН 1WAY 16A 250V~ 1M __ IN 02



- SM11PWIN02 - IN 02 светлинен индикатор
- SM11MWIN02 - 16 A 250 V~, тип SM11
- SM11SBIN02 - в съответствие с EN 60669-1
- SM11ATIN02 - винтови контакти 1,5 - 2,5 mm²
- SM11ESIN02 - лампата не е включена в доставката
- SM11IWIN02 - сменяем бутон

PUSH BUTTON 1WAY 16A 250V~ 1M __ IN 02

- IN 02 indicator light
- 16A 250V~, type SM11
- in accordance with EN 60669-1
- screw contacts 1.5-2.5 mm²
- lamp is not included
- replaceable button



КЛЮЧ 2POLE 16AX 250V~ 1M __ NT 03



- SM20PWNT03 - NT 03 неутрален 0-1
- SM20MWNT03 - 16 AX 250 V~, тип SM20
- SM20SBNT03 - в съответствие с EN 60669-1
- SM20ATNT03 - винтови контакти 1,5 - 2,5 mm²
- SM20ESNT03 - сменяем бутон
- SM20IWIN03

SWITCH 2POLE 16AX 250V~ 1M __ NT 03

- NT 03 neutral 0-1
- 16AX 250V~, type SM20
- in accordance with EN 60669-1
- screw contacts 1.5-2.5 mm²
- replaceable button



КЛЮЧ 2POLE 16AX 250V~ 1M __ IN



- SM20PWIN - IN индикатор
- SM20MWIN - 16 AX 250 V~, тип SM20
- SM20SBIN - в съответствие с EN 60669-1
- SM20ATIN - винтови контакти 1,5 - 2,5 mm²
- SM20ESIN - лампата не е включена в доставката
- SM20IWIN - сменяем бутон

SWITCH 2POLE 16AX 250V~ 1M __ IN

- IN indicator
- 16AX 250V~, type SM20
- in accordance with EN 60669-1
- screw contacts 1.5-2.5 mm²
- lamp is not included
- replaceable button



КЛЮЧ ЗА ЩОРИ 1-0-2 16AX 250V~ 1M __ NT 10

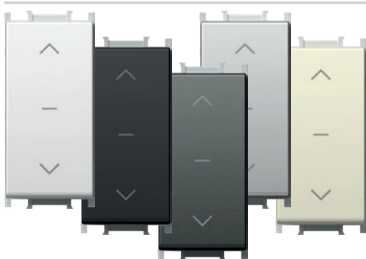

- SM40PWNT10 - NT 10 неутрален 1-0-2
- SM40MWNT10 - 16 AX 250 V~, тип SM40
- SM40SBNT10 - в съответствие с EN 60669-1
- SM40ATNT10 - винтови контакти 1,5 - 2,5 mm²
- SM40ESNT10 - сменяем бутон
- SM40IWIN10

SWITCH SHUTTERS 1-0-2 16AX 250V~ 1M __ NT 10

- NT 10 neutral 1-0-2
- 16AX 250V~, type SM40
- in accordance with EN 60669-1
- screw contacts 1.5-2.5mm²
- replaceable button



БУТОНИ ЗА ЩОРИ 1-0-2 16A 250V~ 1M __ NT 10

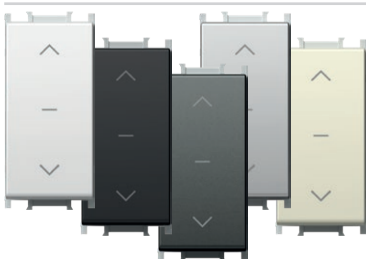

- SM41PWNT10 - NT 10 неутрален 1-0-2
- SM41MWNT10 - 16 A 250 V~, тип SM41
- SM41SBNT10 - в съответствие с EN 60669-1
- SM41ATNT10 - винтови контакти 1,5 - 2,5 mm²
- SM41ESNT10 - сменяем бутон
- SM41IWIN10

PUSH BUTTON SHUTTERS 1-0-2 16A 250V~ 1M __ NT 10

- NT 10 neutral 1-0-2
- 16A 250V~, type SM41
- in accordance with EN 60669-1
- screw contacts 1.5-2.5mm²
- replaceable button



КЛЮЧ 2WAY 16AX 250V~ 1M

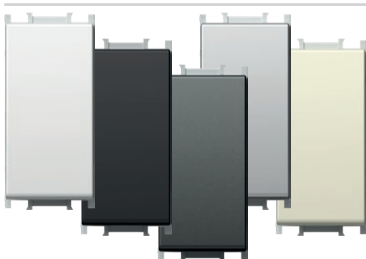

- SM60PW
- SM60MW
- SM60SB
- SM60AT
- SM60ES
- SM60IW

SWITCH 2WAY 16AX 250V~ 1M

- 16 AX 250 V~, тип SM60
- в съответствие с EN 60669-1
- винтови контакти 1,5 - 2,5 mm²
- сменяем бутон



БУТОН 2WAY 16A 250V~ 1M

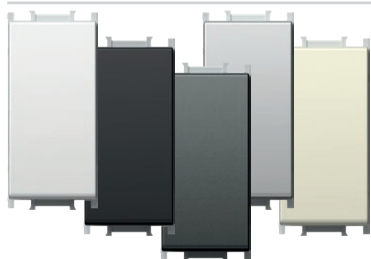

- SM61PW
- SM61MW
- SM61SB
- SM61AT
- SM61ES
- SM61IW

- 16 A 250 V~, тип SM61
 - в съответствие с EN 60669-1
 - винтови контакти 1,5 - 2,5 mm²
 - сменяем бутон

PUSH BUTTON 2WAY 16A 250V~ 1M

- 16A 250V~, type SM61
 - in accordance with EN 60669-1
 - screw contacts 1.5-2.5 mm²
 - replaceable button



БУТОН С ШНУР 2WAY 16A 250V~ 1M



- SM62PWCD
- SM62MWCD
- SM62SBCD
- SM62ATCD
- SM62ESCD
- SM62IWCD

- CD индикатор+шнур
 - дължина на шнура 1.5 m
 - 16 A 250 V~, тип SM62
 - в съответствие с EN 60669-1
 - винтови контакти 1,5 - 2,5 mm²

PUSH BUTTON 2WAY WITH CORD 16A 250V~ 1M __ CD

- CD indicator+cord
 - cord lenght 1.5m
 - 16A 250V~, type SM62
 - in accordance with EN 60669-1
 - screw contacts 1.5-2.5 mm²



КРЪСТАТ КЛЮЧ 16AX 250V~ 1M



- SM70PW
- SM70MW
- SM70SB
- SM70AT
- SM70ES
- SM70IW

- 16 AX 250 V~, тип SM70
 - в съответствие с EN 60669-1
 - винтови контакти 1,5 - 2,5 mm²
 - сменяем бутон

SWITCH INTERMEDIATE 16AX 250V~ 1M

- 16AX 250V~, type SM70
 - in accordance with EN 60669-1
 - screw contacts 1.5-2.5 mm²
 - replaceable button



1M = 22,5 x 45
 2M = 45 x 45

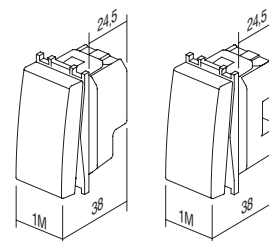

B U T T O N S T M

тип type	описание description	размер size	цвет colour	допълнителна информация 1 optional data 1	допълнителна информация 2 optional data 2
TM11	БУТОН BUTTON	1M	<input type="checkbox"/> PW снежнобял цвят polar white <input type="checkbox"/> MW бял матов цвят matte white <input checked="" type="checkbox"/> SB сензорен бутон черен soft touch black <input type="checkbox"/> AT антрацит anthracite <input type="checkbox"/> ES сребрист elox silver <input type="checkbox"/> IW слонова кост ivory white	NT неутрален neutral IN индикатор indicator	01 02 03
TM12	БУТОН BUTTON	2M			
TM21	КАПАЧЕ BLANK	1M			
:	:	:			
:	:	:			

БУТОН 1M



- TM11PW
- TM11MW
- TM11SB
- TM11AT
- TM11ES
- TM11IW

- сменяем бутон 1M
- в съответствие с EN 60669-1

BUTTON 1M

- replaceable button 1M
- in accordance with EN 60669-1



БУТОН 1M С ИНДИКАТОР



- TM11PWIN
- TM11MWIN
- TM11SBIN
- TM11ATIN
- TM11ESIN
- TM11IWIN

- сменяем бутон 1M
- в съответствие с EN 60669-1

BUTTON 1M INDICATOR

- replaceable button 1M
- in accordance with EN 60669-1



БУТОН 2M

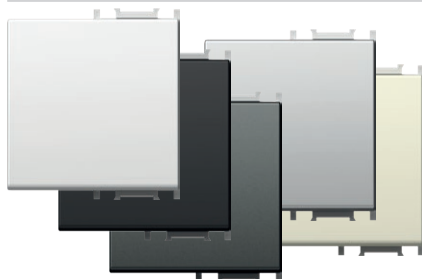

- TM12PW
- TM12MW
- TM12SB
- TM12AT
- TM12ES
- TM12IW

- сменяем бутон 2M с носач за бутон
- за надграждане на ключ или бутон от размер 1M към размер 2M
- в съответствие с EN 60669-1

BUTTON 2M

- replaceable button 2M with button carrier
- to upgrade switch or push button from size 1M to size 2M
- in accordance with EN 60669-1



БУТОН 2M С ИНДИКАТОР

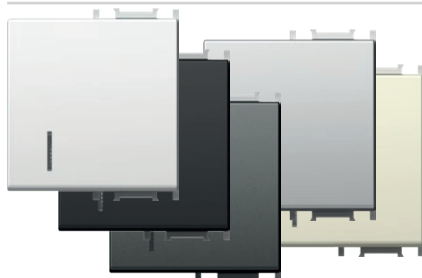

- TM12PWIN
- TM12MWIN
- TM12SBIN
- TM12ATIN
- TM12ESIN
- TM12IWIN

- сменяем бутон 2M с носач за бутон
- за надграждане на ключ или бутон от размер 1M към размер 2M
- в съответствие с EN 60669-1

BUTTON 2M INDICATOR

- replaceable button 2M with button carrier
- to upgrade switch or push button from size 1M to size 2M
- in accordance with EN 60669-1



БУТОН 2М С ПАНЕЛ С НАДПИС

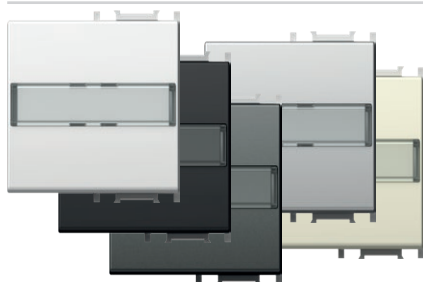

- TM13PWIL
- TM13MWIL
- TM13SBIL
- TM13ATIL
- TM13ESIL
- TM13IWIL

- сменяем бутон 2М с носач за бутон
 - за надграждане на ключ или бутон
 от размер 1М към размер 2М
 - в съответствие с EN 60669-1

BUTTON 2M WITH INSCRIPTION PLATE
 - replaceable button 2M with button carrier
 - to upgrade switch or push button
 from size 1M to size 2M
 - in accordance with EN 60669-1



БУТОН 1М 2ПОЛЕ

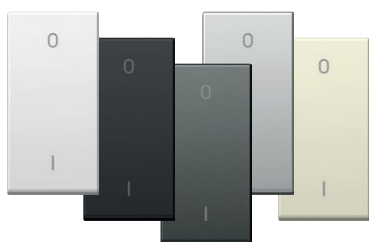

- TM15PW
- TM15MW
- TM15SB
- TM15AT
- TM15ES
- TM15IW

- сменяем бутон 1М
 - само в комбинация с механизъм SM20
 - в съответствие с EN 60669-1

BUTTON 1M 2POLE
 - replaceable button 1M
 - only in combination with mechanism SM20
 - in accordance with EN 60669-1



КАПАЧЕ 1М

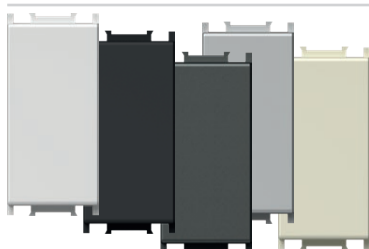

- TM21PW
- TM21MW
- TM21SB
- TM21AT
- TM21ES
- TM21IW

- модулно капаче за покриване на неизползвани позиции
 - в съответствие с EN 60669-1

BLANK 1M
 - blank modul to fill up empty spaces
 - in accordance with EN 60669-1



КАПАЧЕ 2М



- TM22PW
- TM22MW
- TM22SB
- TM22AT
- TM22ES
- TM22IW

- модулно капаче за покриване на неизползвани позиции
 - в съответствие с EN 60669-1

BLANK 2M
 - blank modul to fill up empty spaces
 - in accordance with EN 60669-1



ИЗХОД ЗА КАБЕЛ 1М

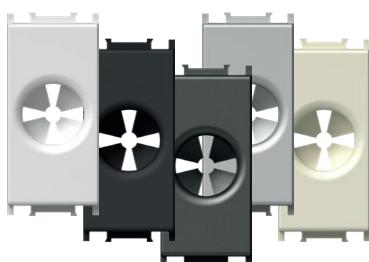

- TM31PW
- TM31MW
- TM31SB
- TM31AT
- TM31ES
- TM31IW

- отвор за изход на кабел
 - в съответствие с EN-60669-1

CABLE OUTLET 1M
 - outlet for cable
 - in accordance with EN-60669-1



1M = 22,5 x 45
 2M = 45 x 45

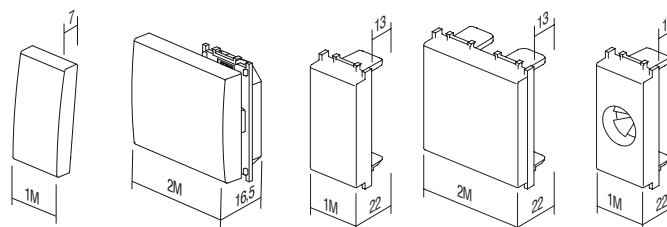

TM11
 TM15

TM12
 TM13

TM21

TM22

TM31

BUTTONS T M

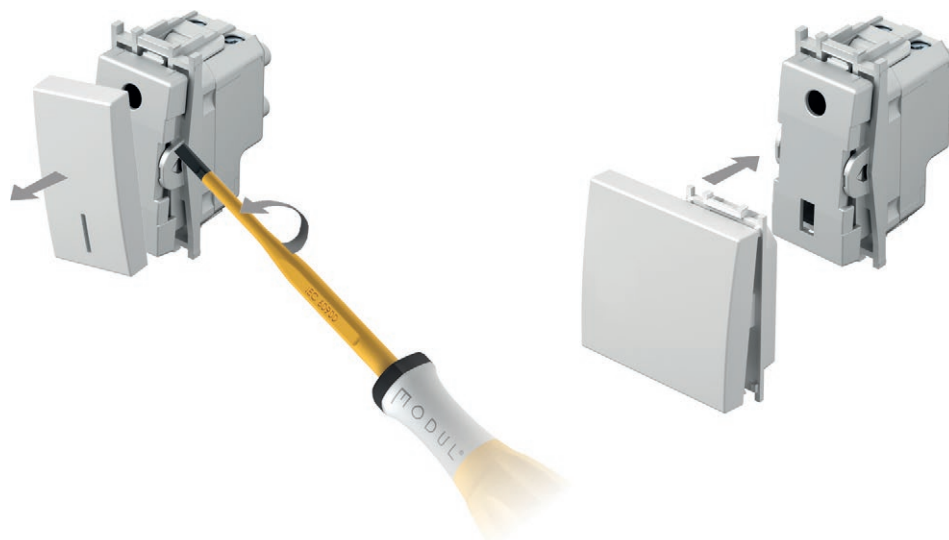

ЛАЗЕРЕН ПЕЧАТ ВЪРХУ БУТОНИ

- лазерно отпечатване на всякакви графични изображения върху маркирани места
- налични стандартни символи, други – по заявка
- LASER PRINT ON BUTTONS**
- laser print of any graphics on marked locations
- standard symbols from stock, other on request

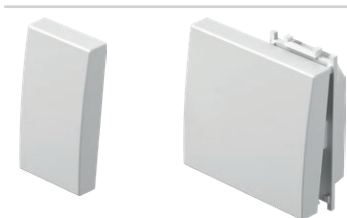

1M	2M
A	A D G
B	B E H
C	C F I

СИМВОЛИ

SYMBOLS

01	02	03	04	05	06	07	08	09	10	11	12	13	14	20	21
													1 0 2	+	-
22	23	24	25	26	27	28	29	30	31	32	33	34	35	36	37
					alarm	alarm	OFF	ON	+				AC		
38	39	40	41	42	43	44	45	46	47	48					

СТАНДАРТНИ СИМВОЛИ

STANDARD SYMBOLS

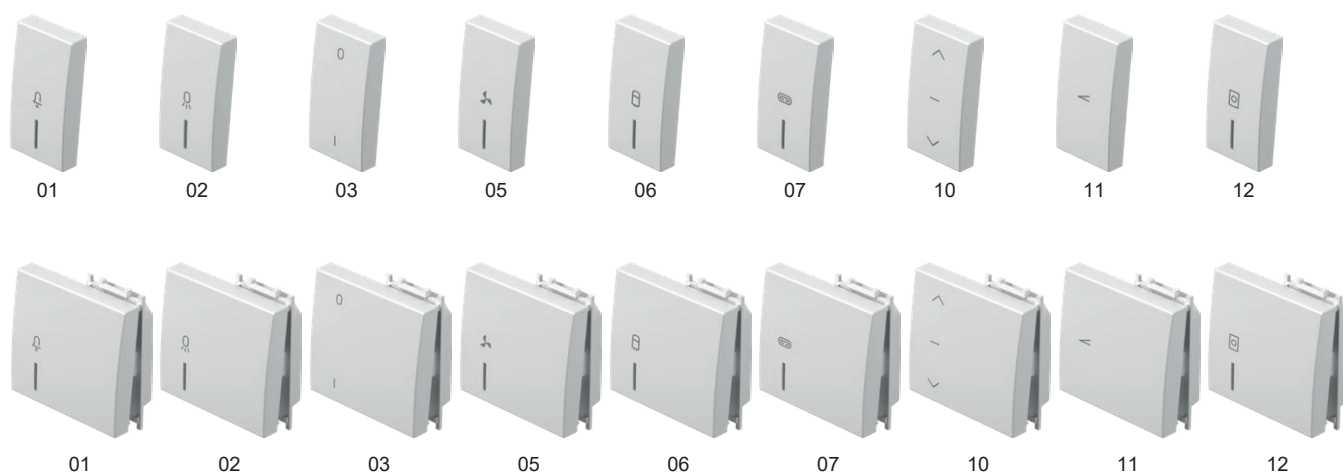

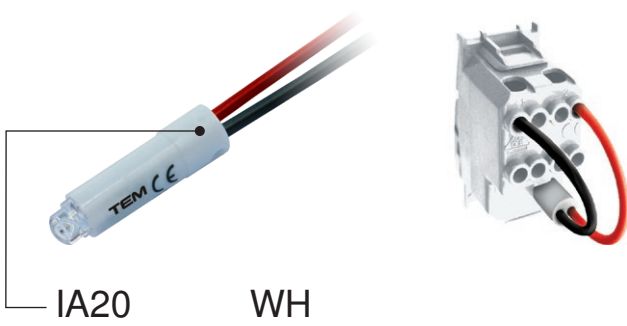

тип type	описание description	технически данни technical data	цвет colour
IA10	НЕОНОВА ЛАМПА NEON LAMP	230V~ 0,34W	<input type="checkbox"/> WH бял цвят white
IA20	СВЕТОДИОДНА СИГНАЛИЗАЦИЯ LED SIGNALLING UNIT	230V~ AC/DC 0,40W	<input checked="" type="checkbox"/> BL син цвят blue
IA21	СВЕТОДИОДНА СИГНАЛИЗАЦИЯ LED SIGNALLING UNIT	24V AC/DC 0,20W	<input checked="" type="checkbox"/> RD червен red
·	·	·	<input checked="" type="checkbox"/> GR зелен green
·	·	·	<input checked="" type="checkbox"/> OR оранжев orange

НЕОНОВА ЛАМПА 230 V~ 0,34 W

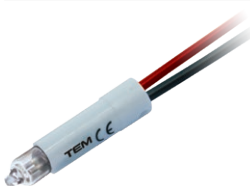

IA10OR

- за индикиране, сигнализация или постоянна сигнализация
- в съчетание с бутон с индикатор

NEON LAMP 230V~ 0,34W

- for indication, signalling or permanent signalling
- in combination with a button featuring an indicator

СВЕТОДИОДНА СИГНАЛИЗАЦИЯ 230 V AC/DC 0,40 W

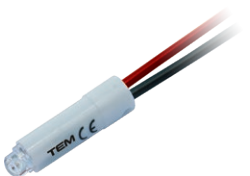

- IA20WH
- IA20GR
- IA20RD
- IA20BL

- за индикиране, сигнализация или постоянна сигнализация
- в съчетание с бутон с индикатор

LED SIGNALLING UNIT 230V AC/DC 0,40W

- for indication, signalling or permanent signalling
- in combination with a button featuring an indicator

СВЕТОДИОДНА СИГНАЛИЗАЦИЯ 24 V AC/DC 0,20 W

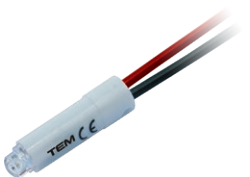

- IA21WH
- IA21RD

- за индикиране, сигнализация или постоянна сигнализация
- в съчетание с бутон с индикатор

LED SIGNALLING UNIT LAMP 24V AC/DC 0,20W

- for indication, signalling or permanent signalling
- in combination with a button featuring an indicator

СВЕТОДИОДНА СИГНАЛИЗАЦИЯ 12 V AC/DC 0,10 W

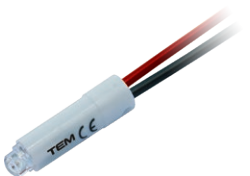

- IA22WH
- IA22RD

- за индикиране, сигнализация или постоянна сигнализация
- в съчетание с бутон с индикатор

LED SIGNALLING UNIT 12V AC/DC 0,10W

- for indication, signalling or permanent signalling
- in combination with a button featuring an indicator

RC ВЕРИГА 250 V~



IA50

- RC верига за отстраняване на смущенията при работата на LED лампи
- възможно е успоредно свързване на няколко RC вериги с лампи
- 0,1 μF, 100 Ω, 250 V~

RC CIRCUIT 250V~

- RC circuit to eliminate disturbances in the operation of LED lamps
- parallel connections of more RC circuits with lamps are possible
- 0,1 μF, 100 Ω, 250V~

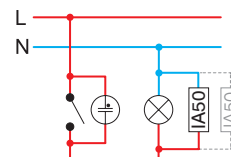

индикация /
Indication

* Сигнализация /
Signalization

Постоянна сигнализация /
Permanent signalling

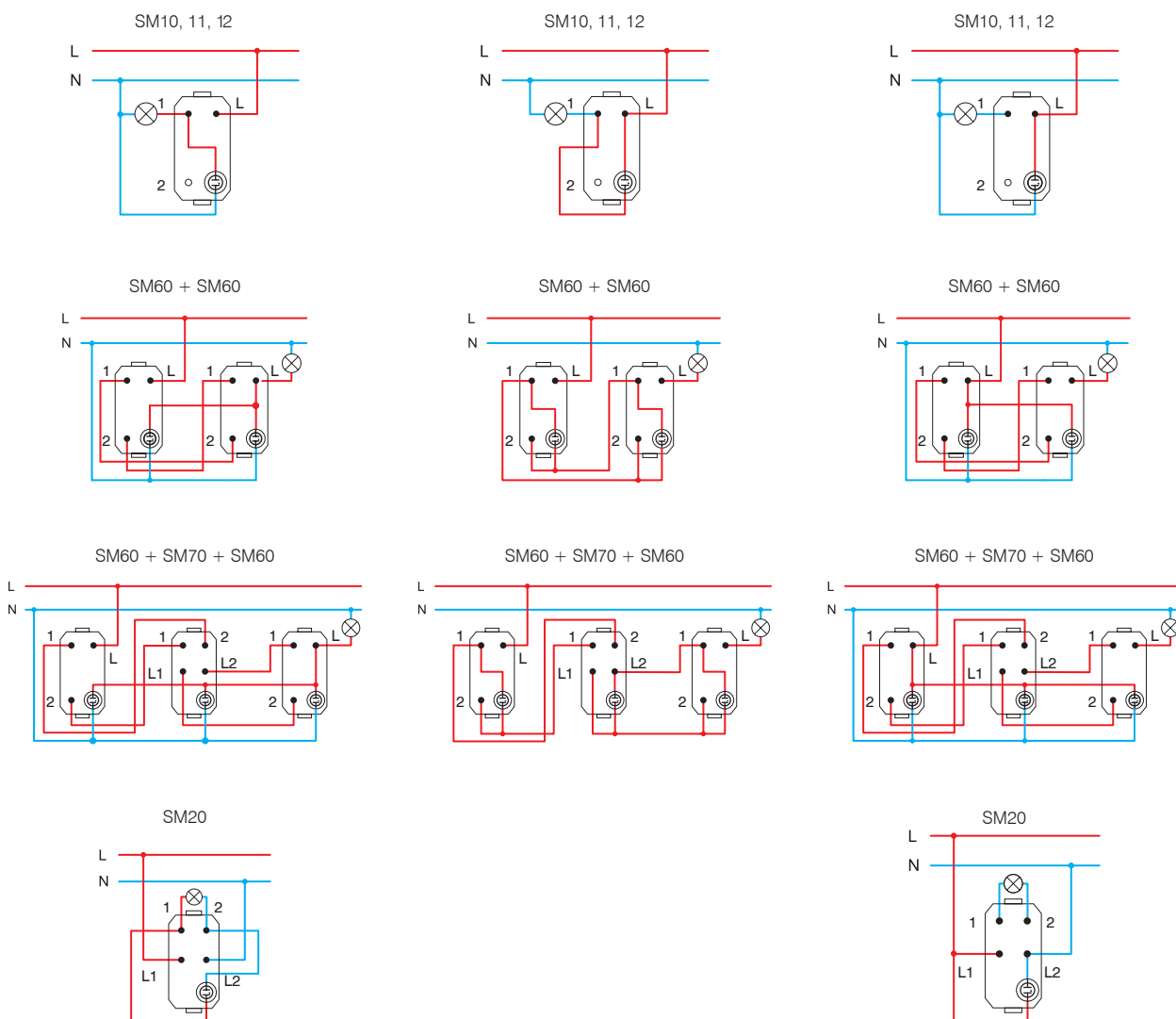

* връзките не са подходящи за енергоспестяващи крушки (CFL, LED) /
the connections are not suitable for energy-saving bulbs (CFL, LED)

1M = 22,5 x 45
2M = 45 x 45

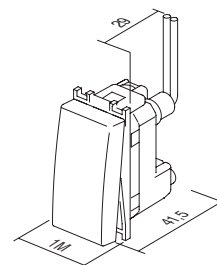

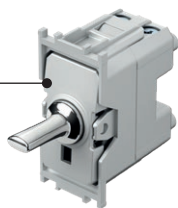

SP10

PC

Тип type	Наименование description	Техническо описание technical data	Размер size	Цвят на щифтовете pin colour
SP10	ЕДНОПОЛЮСОВ КЛЮЧ SWITCH 1WAY	16AX 250V~	1M	■ PC Хром chrome
SP11	ЕДНОПОЛЮСОВ БУТОН PUSH BUTTON 1WAY	16A 250V~	1M	■ PA Антрацитен anthracite
SP12	ЕДНОПОЛЮСОВ КЛЮЧ SWITCH 1WAY	20A 250V~	1M	■ PB Черен black
·	·	·	·	■ PG Златен gold

ЕДНОПОЛЮСОВ КЛЮЧ 16AX 250V~ 1M



- SP10PC
- SP10PA
- SP10PB
- SP10PG

- ключ
- 16AX 250V~, тип SP10
- съответства на EN 60669-1
- прикрепване на проводниците с винт 1,5-2,5 мм²

SWITCH 1WAY 16AX 250V~ 1M
- switch
- 16AX 250V~, type SP10
- in accordance with EN 60669-1
- screw contacts 1.5-2.5mm²

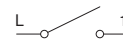
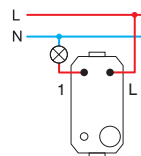

ЕДНОПОЛЮСОВ КЛЮЧ 16A 250V~ 1M



- SP11PC
- SP11PA
- SP11PB
- SP11PG

- бутон
- 16A 250V~, тип SP11
- съответства на EN 60669-1
- прикрепване на проводниците с винт 1,5-2,5 мм²

PUSH BUTTON 1WAY 16A 250V~ 1M
- push button
- 16A 250V~, type SP11
- in accordance with EN 60669-1
- screw contacts 1.5-2.5mm²

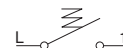
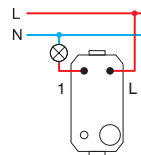

ЕДНОПОЛЮСОВ КЛЮЧ 20A 250V~ 1M



- SP12PC
- SP12PA
- SP12PB
- SP12PG

- ключ
- 20A 250V~, тип SP12
- съответства на EN 60669-1
- прикрепване на проводниците с винт 1,5-2,5 мм²

SWITCH 1WAY 20A 250V~ 1M
- switch
- 20A 250V~, type SP12
- in accordance with EN 60669-1
- screw contacts 1.5-2.5mm²

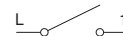
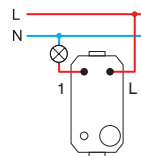

ДВУПОЛЮСЕН КЛЮЧ 16AX 250V~ 1M



- SP20PC
- SP20PA
- SP20PB
- SP20PG

- ключ
- 16AX 250V~, тип SP20
- съответства на EN 60669-1
- прикрепване на проводниците с винт 1,5-2,5 мм²

SWITCH 2POLE 16AX 250V~ 1M
- switch
- 16AX 250V~, type SP20
- in accordance with EN 60669-1
- screw contacts 1.5-2.5mm²

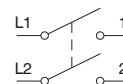
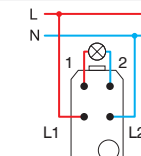

S W I T C H E S S P



- SP40PC
- SP40PA
- SP40PB
- SP40PG

КЛЮЧ ЗА ЩОРИ 1-0-2 16AX 250V~ 1M

- ключ
- 16AX 250V~, тип SP40
- съответства на EN 60669-1
- прикрепване на проводниците с винт 1,5-2,5 мм²

SWITCH SHUTTERS 1-0-2 16AX 250V~ 1M

- switch
- 16AX 250V~, type SP40
- in accordance with EN 60669-1
- screw contacts 1.5-2.5mm²

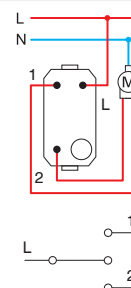

- SP41PC
- SP41PA
- SP41PB
- SP41PG

БУТОН ЗА ЩОРИ 1-0-2 16A 250V~ 1M

- бутон
- 16A 250V~, тип SP41
- съответства на EN 60669-1
- прикрепване на проводниците с винт 1,5-2,5 мм²

PUSH BUTTON SHUTTERS 1-0-2 16A 250V~ 1M

- push button
- 16A 250V~, type SP41
- in accordance with EN 60669-1
- screw contacts 1.5-2.5mm²

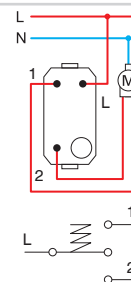

- SP60PC
- SP60PA
- SP60PB
- SP60PG

РОТАЦИОНЕН КЛЮЧ 16AX 250V~ 1M

- ключ
- 16AX 250V~, тип SP60
- съответства на EN 60669-1
- прикрепване на проводниците с винт 1,5-2,5 мм²

SWITCH 2WAY 16AX 250V~ 1M

- switch
- 16AX 250V~, type SP60
- in accordance with EN 60669-1
- screw contacts 1.5-2.5mm²

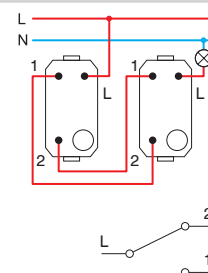

- SP61PC
- SP61PA
- SP61PB
- SP61PG

РОТАЦИОНЕН КЛЮЧ 16A 250V~ 1M

- бутон
- 16A 250V~, тип SP61
- съответства на EN 60669-1
- прикрепване на проводниците с винт 1,5-2,5 мм²

PUSH BUTTON 2WAY 16A 250V~ 1M

- push button
- 16A 250V~, type SP61
- in accordance with EN 60669-1
- screw contacts 1.5-2.5mm²

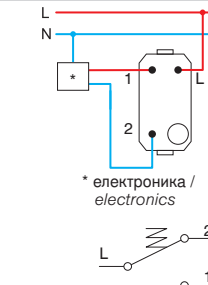

- SP70PC
- SP70PA
- SP70PB
- SP70PG

КРЪСТАТ КЛЮЧ 16AX 250V~ 1M

- ключ
- 16AX 250V~, тип SP70
- съответства на EN 60669-1
- прикрепване на проводниците с винт 1,5-2,5 мм²

SWITCH INTERMEDIATE 16AX 250V~ 1M

- switch
- 16AX 250V~, type SP70
- in accordance with EN 60669-1
- screw contacts 1.5-2.5mm²

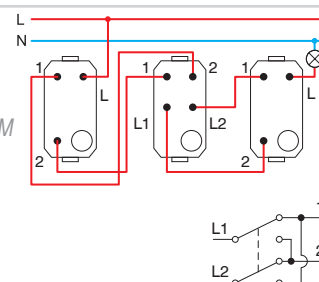

1M= 22,5 x 45

- SP10
- SP11
- SP12
- SP40
- SP41
- SP60
- SP61

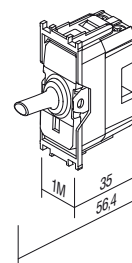

- SP20
- SP70

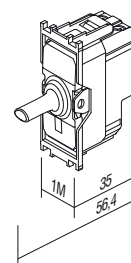

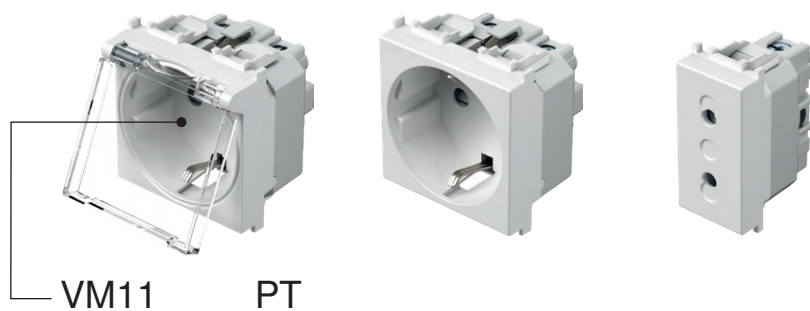

тип type	описание description	технически данни technical data	размер size	цвет colour																																										
VM10	КОНТАКТ ШУКО+KS SOCKET SCHUKO+KS	2P+E 16A 250V~	2M	<table border="0"> <tr> <td><input type="checkbox"/> PW</td> <td>снежнобял polar white</td> <td><input checked="" type="checkbox"/> PT</td> <td>бял + прозрачен white+transparent</td> <td><input type="checkbox"/> PP</td> <td>бял+бял white+white</td> </tr> </table>	<input type="checkbox"/> PW	снежнобял polar white	<input checked="" type="checkbox"/> PT	бял + прозрачен white+transparent	<input type="checkbox"/> PP	бял+бял white+white																																				
<input type="checkbox"/> PW	снежнобял polar white	<input checked="" type="checkbox"/> PT	бял + прозрачен white+transparent	<input type="checkbox"/> PP	бял+бял white+white																																									
VM11	КОНТАКТ ШУКО+KS+КАПАК SOCKET SCHUKO+KS+COVER	2P+E 16A 250V~	2M	<table border="0"> <tr> <td><input type="checkbox"/> MW</td> <td>Бял матов matte white</td> <td><input checked="" type="checkbox"/> MT</td> <td>бял + прозрачен white+transparent</td> <td><input type="checkbox"/> MM</td> <td>бял+бял white+white</td> </tr> </table>	<input type="checkbox"/> MW	Бял матов matte white	<input checked="" type="checkbox"/> MT	бял + прозрачен white+transparent	<input type="checkbox"/> MM	бял+бял white+white																																				
<input type="checkbox"/> MW	Бял матов matte white	<input checked="" type="checkbox"/> MT	бял + прозрачен white+transparent	<input type="checkbox"/> MM	бял+бял white+white																																									
VM20	КОНТАКТ EURO+KS SOCKET EURO+KS	2P 10A 250V~	1M	<table border="0"> <tr> <td><input checked="" type="checkbox"/> SB</td> <td>черен soft touch black</td> <td><input checked="" type="checkbox"/> BT</td> <td>черен + прозрачен soft touch black+transparent</td> <td><input checked="" type="checkbox"/> BB</td> <td>черен+черен soft touch black+black</td> </tr> <tr> <td><input checked="" type="checkbox"/> AT</td> <td>антрацит anthracite</td> <td><input checked="" type="checkbox"/> AT</td> <td>антрацит + прозрачен anthracite+transparent</td> <td><input checked="" type="checkbox"/> AA</td> <td>антрацит+прозрачен anthracite+anthracite</td> </tr> <tr> <td><input checked="" type="checkbox"/> ES</td> <td>сребрист elox silver</td> <td><input checked="" type="checkbox"/> ST</td> <td>сребрист + прозрачен silver+transparent</td> <td><input checked="" type="checkbox"/> SS</td> <td>сребрист+сребрист silver+silver</td> </tr> <tr> <td><input checked="" type="checkbox"/> IW</td> <td>слонова кост ivory white</td> <td><input checked="" type="checkbox"/> IT</td> <td>слонова кост + прозрачен ivory+transparent</td> <td><input checked="" type="checkbox"/> II</td> <td>слонова кост+слонова кост ivory+ivory</td> </tr> <tr> <td><input checked="" type="checkbox"/> RD</td> <td>червен red</td> <td><input checked="" type="checkbox"/> RT</td> <td>червен + прозрачен red+transparent</td> <td><input checked="" type="checkbox"/> RR</td> <td>червен+червен red+red</td> </tr> <tr> <td><input checked="" type="checkbox"/> GR</td> <td>зелен green</td> <td><input checked="" type="checkbox"/> GT</td> <td>зелен + прозрачен green+transparent</td> <td><input checked="" type="checkbox"/> GG</td> <td>зелен+зелен green+green</td> </tr> <tr> <td><input checked="" type="checkbox"/> OR</td> <td>оранжев orange</td> <td><input checked="" type="checkbox"/> OT</td> <td>оранжев + прозрачен orange+transparent</td> <td><input checked="" type="checkbox"/> OO</td> <td>оранжев+оранжев orange+orange</td> </tr> </table>	<input checked="" type="checkbox"/> SB	черен soft touch black	<input checked="" type="checkbox"/> BT	черен + прозрачен soft touch black+transparent	<input checked="" type="checkbox"/> BB	черен+черен soft touch black+black	<input checked="" type="checkbox"/> AT	антрацит anthracite	<input checked="" type="checkbox"/> AT	антрацит + прозрачен anthracite+transparent	<input checked="" type="checkbox"/> AA	антрацит+прозрачен anthracite+anthracite	<input checked="" type="checkbox"/> ES	сребрист elox silver	<input checked="" type="checkbox"/> ST	сребрист + прозрачен silver+transparent	<input checked="" type="checkbox"/> SS	сребрист+сребрист silver+silver	<input checked="" type="checkbox"/> IW	слонова кост ivory white	<input checked="" type="checkbox"/> IT	слонова кост + прозрачен ivory+transparent	<input checked="" type="checkbox"/> II	слонова кост+слонова кост ivory+ivory	<input checked="" type="checkbox"/> RD	червен red	<input checked="" type="checkbox"/> RT	червен + прозрачен red+transparent	<input checked="" type="checkbox"/> RR	червен+червен red+red	<input checked="" type="checkbox"/> GR	зелен green	<input checked="" type="checkbox"/> GT	зелен + прозрачен green+transparent	<input checked="" type="checkbox"/> GG	зелен+зелен green+green	<input checked="" type="checkbox"/> OR	оранжев orange	<input checked="" type="checkbox"/> OT	оранжев + прозрачен orange+transparent	<input checked="" type="checkbox"/> OO	оранжев+оранжев orange+orange
<input checked="" type="checkbox"/> SB	черен soft touch black	<input checked="" type="checkbox"/> BT	черен + прозрачен soft touch black+transparent	<input checked="" type="checkbox"/> BB	черен+черен soft touch black+black																																									
<input checked="" type="checkbox"/> AT	антрацит anthracite	<input checked="" type="checkbox"/> AT	антрацит + прозрачен anthracite+transparent	<input checked="" type="checkbox"/> AA	антрацит+прозрачен anthracite+anthracite																																									
<input checked="" type="checkbox"/> ES	сребрист elox silver	<input checked="" type="checkbox"/> ST	сребрист + прозрачен silver+transparent	<input checked="" type="checkbox"/> SS	сребрист+сребрист silver+silver																																									
<input checked="" type="checkbox"/> IW	слонова кост ivory white	<input checked="" type="checkbox"/> IT	слонова кост + прозрачен ivory+transparent	<input checked="" type="checkbox"/> II	слонова кост+слонова кост ivory+ivory																																									
<input checked="" type="checkbox"/> RD	червен red	<input checked="" type="checkbox"/> RT	червен + прозрачен red+transparent	<input checked="" type="checkbox"/> RR	червен+червен red+red																																									
<input checked="" type="checkbox"/> GR	зелен green	<input checked="" type="checkbox"/> GT	зелен + прозрачен green+transparent	<input checked="" type="checkbox"/> GG	зелен+зелен green+green																																									
<input checked="" type="checkbox"/> OR	оранжев orange	<input checked="" type="checkbox"/> OT	оранжев + прозрачен orange+transparent	<input checked="" type="checkbox"/> OO	оранжев+оранжев orange+orange																																									



КОНТАКТ ШУКО+KS 2P+E 16 A 250 V~ 2M

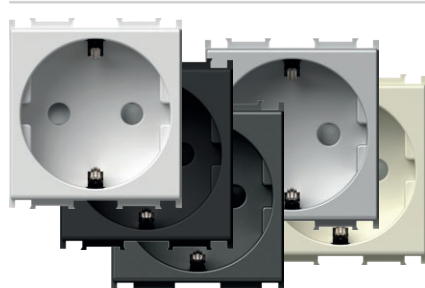

- VM10PW
- VM10MW
- VM10SB
- VM10AT
- VM10ES
- VM10IW

- 2P+E шуко
- 16 A 250 V~, тип VM10
- в съответствие с IEC 60884-1, CEE7
- винтови контакти 1,5 - 2,5 mm²
- Вградена защита от допир на контакти

SOCKET SCHUKO+KS 2P+E 16A 250V~ 2M

- 2P+E schuko
- 16A 250V~, type VM10
- in accordance with IEC 60884-1, CEE7
- screw contacts 1.5-2.5 mm²
- shuttered live contacts



КОНТАКТ ШУКО+KS 2P+E 16 A 250 V~ 2M

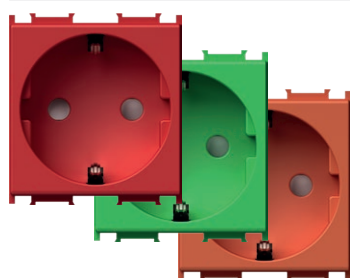

- VM10RD
- VM10GR
- VM10OR

- 2P+E шуко, 16 A 250 V~, тип VM10
- в съответствие с IEC 60884-1, CEE7
- винтови контакти 1,5 - 2,5 mm²
- Вградена защита от допир на контакти

SOCKET SCHUKO+KS 2P+E 16A 250V~ 2M

- 2P+E schuko
- 16A 250V~, type VM10
- in accordance with IEC 60884-1, CEE7
- screw contacts 1.5-2.5 mm²
- shuttered live contacts



КОНТАКТ ШУКО+KS+КАПАК 2P+E 16A 250V~ 2M



- VM11PT
- VM11MT
- VM11BT
- VM11AT
- VM11ST
- VM11IT
- VM11PP

- 2P+E шуко+капак, 16A 250V~, тип VM11
- в съответствие с IEC 60884-1, CEE7
- винтови контакти 1,5 - 2,5 mm²
- Вградена защита от допир на контакти

SOCKET SCHUKO+KS+COVER

- 2P+E 16A 250V~ 2M
- 2P+E schuko+cover
- 16A 250V~, type VM11
- in accordance with IEC 60884-1, CEE7
- screw contacts 1.5-2.5 mm²
- shuttered live contacts



S O C K E T S V M

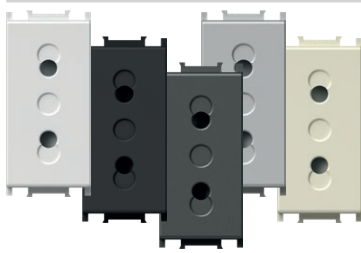

- VM20PW
- VM20MW
- VM20SB
- VM20AT
- VM20ES
- VM20IW

КОНТАКТ EURO+KS 2P 10 A 250 V~ 1M

- 2P Euro, 10 A 250 V~, тип VM20
- в съответствие с IEC 60884-1, CEE7
- винтови контакти 1,5 - 2,5 mm²
- Вградена защита от допир на контакти



SOCKET EURO+KS 2P 10A 250V~ 1M

- 2P Euro
- 10A 250V~, type VM20
- in accordance with IEC 60884-1, CEE7
- screw contacts 1.5-2.5 mm²
- shuttered live contacts

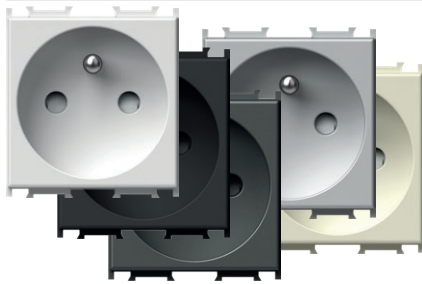

- VM40PW
- VM40MW
- VM40SB
- VM40AT
- VM40ES
- VM40IW

ФРЕНСКИ КОНТАКТ +KS 2P+E 16 A 250 V~ 2M

- 2P+E френски контакт, 16 A 250 V~, тип VM40
- в съответствие с IEC 60884-1, NF C 61-314, CEE7
- винтови контакти 1,5 - 2,5 mm²
- Вградена защита от допир на контакти



SOCKET FRENCH+KS 2P+E 16A 250V~ 2M

- 2P+E French
- 16A 250V~, type VM40
- in accordance with IEC 60884-1, NF C 61-314, CEE7
- screw contacts 1.5-2.5 mm²
- shuttered live contacts

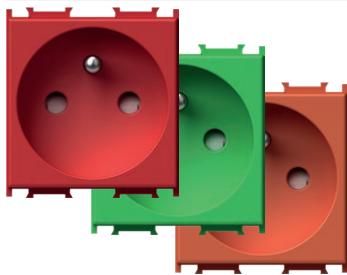

- VM40RD
- VM40GR
- VM40OR

ФРЕНСКИ КОНТАКТ +KS 2P+E 16 A 250 V~ 2M

- 2P+E френски контакт, 16 A 250 V~, тип VM40
- в съответствие с IEC 60884-1, NF C 61-314, CEE7
- винтови контакти 1,5 - 2,5 mm²
- Вградена защита от допир на контакти



SOCKET FRENCH+KS 2P+E 16A 250V~ 2M

- 2P+E French
- 16A 250V~, type VM40
- in accordance with IEC 60884-1, NF C 61-314, CEE7
- screw contacts 1.5-2.5 mm²
- shuttered live contacts



- VM41PT
- VM41MT
- VM41BT
- VM41AT
- VM41PP
- VM41ST
- VM41IT

ФРЕНСКИ КОНТАКТ+KS+КАПАК 2P+E 16A 250V~ 2M

- 2P+E френски контакт+капак, 16A 250V~, тип VM41
- в съответствие с IEC 60884-1, NF C 61-314, CEE7
- винтови контакти 1,5 - 2,5 mm²
- Вградена защита от допир на контакти

SOCKET FRENCH+KS+COVER
2P+E 16A 250V~ 2M

- 2P+E French+cover
- 16A 250V~, type VM41
- in accordance with IEC 60884-1, NF C 61-314, CEE7
- screw contacts 1.5-2.5 mm²
- shuttered live contacts

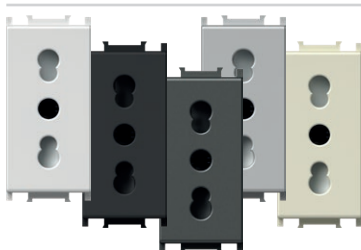

- VM30PW
- VM30MW
- VM30SB
- VM30AT
- VM30ES
- VM30IW

ИТАЛИАНСКИ КОНТАКТ P17/11+KS 2P+E 16 A 250 V~ 1M

- 2P+E Италиански контакт P17/11, 16 A 250 V~, тип VM30
- в съответствие с IEC 60884-1, CEI 23-50
- винтови контакти 1,5 - 2,5 mm²
- Вградена защита от допир на контакти



SOCKET ITALIAN P17/11+KS 2P+E 16A 250V~ 1M

- 2P+E Italian P17/11
- 16A 250V~, type VM30
- in accordance with IEC 60884-1, CEI 23-50
- screw contacts 1.5-2.5 mm²
- shuttered live contacts

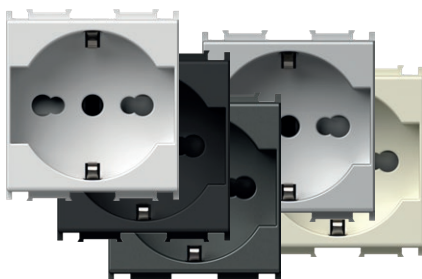

- VM31PW
- VM31MW
- VM31SB
- VM31AT
- VM31ES
- VM31IW

КОНТАКТ SCHUKO/ITA P17/11+KS 2P+E 16A 250V~ 2M

- 2P+E/контакт шуко/италиански P17/11, 16A 250V~, тип VM31
- в съответствие с IEC 60884-1, CEI 23-50
- винтови контакти 1,5 - 2,5 mm²
- Вградена защита от допир на контакти

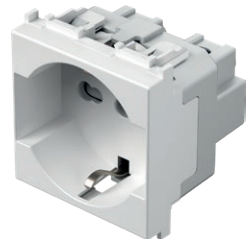
SOCKET SCHUKO/ITA P17/11+KS
2P+E 16A 250V~ 2M

- 2P+E schuko/Italian P17/11
- 16A 250V~, type VM31
- in accordance with IEC 60884-1, CEI 23-50
- screw contacts 1.5-2.5 mm²
- shuttered live contacts

КОНТАКТ ШУКО/ИТА P30+KS 2P+E 16A 250V~ 2M

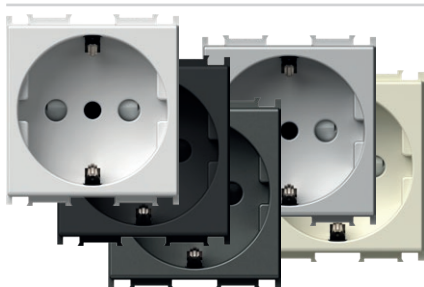

- VM32PW
- VM32MW
- VM32SB
- VM32AT
- VM32ES
- VM32IW

- 2P+E контакт шуко/италиански P30, 16A 250V~, тип VM32
- в съответствие с IEC 60884-1, CEI 23-50
- винтови контакти 1,5 - 2,5 mm²
- Вградена защита от допир на контакти



SOCKET SCHUKO/ITA P30+KS 2P+E 16A 250V~ 2M

- 2P+E schuko/Italian P30
- 16A 250V~, type VM32
- in accordance with IEC 60884-1, CEI 23-50
- screw contacts 1.5-2.5 mm²
- shuttered live contacts

ИТАЛИАНСКИ КОНТАКТ P11+KS 2P+E 10 A 250 V~ 1M

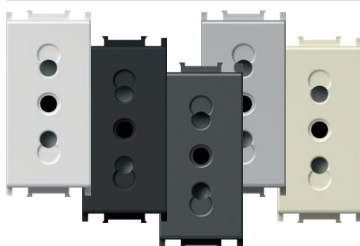

- VM33PW
- VM33MW
- VM33SB
- VM33AT
- VM33ES
- VM33IW

- 2P+E Италиански контакт P11, 10 A 250 V~, тип VM33
- в съответствие с IEC 60884-1, CEI 23-50
- винтови контакти 1,5 - 2,5 mm²
- Вградена защита от допир на контакти



SOCKET ITALIAN P11+KS 2P+E 10A 250V~ 1M

- 2P+E Italian P11
- 10A 250V~, type VM33
- in accordance with IEC 60884-1, CEI 23-50
- screw contacts 1.5-2.5 mm²
- shuttered live contacts

КОНТАКТ EURO/АМЕРИКАНСКИ+KS 2P 16 A 250 V~ 1M

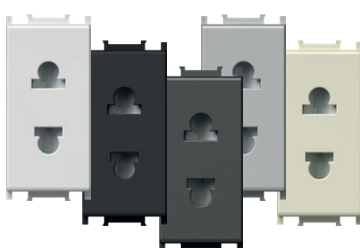

- VM21PW
- VM21MW
- VM21SB
- VM21AT
- VM21ES
- VM21IW

- 2P Euro/американски, 16 A 250 V~, тип VM21
- винтови контакти 1,5 - 2,5 mm²
- Вградена защита от допир на контакти
- само за страни, които не са членки в ЕС



SOCKET EURO/AMERICAN+KS 2P 16A 250V~ 1M

- 2P Euro/American
- 16A 250V~, type VM21
- screw contacts 1.5-2.5 mm²
- shuttered live contacts
- only for countries not members of EU

БРИТАНСКИ КОНТАКТ BS 1363-2+KS 2P+E 13 A 250 V~ 2M

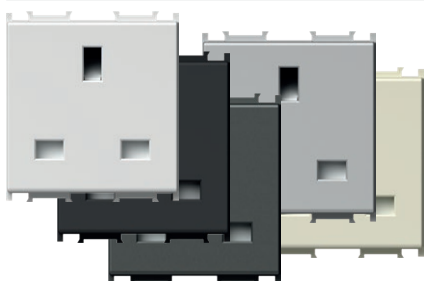

- VM52PW
- VM52MW
- VM52SB
- VM52AT
- VM52ES
- VM52IW

- 2P+E британски контакт BS 1363-2, 13 A 250 V~, тип VM52
- в съответствие с BS 1363-2
- винтови контакти 1,5 - 4 mm²
- Вградена защита от допир на контакти

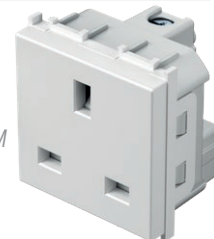

SOCKET BRITISH BS 1363-2+KS 2P+E 13A 250V~ 2M

- 2P+E British BS 1363-2
- 13A 250V~, type VM52
- in accordance with BS 1363-2
- screw contacts 1.5-4 mm²
- shuttered live contacts

КОНТАКТ МУЛТИСТАНДАРТНИЯТ+KS 2P+E 13A 250V~ 2M

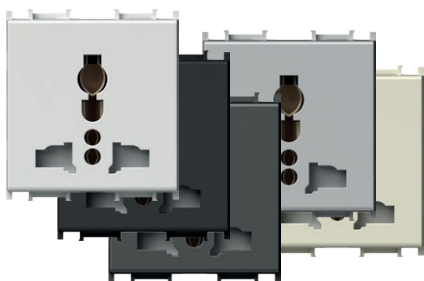

- VM55PW
- VM55MW
- VM55SB
- VM55AT
- VM55ES
- VM55IW

- контакти чрез вкарване 1,5 - 2,5 mm²
- Вградена защита от допир на контакти

SOCKET MULTI-STANDARD+KS 2P+E 13A 250V~ 2M

- plug-in contacts 1.5-2.5 mm²
- shuttered live contacts



УСТРОЙСТВО ЗА ЗАЩИТА СРЕЩУ ОТСКОЦИ НА НАПРЕЖЕНИЕТО MPE MINI 275 V/50 Hz

VM80



- успоредно свързване с първия контакт в реда
- клас на защита III
- U_c=275Vac, U_{oc}/I_{sc}=6kV/3kA, U_p<800V
- в съответствие с IEC 61643-1
- проводници 1,5 mm², IP20
- звук сигнал при прекъсване





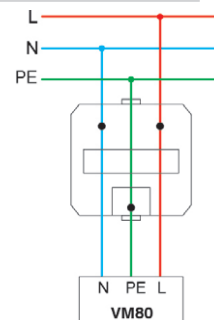





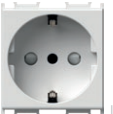

SURGE PROTECTOR MPE MINI 275V/50Hz

- parallel connection with the first socket in the row
- protection class III
- U_c=275V~, U_{oc}/I_{sc}=6kV/3kA, U_p<800V
- in accordance with IEC 61643-1
- wires 1.5mm², IP20
- sound signal at breakdown







S O C K E T S V M

СЪОТВЕТСТВИЕ НА КОНТАКТИ И ЩЕПСЕЛИ
SOCKETS AND PLUGS MATCHING

КОНТАКТ / SOCKET									
ТИП НА ЩЕПСЕЛА / PLUG STYLE	VM10 VM11	VM20	VM30	VM33	VM31	VM32	VM40 VM41	VM21	VM55
Немски / German 	•				•	•			•
Френски / French 	•				•	•	•		•
Италиански / Italian S11 			•	•	•	•			•
Италиански / Italian S17 			•		•				•
euro 	•	•	•		•	•	•	•	•

СЪОТВЕТСТВИЕ НА КОНТАКТИ И ЩЕПСЕЛИ
SOCKETS AND PLUGS MATCHING

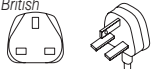
КОНТАКТ / SOCKET			
ТИП НА ЩЕПСЕЛА / PLUG STYLE	VM21	VM52	VM55
Американски / American 	•		•
Британски / British BS 1363-2 		•	•

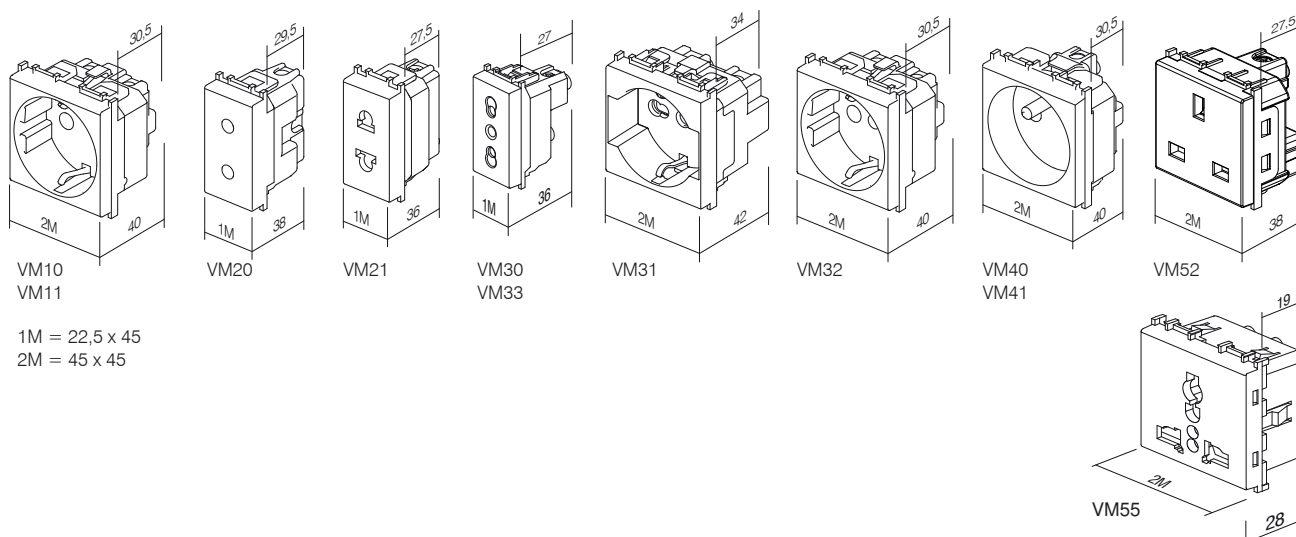



тип type	описание description	технически данни technical data	размер size	цвет colour
KM10	КОНЕКТОР ЗА ТВ ОСНОВЕН SOCKET TV BASIC	0dB	1M	<input type="checkbox"/> PW снежнобял цвят polar white
KM11	КОНЕКТОР ЗА ТВ КРАЕН SOCKET TV END-LINE	1dB	1M	<input type="checkbox"/> MW Бял матов цвят matte white
KM12	КОНЕКТОР ЗА ТВ ПРЕХОДЕН SOCKET TV TROUGHPASS	10dB	1M	<input checked="" type="checkbox"/> SB сензорен бутон черен soft touch black
:	:	:	:	<input type="checkbox"/> AT антрацит anthracite
:	:	:	:	<input type="checkbox"/> ES сребрист elox silver
:	:	:	:	<input type="checkbox"/> IW слонова кост ivory white

КОНЕКТОР ЗА ТВ ОСНОВЕН 0 dB 1M



- KM10PW
- KM10MW
- KM10SB
- KM10AT
- KM10ES
- KM10IW

- контакт за ТВ базов
 - затихване 0 dB
 - заден конектор – стандарт F
- SOCKET TV BASIC 0dB 1M
- TV basic
 - reduction 0dB
 - back connector – F standard



КОНЕКТОР ЗА ТВ ОСНОВЕН 0 dB 2M

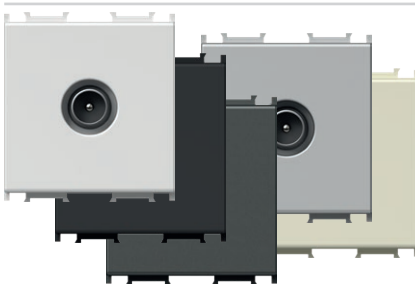

- KM20PW
- KM20MW
- KM20SB
- KM20AT
- KM20ES
- KM20IW

- контакт за ТВ базов
 - затихване 0 dB
 - заден конектор – стандарт F
- SOCKET TV BASIC 0dB 2M
- TV basic
 - reduction 0dB
 - back connector – F standard



КОНЕКТОР ЗА ТВ КРАЕН 1 dB 1M

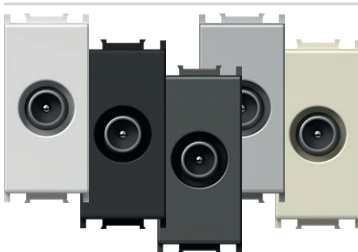

- KM11PW
- KM11MW
- KM11SB
- KM11AT
- KM11ES
- KM11IW

- контакт за ТВ краен
 - честотен обхват 5÷2400 MHz
 - затихване < 1 dB
 - в съответствие с EN 50083-1
 - винтови контакти
- SOCKET TV END-LINE 1dB 1M
- TV end-line
 - frequency range 5÷2400 MHz
 - reduction < 1 dB
 - in accordance with EN 50083-1
 - screw contacts

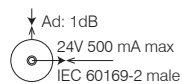

КОНЕКТОР ЗА ТВ ПРЕХОДЕН 10 dB 1M



- KM12PW
- KM12MW
- KM12SB
- KM12AT
- KM12ES
- KM12IW

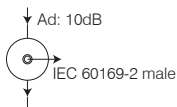

- преходник за ТВ сигнал
- честотен обхват 5÷2400 MHz
- затихване < 10 dB
- в съответствие с EN 50083-1
- винтови контакти

SOCKET TV TROUGHPASS 10dB 1M

- TV troughpass
- frequency range 5÷2400 MHz
- reduction < 10 dB
- in accordance with EN 50083-1
- screw contacts



КОНЕКТОР ЗА САТЕЛИТНА ТВ БАЗОВ 0 dB 1M



- KM15PW
- KM15MW
- KM15SB
- KM15AT
- KM15ES
- KM15IW

- контакт за сателитна ТВ базов
- затихване 0 dB
- заден конектор – стандарт F

SOCKET SAT BASIC 0dB 1M

- SAT basic
- reduction 0dB
- back connector – F standard



КОНЕКТОР ЗА САТЕЛИТНА ТВ БАЗОВ 0 dB 2M

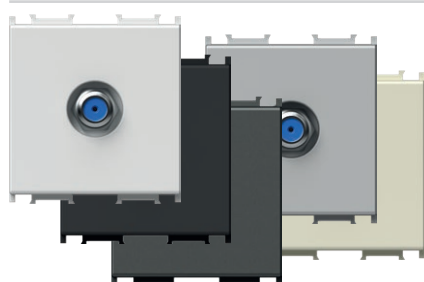

- KM24PW
- KM24MW
- KM24SB
- KM24AT
- KM24ES
- KM24IW

- контакт за сателитна ТВ базов
- затихване 0 dB
- заден конектор – стандарт F

SOCKET SAT BASIC 0dB 2M

- SAT basic
- reduction 0dB
- back connector – F standard



КОНЕКТОР ЗА САТЕЛИТНА ТВ КРАЕН 1 dB 1M

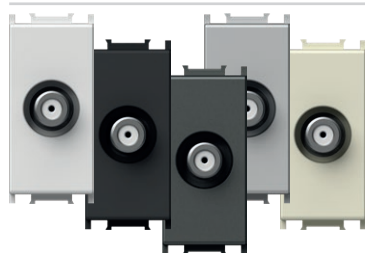

- KM16PW
- KM16MW
- KM16SB
- KM16AT
- KM16ES
- KM16IW

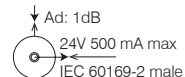

- конектор за сателитна ТВ краен
- честотен обхват 5÷2400 MHz
- затихване 1 dB
- в съответствие с EN 50083-1
- винтови контакти

SOCKET SAT END-LINE 1dB 1M

- SAT end-line
- frequency range 5÷2400 MHz
- reduction < 1dB
- in accordance with EN 50083-1
- screw contacts



КОНЕКТОР ЗА РАДИО ОСНОВЕН 0 dB 1M



- KM19PW
- KM19MW
- KM19SB
- KM19AT
- KM19ES
- KM19IW

- контакт за радио базов
 - затихване 0 dB
 - заден конектор – стандарт F
SOCKET R BASIC 0dB 1M
 - R basic
 - reduction 0dB
 - back connector – F standard



КОНЕКТОР ЗА РАДИО ОСНОВЕН 0 dB 2M

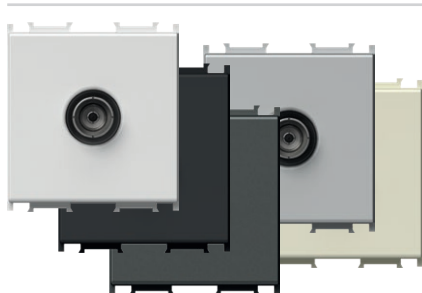

- KM29PW
- KM29MW
- KM29SB
- KM29AT
- KM29ES
- KM29IW

- контакт за радио базов
 - затихване 0 dB
 - заден конектор – стандарт F
SOCKET R BASIC 0dB 2M
 - R basic
 - reduction 0dB
 - back connector – F standard



КОНЕКТОР ЗА САТЕЛИТНА ТВ КРАЕН 1 dB 1M



- KM17PW
- KM17MW
- KM17SB
- KM17AT
- KM17ES
- KM17IW

- контакт за сателитна ТВ краен
 - честотен обхват 5÷2400 MHz
 - затихване 1 dB
 - в съответствие с EN 50083-1
 - винтови контакти

SOCKET SAT-TV END-LINE 1dB 1M
 - SAT-TV end-line
 - frequency range 5÷2400 MHz
 - reduction < 1dB
 - in accordance with EN 50083-1
 - screw contacts

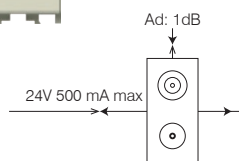

ПРИМЕРИ ЗА ОСНОВНО СВЪРЗВАНЕ
BASIC CONNECTION SAMPLES

индивидуално свързване
stand alone connection

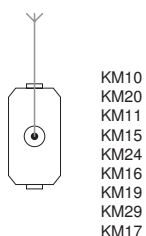

свързване тип звезда
star connection

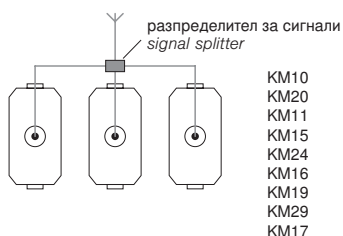

преходно свързване
throughpass connection

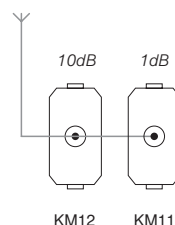

- KM22PW
- KM22MW
- KM22SB
- KM22AT
- KM22ES
- KM22IW

КОНТАКТ ЗА АУДИОСИГНАЛИ 2xRCA 1M

- за аудиосигнали, с конектори 2x RCA
- свързване на кабела от задната страна чрез запояване

SOCKET AUDIO 2xRCA 1M

- audio 2x RCA
- soldering connection of cable at the back side



- KM23PW
- KM23MW
- KM23SB
- KM23AT
- KM23ES
- KM23IW

КОНЕКТОР ЗА ВИСОКОГОВОРТЕЛИ 1M

- за аудиосигнали, 2x Ø4 mm
- за проводник за високоговорители, с щепсел тип банан Ø4 mm или плоски конектори
- свързване на кабела от задната страна чрез запояване

SOCKET AUDIO LOUDSPEAKERS 1M

- audio 2x Ø4mm
- to accommodate speaker wire, banana plug Ø4mm or spades
- soldering connection of cable at the back side



- KM26PW
- KM26MW
- KM26SB
- KM26AT
- KM26ES
- KM26IW

КОНЕКТОР ЗА ВИСОКОГОВОРТЕЛИ 2M

- за аудиосигнали, 2x Ø4 mm
- за проводник за високоговорители, с щепсел тип банан Ø4 mm или плоски конектори
- свързване на кабела от задната страна чрез запояване

SOCKET AUDIO LOUDSPEAKERS 2M

- audio 2x Ø4mm
- to accommodate speaker wire, banana plug Ø4mm or spades
- soldering connection of cable at the back side



1M = 22,5 x 45
2M = 45 x 45

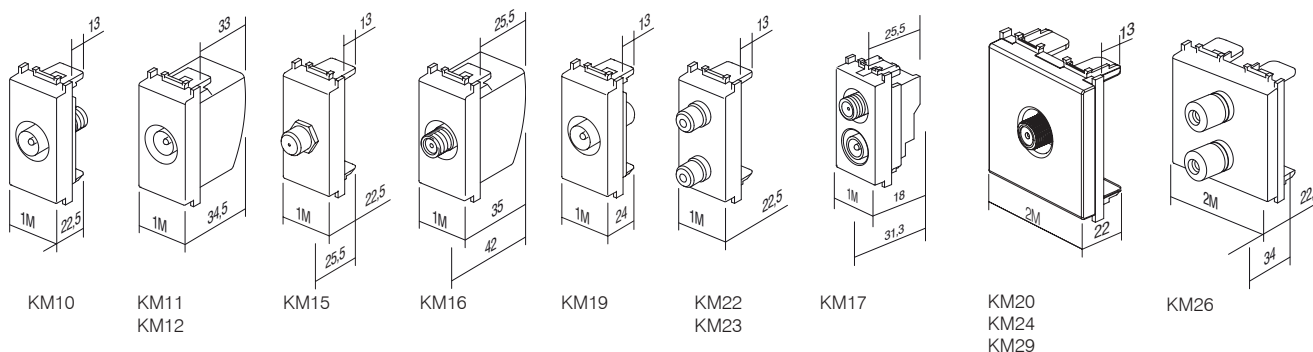

КОНЕКТОР ЗА ТЕЛЕФОН LT RJ11 6/4 1M



- KM30PW
- KM30MW
- KM30SB
- KM30AT
- KM30ES
- KM30IW

- телефонен LT винтов
- RJ11 6/4
- в съответствие с IEC 60603-7
- винтови контакти

SOCKET TEL LT RJ11 6/4 1M

- TEL LT screw
- RJ11 6/4
- in accordance with IEC 60603-7
- screw contacts



КОНЕКТОР TEL BT SEC 6/6 1M

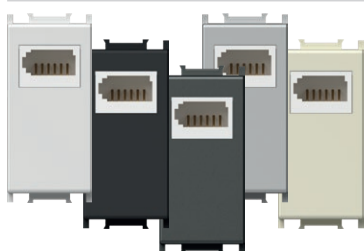

- KM31PW
- KM31MW
- KM31SB
- KM31AT
- KM31ES
- KM31IW

- ТЕЛЕФОНЕН BT британски стандарт
- SEC вторичен 6/6
- в съответствие с BS 6312
- винтови контакти

SOCKET TEL BT SEC 6/6 1M

- TEL BT British standard
- SEC secondary 6/6
- in accordance with BS 6312
- screw contacts



КОНЕКТОР ЗА ТЕЛЕФОН KS RJ11 6/4 1M

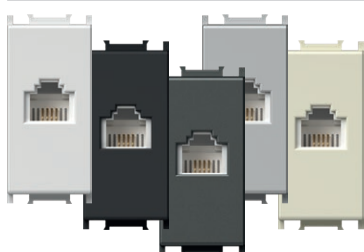

- KM36PW
- KM36MW
- KM36SB
- KM36AT
- KM36ES
- KM36IW

- KS модулен стандарт за закрепване
- RJ11 6/4
- в съответствие с IEC 60603-7

SOCKET TEL KS RJ11 6/4 1M

- KS keystone fixing standard
- RJ11 6/4
- in accordance with IEC 60603-7

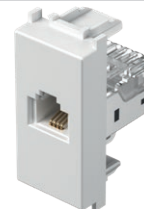

КОНЕКТОР CAT5e KS RJ45 8/8 1M

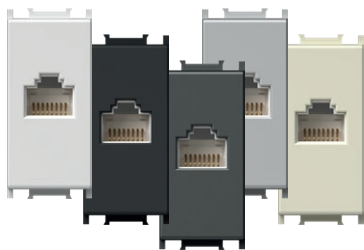

- KM37PW
- KM37MW
- KM37SB
- KM37AT
- KM37ES
- KM37IW

- KS модулен стандарт за закрепване
- CAT5e, RJ45 8/8
- в съответствие с IEC 60603-7

SOCKET CAT5e KS RJ45 8/8 1M

- KS keystone fixing standard
- CAT5e, RJ45 8/8
- in accordance with IEC 60603-7

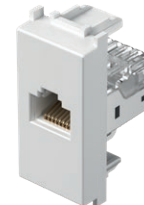

АДАПТЕР KS 1M

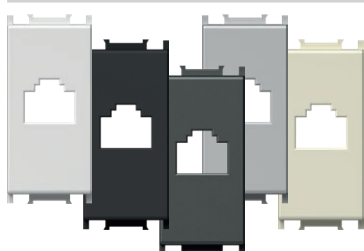

- KM35PW
- KM35MW
- KM35SB
- KM35AT
- KM35ES
- KM35IW

- KS модулен стандарт за закрепване
- AMP, Avaya, Brandrex, FMT, Mfico, Tyco, ...
- комуникационният модул не е включен в доставката

ADAPTER KS 1M

- KS keystone fixing standard
- AMP, Avaya, Brandrex, FMT, Mfico, Tyco, ...
- communication module not included



АДАПТЕР СЪС ЗАЩИТА ПРОТИВ ПРАХ 1M

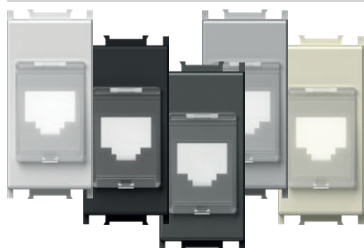

- KM38PW
- KM38MW
- KM38SB
- KM38AT
- KM38ES
- KM38IW

- KS модулен стандарт за закрепване със защита против прах
- AMP, Avaya, Brandrex, FMT, Mfico, Tyco, ...
- комуникационният модул не е включен в доставката

ADAPTER KS WITH DUST PROTECTION 1M

- KS keystone fixing standard with dust protection
- AMP, Avaya, Brandrex, FMT, Mfico, Tyco, ...
- communication module not included



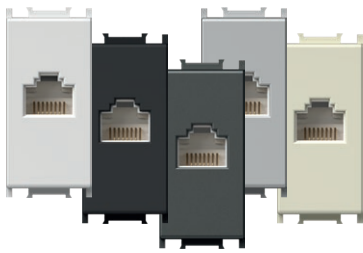

- KM39PW
- KM39MW
- KM39SB
- KM39AT
- KM39ES
- KM39IW

КОНЕКТОР CAT6 SCH KS RJ45 8/8 1M

- KS модулен стандарт за закрепване
- CAT6 UTP без нужда от инструменти, RJ45 8/8
- в съответствие с ISO/IEC 11801

SOCKET CAT6 SCH KS RJ45 8/8 1M

- KS keystone fixing standard
- CAT6 UTP toolless, RJ45 8/8
- in accordance with ISO/IEC 11801

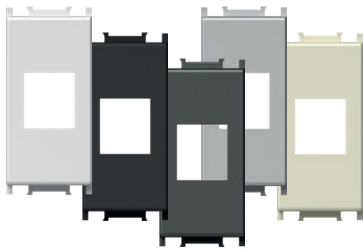
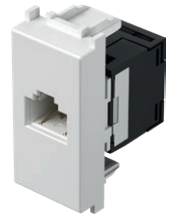

- KM50PW
- KM50MW
- KM50SB
- KM50AT
- KM50ES
- KM50IW

УНИВЕРСАЛЕН АДАПТЕР KS 1M

- KS модулен стандарт за закрепване
- подходящ за HDMI, USB
- комуникационният модул не е включен в доставката

ADAPTER KS UNIVERSAL 1M

- KS keystone fixing standard
- suitable for HDMI, USB
- communication module not included



- KM40PW
- KM40MW
- KM40SB
- KM40AT
- KM40ES
- KM40IW

АДАПТЕР PD 1M

- стандарт за закрепване PD Panduit Mini-COM
- комуникационният модул не е включен в доставката

ADAPTER PD 1M

- PD Panduit Mini-COM fixing standard
- communication module not included



- KM43PW
- KM43MW
- KM43SB
- KM43AT
- KM43ES
- KM43IW

АДАПТЕР PD СЪС ЗАЩИТА ПРОТИВ ПРАХ 1M

- стандарт за закрепване PD Panduit Mini-COM със защита против прах
- комуникационният модул не е включен в доставката

ADAPTER PD WITH DUST PROTECTION 1M

- PD Panduit Mini-COM fixing standard with dust protection
- communication module not included



АДАПТЕР R&M 1M

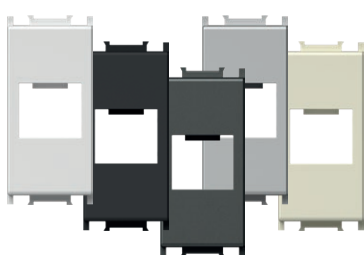

- KM46PW
- KM46MW
- KM46SB
- KM46AT
- KM46ES
- KM46IW

- стандарт за закрепване R&M
- комуникационният модул не е включен в доставката

ADAPTER R&M 1M

- R&M fixing standard
- communication module not included



АДАПТЕР R&M CAT6A 1M

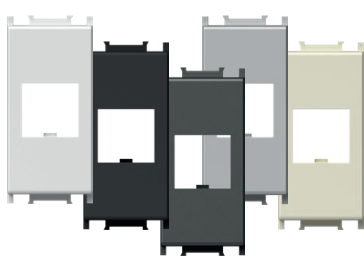

- KM52PW
- KM52MW
- KM52SB
- KM52AT
- KM52ES
- KM52IW

- закрепване R&M за CAT6A
- комуникационният модул не е включен в доставката

ADAPTER R&M CAT6A 1M

- R&M fixing for CAT6A
- communication module not included



АДАПТЕР R&M СЪС ЗАЩИТА ПРОТИВ ПРАХ 1M



- KM47PW
- KM47MW
- KM47SB
- KM47AT
- KM47ES
- KM47IW

- стандарт за закрепване R&M със защита против прах
- комуникационният модул не е включен в доставката

ADAPTER R&M WITH DUST PROTECTION 1M

- R&M fixing standard with dust protection
- communication module not included



АДАПТЕР R&M CAT6A СЪС ЗАЩИТА ПРОТИВ ПРАХ 1M



- KM53PW
- KM53MW
- KM53SB
- KM53AT
- KM53ES
- KM53IW

- закрепване R&M за CAT6A със защита против прах
- комуникационният модул не е включен в доставката

ADAPTER R&M CAT6A WITH DUST PROTECTION 1M

- R&M fixing for CAT6A with dust protection
- communication module not included



АДАПТЕР LK 1M

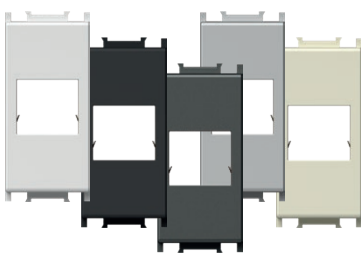

- KM45PW
- KM45MW
- KM45SB
- KM45AT
- KM45ES
- KM45IW

- стандарт за закрепване LK LeoniKerpen eLine/BKS NewLine
- комуникационният модул не е включен в доставката

ADAPTER LK 1M

- LK LeoniKerpen eLine / BKS NewLine fixing standard
- communication module not included



АДАПТЕР NEXANS/SCHRACK 2M

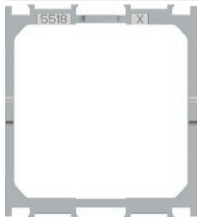

KA26

- адаптер за закрепване за Nexans LANmark и LANmark за Schrack размер 45x45 mm
- модул Schrack 45x45 mm
- подходящ за Schrack тип HSEMD02W2F
- комуникационният модул не е включен в доставката

ADAPTER NEXANS/SCHRACK 2M

- fixing adapter for Nexans LANmark and Schrack module 45x45mm
- suitable for Nexans type N423.540N
- suitable for Schrack type HSEMD02W2F
- communication module not included

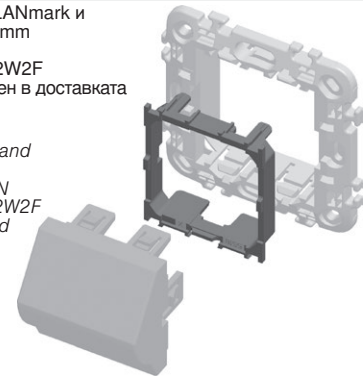

АДАПТЕР AT&T SYSTIMAX СЪС ЗАЩИТА ПРОТИВ ПРАХ 1M



- KM48PW
- KM48MW
- KM48SB
- KM48AT
- KM48ES
- KM48IW

- стандарт за закрепване AT&T Systimax със защита против прах
- комуникационният модул не е включен в доставката

ADAPTER AT&T SYSTIMAX WITH DUST PROTECTION 1M

- AT&T Systimax fixing standard with dust protection
- communication module not included



КОНЕКТОР USB ТИП А 1M



- KM51PW
- KM51MW
- KM51SB
- KM51AT
- KM51ES
- KM51IW

- конектор тип А за USB 2.0
- винтови контакти, стъпка 5 mm, 1,5 mm², 1x2P + 1x3P
- свързване:
 - Щифт 1 – VCC (+5V, червен проводник)
 - Щифт 2 – Данни – (бял проводник)
 - Щифт 3 – Данни + (зелен проводник)
 - Щифт 4 – МАСА – (черен проводник)
 - S – екранировка
- в съответствие с Директива 2011/95/EC (RoHS2)

SOCKET USB TYPE A 1M

- USB 2.0 socket type A
- screw contacts, raster 5 mm, 1,5 mm², 1x2P + 1x3P
- wiring:
 - PIN 1 – VCC (+5V, red wire)
 - PIN 2 – Data - (white wire)
 - PIN 3 – Data + (green wire)
 - PIN 4 – GND - ground (black wire)
 - S – shield
- in accordance with directive 2011/95/EU (RoHS2)



1M = 22,5 x 45
2M = 45 x 45

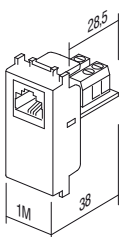

KM30

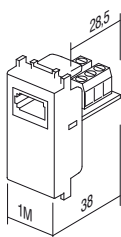

KM31

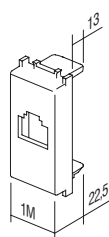
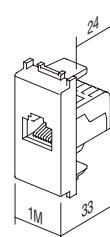
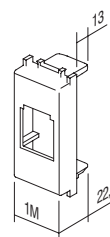
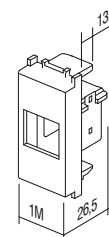
KM35
KM38
KM48KM36
KM37
KM39KM40
KM43

KM45

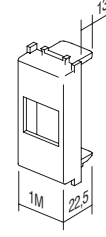
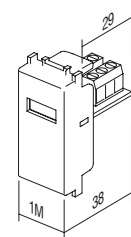
KM46
KM47
KM50
KM52
KM53

KM51

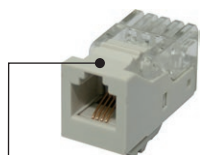

КА10

тип <i>type</i>	описание <i>description</i>	технически данни <i>technical data</i>
КА10	КОНЕКТОР KS CAT3 <i>CONNECTOR KS CAT3</i>	RJ11 6/4
КА11	КОНЕКТОР KS CAT5e <i>CONNECTOR KS CAT5e</i>	RJ45 8/8
КА12	КОНЕКТОР KS CAT5eS <i>CONNECTOR KS CAT5eS</i>	RJ45 8/8
⋮	⋮	⋮



КА10

КОНЕКТОР KS CAT3 RJ11 6/4

- KS модул стандарт за закрепване
- CAT3, RJ11 6/4
- в съответствие с IEC 60603-7

CONNECTOR KS CAT3 RJ11 6/4

- KS keystone fixing standard
- CAT3, RJ11 6/4
- in accordance with IEC 60603-7



КА11

КОНЕКТОР KS CAT5e RJ45 8/8

- KS модул стандарт за закрепване
- CAT5e, RJ45 8/8
- в съответствие с IEC 60603-7

CONNECTOR KS CAT5e RJ45 8/8

- KS keystone fixing standard
- CAT5e, RJ45 8/8
- in accordance with IEC 60603-7



КА12

КОНЕКТОР KS CAT5eS RJ45 8/8

- KS модул стандарт за закрепване
- CAT5eS, RJ45 8/8
- в съответствие с IEC 60603-7

CONNECTOR KS CAT5eS RJ45 8/8

- KS keystone fixing standard
- CAT5eS, RJ45 8/8
- in accordance with IEC 60603-7



KA15

КОНЕКТОР KS CAT6 SCH RJ45 8/8

- KS модулен стандарт за закрепване
- CAT6 UTP без нужда от инструменти, RJ45 8/8
- в съответствие с ISO/IEC 11801

CONNECTOR KS CAT6 SCH RJ45 8/8

- KS keystone fixing standard
- CAT6 UTP toolless, RJ45 8/8
- in accordance with ISO/IEC 11801



KA16

КОНЕКТОР KS CAT6S SCH RJ45 8/8

- KS модулен стандарт за закрепване
- CAT6S STP без нужда от инструменти, RJ45 8/8
- в съответствие с ISO/IEC 11801

CONNECTOR KS CAT6S SCH RJ45 8/8

- KS keystone fixing standard
- CAT6S STP toolless, RJ45 8/8
- in accordance with ISO/IEC 11801

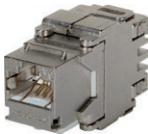

KA17

КОНЕКТОР KS CAT6a SCH RJ45 8/8

- KS модулен стандарт за закрепване
- CAT6a STP без нужда от инструменти, RJ45 8/8
- в съответствие с ISO/IEC 11801

CONNECTOR KS CAT6a SCH RJ45 8/8

- KS keystone fixing standard
- CAT6a STP toolless, RJ45 8/8
- in accordance with ISO/IEC 11801



KA18

КОНЕКТОР SLIM KS CAT6S SCH RJ45 8/8

- KS модулен стандарт за закрепване
- компактно изпълнение
- CAT6S STP без нужда от инструменти, RJ45 8/8
- в съответствие с ISO/IEC 11801
- също така е подходящ за двоен адаптор KE46

CONNECTOR SLIM KS CAT6S SCH RJ45 8/8

- KS keystone fixing standard
- slim style
- CAT6S STP toolless, RJ45 8/8
- in accordance with ISO/IEC 11801
- suitable also for KE46 double adapter



□ KA27PW
 ■ KA27BK

КОНЕКТОР KS HDMI

- KS модулен стандарт за закрепване
- само в комбинация с адаптер KM50
- HDMI/HDMI

CONNECTOR KS HDMI

- KS keystone fixing standard
- only in combination with adapter KM50
- HDMI/HDMI



KA28

КАБЕЛ KS HDMI

- KS модулен стандарт за закрепване
- само в комбинация с адаптер KM50
- HDMI/HDMI

CABLE KS HDMI

- KS keystone fixing standard
- only in combination with adapter KM50
- HDMI/HDMI



EM33



PW



тип type	описание description	технически данни technical data	размер size	цвет colour
EM12	ДИМЕР, ВЪРТЯЩ ТИП/ДВУПОСОЧЕН, RL 300W АКТИВЕН/ИНДУКТИВЕН ТОВАР DIMMER ROTATIVE 2WAY		1M	<input type="checkbox"/> PW снежнобял цвят polar white <input type="checkbox"/> MW Бял матов цвят matte white <input type="checkbox"/> SB сензорен бутон, черен soft touch black <input type="checkbox"/> AT антрацит anthracite <input type="checkbox"/> ES сребрист elox silver <input type="checkbox"/> IW слонова кост ivory white
EM23	ДИМЕР, ВГРАДЕН, ЗА АКТИВЕН ТОВАР DIMMER INBOX	R (250 W), (RC,RL 200VA)	/	<input type="checkbox"/> BL син цвят blue <input type="checkbox"/> RD червен red <input type="checkbox"/> GR зелен green <input type="checkbox"/> OR оранжев orange <input type="checkbox"/> RG червен/зелен red/green
.
.

ДИМЕР, ВЪРТЯЩ ТИП/ДВУПОСОЧЕН, АКТИВЕН/ИНДУКТИВЕН ТОВАР 300 W 1M



- EM12PW
- EM12MW
- EM12SB
- EM12AT
- EM12ES
- EM12IW



- управление чрез завъртане, с двупосочен ключ
- активен/индуктивен товар, 40 W – 300 W
- захранващо напрежение 230 V~ 50 Hz
- възможна е комбинация с двупосочен ключ
- допуска се инсталиране на няколко устройства заедно в една конзола само ако общият им максимален товар не превишава максималната мощност на един димер
- една верига позволява използване само на един димер
- без вграден предпазител – трябва да се използва външен предпазител
- в съответствие с EN 60669-1
- винтови контакти – 1,5-2,5 mm²
- интегрирана светодиодна индикация за нивото на димиране



DIMMER ROTATIVE/2WAY RL 300W 1M

- rotation control with 2-way switch
- load RL, 40W - 300W
- supply voltage 230V~ 50Hz
- 2-way switch combination is possible
- installing several devices together in one box is only permitted if their total maximum load does not exceed the maximum power of a single dimmer
- one circuit allows the use of only one dimmer
- no built-in fuse – external fuse must be used
- in accordance with EN 60669-1
- screw contacts - 1.5-2.5mm²
- integrated LED indication of dimming level

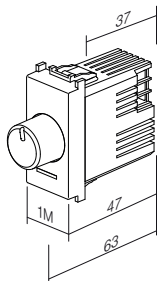

ДИМЕР, ВЪРТЯЩ ТИП/ДВУПОСОЧЕН, ЗА СВЕТОДИОДНО ОСВЕТЛЕНИЕ 60 W 1M



- EM13PW
- EM13MW
- EM13SB
- EM13AT
- EM13ES
- EM13IW

- управление чрез завъртане, с двупосочен ключ
- товар: светодиодно осветление, 0 – 60 W (макс. 6 димируеми светодиодни лампи)

- GLS, 0 – 60 W
- захранващо напрежение 230 V~ 50 Hz
- възможна е комбинация с двупосочен ключ
- допускат се инсталиране на няколко устройства заедно в една конзола само ако общият им максимален товар не превишава максималната мощност на един димер
- една верига позволява използване само на един димер
- без вграден предпазител – трябва да се използва външен предпазител
- в съответствие с IEC60669-2-1
- винтови контакти – 1,5-2,5 mm²

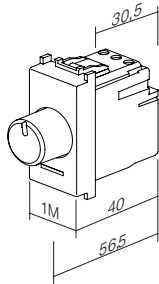

DIMMER ROTATIVE/2WAY LED 60W 1M

- rotation control with 2-way switch
- loads: LED, 0 – 60W (max. 6 dimmable LED lamps)
GLS, 0 – 60W

- supply voltage 230V~ 50Hz
- 2-way switch combination is possible
- installing several devices together in one box is only permitted if their total maximum load does not exceed the maximum power of a single dimmer
- one circuit allows the use of only one dimmer
- no built-in fuse – external fuse must be used
- in accordance with IEC60669-2-1
- screw contacts - 1.5-2.5mm²

ДИМЕР, ВЪРТЯЩ ТИП/ДВУПОСОЧЕН, ЗА СВЕТОДИОДНО ОСВЕТЛЕНИЕ 180W 1M



- EM14PW
- EM14MW
- EM14SB
- EM14AT
- EM14ES
- EM14IW

- управление чрез завъртане, с двупосочен ключ
- товар: светодиодно осветление, 0 – 180 W (макс. 20 димируеми светодиодни лампи)

- GLS, 0 – 180 W
- захранващо напрежение 230 V~ 50 Hz
- възможна е комбинация с двупосочен ключ
- допускат се инсталиране на няколко устройства заедно в една конзола само ако общият им максимален товар не превишава максималната мощност на един димер
- една верига позволява използване само на един димер
- без вграден предпазител – трябва да се използва външен предпазител
- в съответствие с IEC60669-2-1
- винтови контакти – 1,5-2,5 mm²

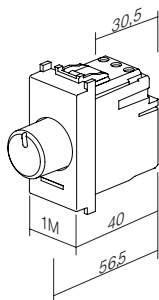
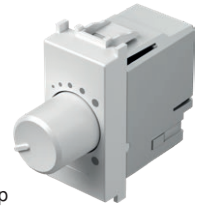

DIMMER ROTATIVE/2WAY LED 180W 1M

- rotation control with 2-way switch
- loads:
LED, 0 – 180W (max. 20 dimmable LED lamps)
GLS, 0 – 180W

- supply voltage 230V~ 50Hz
- 2-way switch combination is possible
- installing several devices together in one box is only permitted if their total maximum load does not exceed the maximum power of a single dimmer
- one circuit allows the use of only one dimmer
- no built-in fuse – external fuse must be used
- in accordance with IEC60669-2-1
- screw contacts - 1.5-2.5mm²

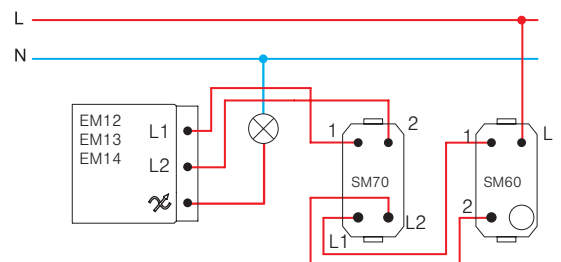
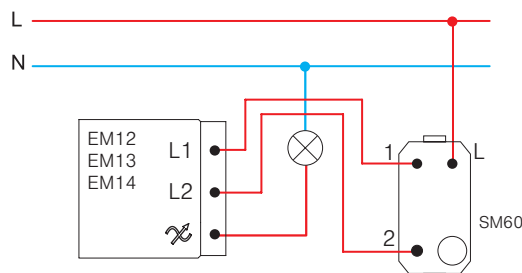
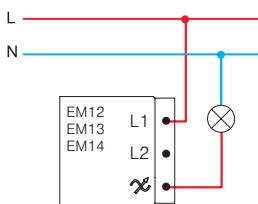

ДИМЕР, ВЪРТАЩ ТИП, R 250W 1M



- EM15PW
- EM15MW
- EM15SB
- EM15AT
- EM15ES
- EM15IW



- управление чрез завъртане, без ключ
- активен товар, 40 W – 250 W
- захранващо напрежение 230 V~ 50 Hz
- не е възможна комбинация с двупосочен ключ
- не се допуска комбинация с допълнителни димери
- в съответствие с EN 60669-1
- винтови контакти 1,5 - 2,5 mm²
- светодиодна индикация

DIMMER ROTATIVE R 250W 1M

- rotation control without switch
- load R, 40W - 250W
- supply voltage 230V~ 50Hz
- 2-way switch combination is not possible
- more dimmers combination is not allowed
- in accordance with EN 60669-1
- screw contacts 1.5-2.5mm²
- LED indication

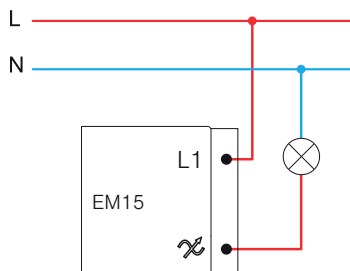
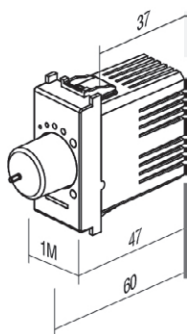

ДИМЕР, ВГРАДЕН, ЗА АКТИВЕН ТОВАР (250 W),
(АКТИВЕН/КАПАЦИТИВЕН, АКТИВЕН/ИНДУКТИВЕН ТОВАР 200 VA)



EM23



- вграден, управлява се от външен бутон
- активен/индуктивен/капацитивен товар 15-250 W или 15-200 VA
- захранващо напрежение 230 V~ 50 Hz
- възможни са комбинации от няколко бутона
- не се допуска комбинация с допълнителни димери
- памет за интензивността на осветлението
- функция за плавно стартиране/спиране
- »leading edge«
- в съответствие с EN60669, EN60950, EN 61000, ETSI EN 300 220-1, ETSI EN 300 220-2
- винтови контакти за проводници 2,5 mm²

DIMMER INBOX R (250 W), (RC, RL 200 VA)

- inbox, controlled by external push button
- load RLC 15-250W or 15-200 VA
- supply voltage 230V~ 50Hz
- several push-buttons combinations are possible
- more dimmers combination is not allowed
- light intensity memory
- soft start/stop function
- »leading edge«
- in accordance with EN60669, EN60950, EN 61000, ETSI EN 300 220-1, ETSI EN 300 220-2
- screw contacts to wires 2,5 mm²

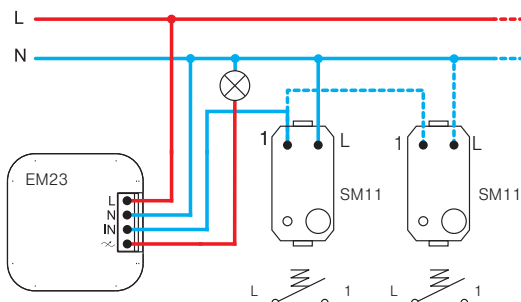
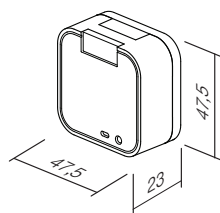



- EM16PW
- EM16MW
- EM16SB
- EM16AT
- EM16ES
- EM16IW



1 – 10 V ДИМЕР, ВЪРТЯЩ ТИП, ДВУПОСОЧЕН

- номинално работно напрежение: 10 V DC
- минимално работно напрежение: 0,7 V DC
- диапазон на димиране: 0,7% – 100% (в зависимост от драйвера и товара)
- минимален понорен ток: 0,1 mA
- максимален понорен ток: 120 mA
- максимална консумация: 0,35 W
- защита срещу свръхнапрежение: 15,8 V DC до 250 mA (несменяема)
- най-голям пулсов ток: 3 A DC
- вид товар: 0 – 10 V, 1 – 10 V и PWM
- тип на ключа: механичен: натисни включи/изключи
- проводник на нустралата: не е необходим
- номинално работно напрежение: 100 – 240 V AC, 50 – 60 Hz
- максимален моментен ток: 10 A
- максимален работен ток: 8 A
- максимално натоварване (при 230 V~): 1800 VA (1800 x pf = max. W)
- изоляционно съпротивление: > 100 MΩ при 250 V~
- защита срещу свръхнапрежение и късо съединение: 10 A, 350 V~ (несменяема)
- ъгъл на ротация: 270° ± 5°
- работна температура: -5 до 40° C
- температура на съхранение: -30 до 80° C
- максимална температура на рамката: 65° C
- максимална влажност: 90% (без кондензация)
- EMC и имунност: CISPR 15(2008), IEC 61547
- LVD: IEC 60669-1:2017, IEC 60669-2-1:2015

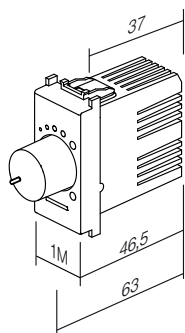

1-10 V DIMMER ROTARY TOGGLE

- nominal operating voltage: 10 VDC
- minimum operating voltage: 0.7 VDC
- dimming range: 0.7% – 100% (depending on power supply and loads)
- minimum sink current: 0.1 mA
- maximum sink current: 120 mA
- maximum consumption: 0.35 W
- surge protection: 15.8 VDC up to 250 mA (not replaceable)
- maximum pulse current: 3 ADC
- load types: 0-10 V, 1-10 V and PWM
- switch type: mechanical: push on/off
- zero cable: not required
- nominal operating voltage: 100-240 V~, 50-60 Hz
- maximum instantaneous current: 10 A
- maximum operating current: 8 A
- maximum load (at 230 V~): 1800 VA (1800 x pf = max. W)
- isolation resistance: > 100 MΩ at 250 V~
- surge protection and Short-circuit protection: 10 A, 350 V~ (not replaceable)
- rotation angle: 270° ± 5°
- operating temperature: -5 to 40°C
- storing temperature: -30 to 80°C
- maximum housing temperature: 65°C
- maximum humidity: 90% (no condensation)
- EMC & immunity: CISPR 15(2008), IEC 61547
- LVD: IEC 60669-1:2017, IEC 60669-2-1:2015

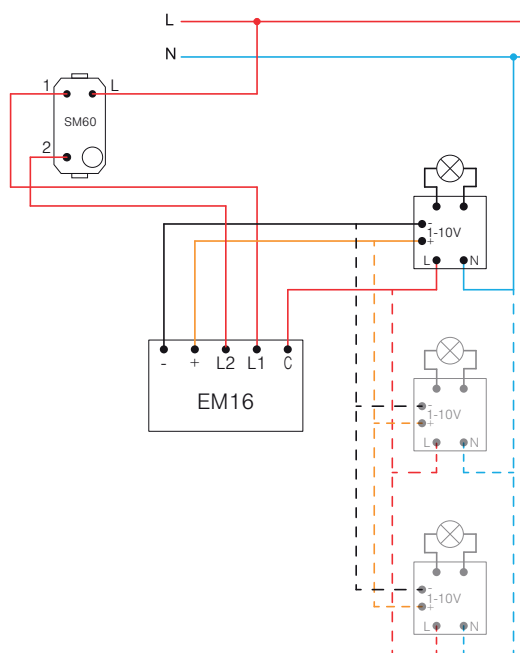
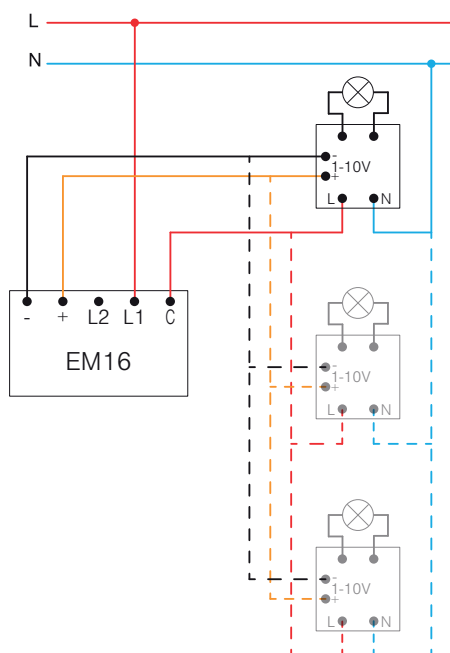

УПРАВЛЯВАЩ модул MZC за EM18

EM17

- свържете MZC, съгласно схемата за свързване.
- възможно свързване с няколко бутона.
- монтаж само на едно устройство в една конзола
- само за вътрешно ползване
- захранване: 230 V~ 50Hz
- максимално съпротивление на жиците: 50 kΩ
- максимален ток през част MZC: 10 mA
- брой димери на MZC: 1-4
- максимален брой MZC в мрежата: ограничено до предпазител в движението на тока- температура при функциониране: -5 °C до 45 °C
- температура на складиране: -30 °C до 80 °C
- максимална влажност: 90% (без кондензиране)
- размери на корпуса: 36 x 36 x 12 mm.

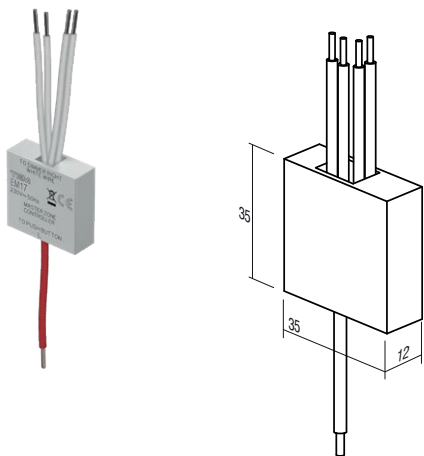

MZC CONTROL Module for EM18

- Connect the MZC according to the wiring diagram.
- Possible wiring with several push buttons.
- Only one device installation per mounting box.
- For indoor use only.
- Power supply: 230V~ 50Hz
- Max. cable resistance: 50kΩ
- Max. current per MZC unit: 10mA
- Number of dimmers on MZC: 1-4
- Max. number of MZC in the wiring: limited to the fuse in the circuit
- Operating temperature: -5°C to 45°C
- Storage temperature: -30°C to 80°C
- Max. humidity: 90% (no condensation)
- Casing dimensions: 36x36x12 mm

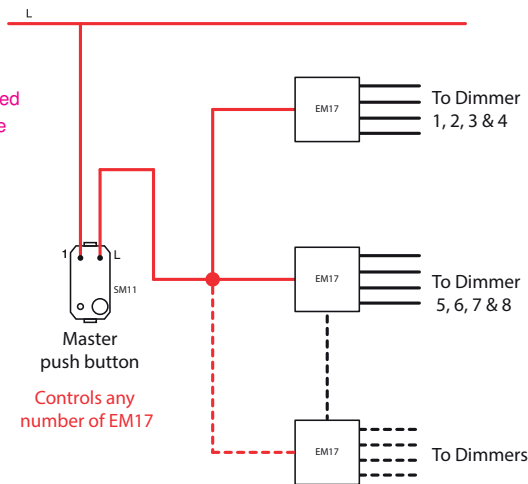
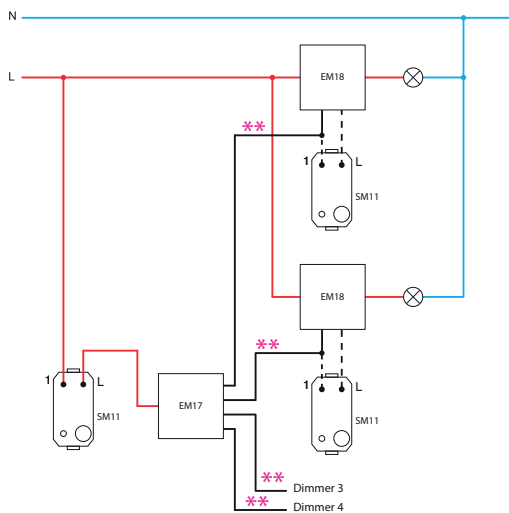

ДИМЕРНО УСТРОЙСТВО ЗА СВЕТОДИОДИ 250W

EM18

- вградена кутия, управлява се външно чрез бутон
- за индуктивен и капацитивен товар
- захранващо напрежение 230 V~ 50 Hz
- възможни са няколко комбинации с бутони
- функция за запаметяване на последната настройка, освен при прекъсване на захранването
- функция за плавен старт/стоп
- контрол на минималния интензитет
- само един димер за стенна кутия
- само за употреба на закрито
- в съответствие с EN 60669-1 и EN 60669-2-1



DIMMER INBOX LED 250W

- inbox, controlled by external push button
- for leading or trailing edge
- supply voltage 230V~ 50Hz
- several push-buttons combinations is possible
- memory function of the last setting, except in the case of a power failure
- soft start / stop function
- minimum intensity control
- only one dimmer per wall box
- only for indoor usage
- in accordance with EN 60669-1 and EN 60669-2-1

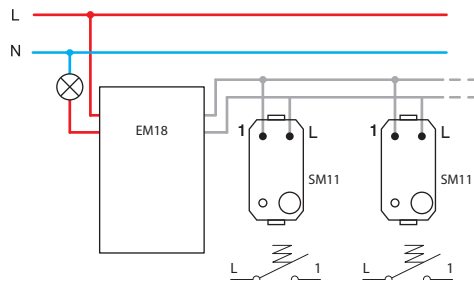
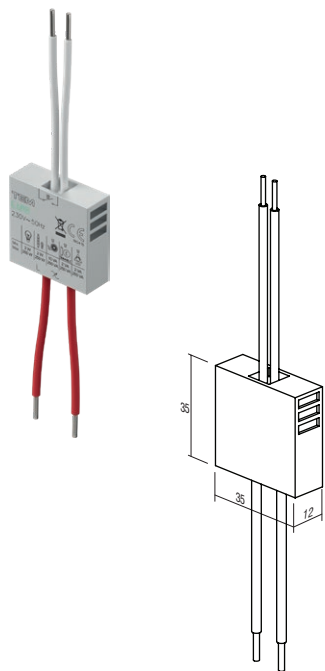

ДИМЕРНО УСТРОЙСТВО ЗА СВЕТОДИОДИ, ПОСТОЯНЕН ТОК 96 W

EM19

- вградена кутия, управлява се външно чрез бутон
- за употреба със светодиодни драйвери с постоянно напрежение и някои светодиодни драйвери с постоянен ток, 9 – 48 V DC, макс. 96 W (подходящо и за светодиодни ленти)
- не е подходящо за употреба при индуктивен товар
- възможни са комбинации от няколко бутона и няколко димера
- функция за запаметяване на последната настройка, освен при прекъсване на захранването
- функция за плавен старт/стоп
- само един димер за стенна кутия
- само за употреба на закрито

DIMMER INBOX DC LED 96W

- inbox, controlled by external push button
- for use with constant voltage LED drivers and some constant current LED drivers, 9-48V DC, max 96W (also for LED strips)
- not for use with inductive loads
- several push-buttons combinations and several dimmers is possible
- memory function of the last setting, except in the case of a power failure
- soft start / stop function
- only one dimmer per wall box
- only for indoor usage

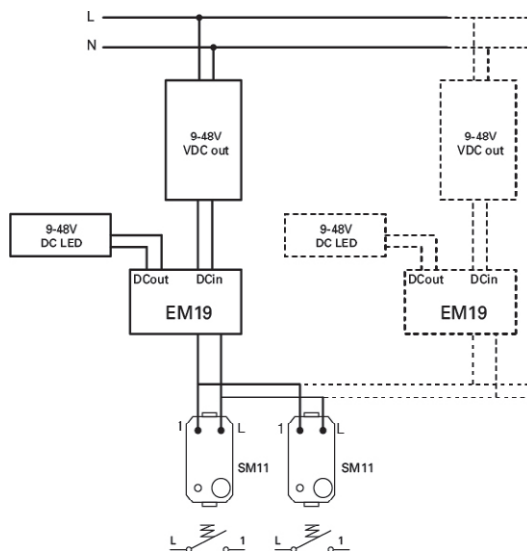
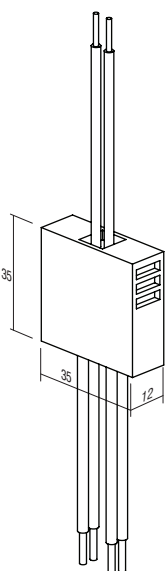

ВНИМАНИЕ!

Ако няколко димера са свързани в една конзола, намалете допустимата обща максимална мощност с 10 % за всеки димер.

ATTENTION!

If more dimmers are connected in one box reduce maximum common power for 10% for each dimmer.

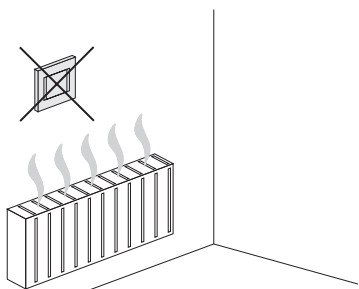

EM15 (40÷250W)

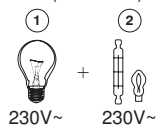

EM12 (40÷300W)

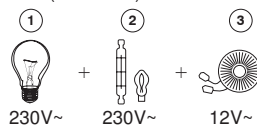

EM13 (0÷60W), EM14 (0÷180W), EM23 (15÷250W, 15÷200VA)

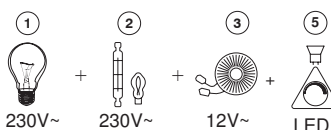

EM18 (2÷250VA)

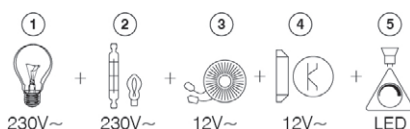

- 1 – лампа с нажеяема жичка / incandescent lamp
- 2 – халогенна лампа / halogen lamp
- 3 – класически трансформатор / classical transformer
- 4 – Димиращ електронен трансформатор / dimmable electronic transformer
- 5 – димируема светодиодна лампа / dimmable LED lamp

КЛЮЧ/УНИВЕРСАЛЕН ДИМЕР ЗА АКТИВЕН/ИНДУКТИВЕН/КАПАЦИТИВЕН ТОВАР 0-300 W 2M



- EM25PW
- EM25MW
- EM25SB
- EM25AT
- EM25ES
- EM25IW



TOUCH EM25 е управляван от микропроцесор електронен димер за осветление. Той служи за ключ и димер за лампи, позволяващи димиране, и за някои видове лампи, не позволяващи димиране. Интегрираният микропроцесор автоматично идентифицира типа на лампата и напаса работния режим. Благодарение на интегрираната функция за запаметяване се запомня нивото на димиране след изключване. Функцията за плавно стартиране/спиране удължава експлоатационния живот на лампите. В бутона е вградена елегантна LED индикация – с възможност за избиране на цвета и настройването на интензитета. Като опция е възможно свързване на максимално 5 допълнителни управляващи устройства EM26 («подчинени устройства») към EM25.

TOUCH EM25 is microprocessor controlled electronic light dimmer. It serves as switch and dimmer for dimmable and some of non-dimmable lamps. Integrated microprocessor automatically identifies the type of lamp and adjusts the operating mode. It remembers the level of dimming after switching off due to integrated memory function. Soft-start function extends the lamp service life. An elegant LED indication is integrated into the button and the option of choosing a colour and intensity level is provided. Optionally one can connect of up to 5 additional control tasters EM26 («slave»).

- универсален електронен димер за включване, изключване и димиране на всички лампи, позволяващи димиране (класически, халогенни, светодиодни, газоразрядни...) и някои видове лампи, не позволяващи димиране
- автоматично определяне на типа на лампата и регулиране на работния режим
- намалена консумация на енергия
- функцията за плавно стартиране/спиране удължава живота на лампите
- управление чрез вградени микроклучета
- съдържа функция за запаметяване – запомня силата на осветлението в момента на изключване
- допълнително може да се свържат до пет (5) устройства за управление EM26
- не е възможно свързване с двупосочен ключ
- вградена защита против късо съединение, прегряване и претоварване
- запазващо напрежение 230 V~ 50 Hz
- Вградена елегантна LED индикация, с възможност за настройване на цвета и интензитета.
- заменя на обикновен ключ е възможно при двупроводно свързване (1)
- заменя на обикновен ключ е възможно при двупроводно свързване (2)
- в съответствие с EN 60669-1 и EN 60669-2-1
- винтови контакти за проводници 1,5 mm² (макс. въртящ момент за притягане 0,4 Nm)

SWITCH / DIMMER UNIVERSAL RLC 0-300W 2M

- universal electronic dimmer for ON/OFF switching and dimming of all dimmable lamps (classical, halogen, LED, CFL, ...) and some non-dimmable lamps
- automatic detection of lamp type and adjustment of operating mode
- reduction of energy consumption
- soft start function extends life of lamps
- controlled by build-in micro switches
- memory function included – memorizes brightness on turn-off
- up to five (5) additional control units EM26 can be connected
- connection with 2-way switch is not possible
- build-in short-circuit, overheating and overload protection
- supply voltage 230V~ 50Hz
- an elegant integrated LED indication with the option of setting colour and intensity.
- replacement of classical switch is possible at two-wire connection⁽¹⁾
- full functionality is achieved at three-wire connection⁽²⁾
- in accordance with EN 60669-1 and EN 60669-2-1
- screw contacts 1.5mm² (max. tightening torque 0.4Nm)

(1) двупроводно свързване
two-wire connection

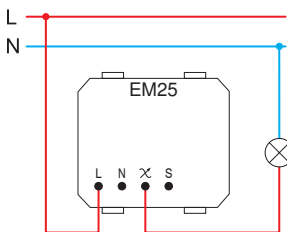

(2) трипроводно свързване
three-wire connection

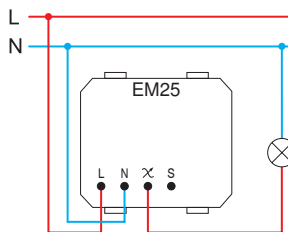

- двупроводното свързване дава възможност за димиране на лампи, позволяващи димиране
- two-wire connection allows dimming of dimmable lamps

- трипроводното свързване дава възможност за димиране на лампи, позволяващи димиране, и на някои видове не позволяващи димиране светодиодни и газоразрядни лампи
- three-wire connection allows dimming of dimmable lamps and some of non-dimmable LED and CFL lamps

	1	2	5	6	7
Min.	40 W	40 W	40 VA	40 VA	40 VA
Max.	300 W	300 W	300 VA	100 VA	100 VA
	(F)	(F)	(F)		

	1	2	4	6	7	8	9
Min.	0 W	0 W	0 VA	0 VA	0 VA	0 VA	0 VA
Max.	300 W	300 W	120 VA	120 VA	120 VA	120 VA	120 VA
	(F)	(F)	(F)			(F)	(F)

- 1 – лампа с нажеваема жичка / incandescent lamp
- 2 – халогенна лампа / halogen lamp

- 4 – Димиращ електронен трансформатор / dimmable electronic transformer
- 5 – класически трансформатор / classical transformer

- 6 – икономия на енергия при димиране на газоразрядна лампа / dimmable energy saving CFL lamp
- 7 – димируема светодиодна лампа / dimmable LED lamp

- 8 – без икономия на енергия при димиране на газоразрядна лампа / non-dimmable energy saving CFL lamp
- 9 – недимируема светодиодна лампа / non-dimmable LED lamp

бележки / remarks

- (F) филтър EM27
- препоръчва се използване на филтър EM27 / it is recommended to use filter EM27
- всички управлявани лампи трябва да са от един тип / all controlled lamps must be the same
- таблицата за товара е валидна за лампи с коефициент на мощност PF>0,5 / table of loads is valid for lamps with power factor PF>0.5

- включване, изключване и димиране на лампа /
on / off swithcing and dimming of lamp

избор на цвят и настройка на интензитета на LED частта /
LED unit colour and intensity level selection

★ функция за „нулиране“ (RESET) /
“RESET” function

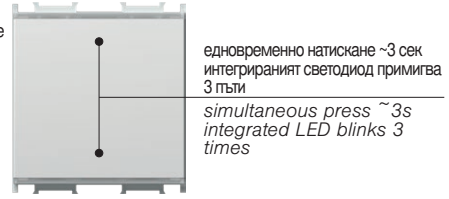

* - препоръчва се при инсталиране на димер и смяна на лампи
- задължително, ако се използват лампи, не позволяващи димиране
- функцията за „нулиране“ (RESET) не е налична при използване на
двупроводно свързване
- възможно е само за EM25

- it is recommended at dimmer installation
and lamp replacement
- mandatory when using non-dimmable lamps
- “RESET” function is not possible when using
two-wire connection
- only possible on EM25

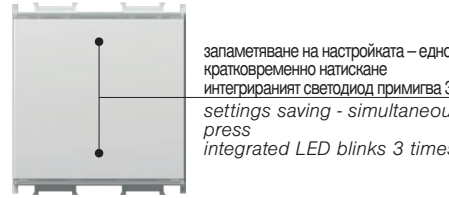

предупреждения във връзка с инсталирането /
installation precautions

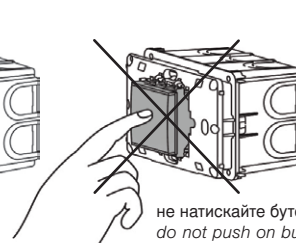
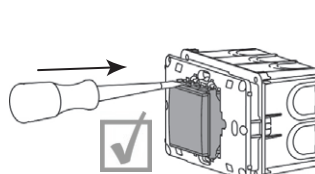
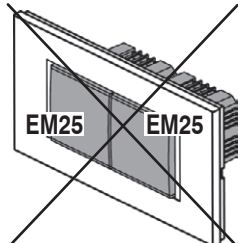
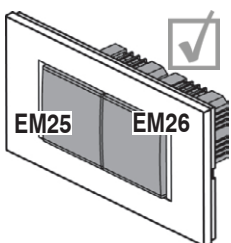

БУТОННО УСТРОЙСТВО ЗА УПРАВЛЕНИЕ 2М

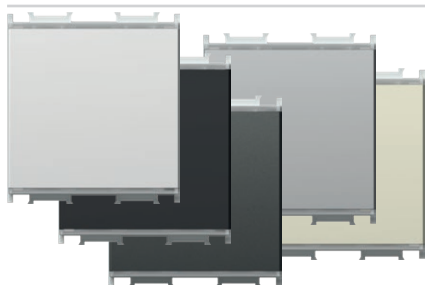

- EM26PW
- EM26MW
- EM26SB
- EM26AT
- EM26ES
- EM26IW

- свързано към универсален димер EM25 дава възможност за управление на лампи със същата функционалност (максимално до) като EM25
- захранващо напрежение 230 V~ 50 Hz
- в съответствие с EN 60669-1 и EN 60669-2-1
- винтови контакти за проводници 1,5 mm² (макс. въртящ момент за притягане 0,4 Nm)



PUSH-BUTTON CONTROL UNIT 2M

- connected to universal dimmer EM25 allows controlling of lamps with same functionality as EM25
- supply voltage 230V~ 50Hz
- in accordance with EN 60669-1 and EN 60669-2-1
- screw contacts 1.5mm² (max. tightening torque 0.4Nm)

(1)двупроводно свързване
two-wire connection

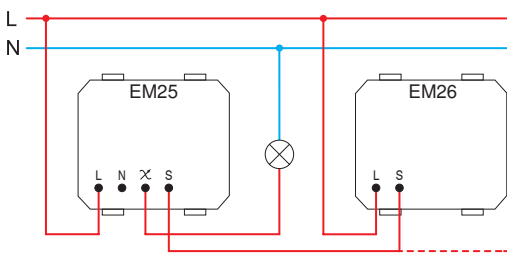

- двупроводното свързване дава възможност за димиране на лампи, позволяващи димиране
- при двупроводно свързване всяко допълнително устройство за управление увеличава минималния товар с 25 W
- two-wire connection allows dimming of dimmable lamps
- in a two-wire connection each additional control unit increases the minimum load by 25W

(2)трипроводно свързване
three-wire connection

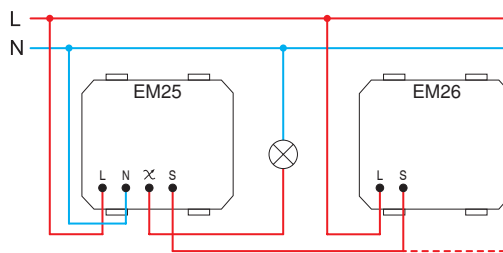

- трипроводното свързване дава възможност за димиране на лампи, позволяващи димиране, и на някои видове не позволяващи димиране светодиодни и газоразрядни лампи
- three-wire connection allows dimming of dimmable lamps and some of non-dimmable LED and CFL lamps

КОМПЛЕКТ КЛЮЧ-УНИВЕРСАЛЕН ДИМЕР ЗА АКТИВЕН ИНДУКТИВЕН КАПАЦИТИВЕН ТОВАР 0-300 W 2M PP OL20

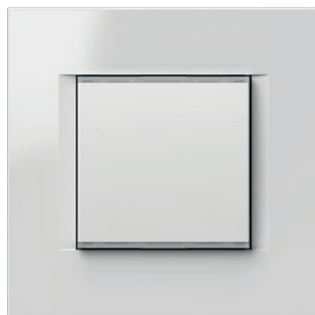

- EM25PPOL20

- комплектът съдържа димер EM25, монтажна рамка 2М и панел LINE 2М PW
- за технически подробности вижте EM25

SET SWITCH / DIMMER UNIVERSAL RLC
0-300W 2M PP OL20

- set includes dimmer EM25, mounting frame 2M and cover plate LINE 2M PW
- for technical details see EM25



2M = 45 x 45

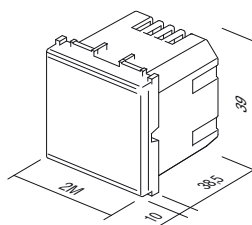

EM25
EM26



EM27

ЧЕСТОТЕН ФИЛТЪР

- честотен филтър за EM25
- изображението е символично

FREQUENCY FILTER

- frequency filter for EM25
- image is symbolic

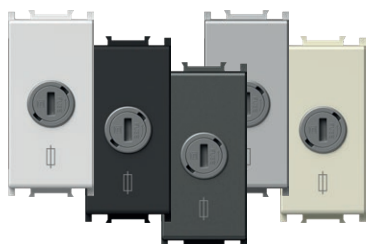
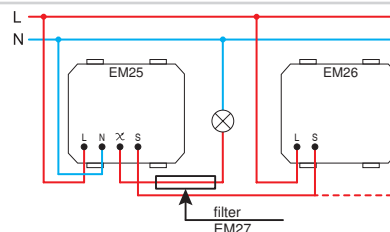

- EM28PW
- EM28MW
- EM28SB
- EM28AT
- EM28ES
- EM28IW

КОНЗОЛА НА СТОПЯЕМИЯ ПРЕДПАЗИТЕЛ 230 V~, 50Хц 1М

- Захранващо напрежение: 230 V~, 50Хц
- Предпазител: MAX 10 A / 230 V~, 50Hz
- Сечение на жиците: 0,75 – 2,5 мм2
- Температура при функциониране: 0 до +40 °C
- Температура при съхраняване: -5 до +60 °C
- Брой на конзолите: 2; 1x L, 1x Изход (L')
- Съответства на стандарт: EN 60669-2-1:2004 + A1:2009 + A12:2010 EN 60669-1:2018



MELT FUSE HOUSING 230 V~, 50 Hz 1M

- Supply voltage: 230 V~, 50 Hz (fuse not included)
- Fuse: MAX 10 A / 230 V~, 50Hz
- Wire cross-section: 0.75 - 2.5mm²
- Operating temperature: 0 to +40°C
- Storage temperature: -5 to +60°C
- Number of connectors: 2; 1x L, 1x Output (L')
- Corresponds to the standard: EN 60669-2-1:2004 + A1:2009 + A12:2010 EN 60669-1:2018

ПРЕДПАЗИТЕЛ

EM29

- T5AH 250V, 5x20mm
- пакетирано по 10 броя.

FUSE T5AH

- T5AH 250V, 5x20mm
- packed in packs of 10 pcs



- EM31PW
- EM31MW
- EM31SB
- EM31AT
- EM31ES
- EM31IW

КЛЮЧ IR 5 A 230 V~ 1M

- инфрачервен ключ IR
- захранващо напрежение: 230 V~ ±10 % 50 Hz
- реле: 5 A/250 V~ (нулевата стойност)
- клас на защита: IP40
- сечение на проводниците при контакта 0,75 - 2,5 мм²
- ъгъл на откриване: до 110° при 20° C
- разстояние на откриване: прил. 8 m при 20° C
- регулируема продължителност: от прил. 5 сек до 12 мин
- регулиране на яркостта на осветлението: от прил. 5 до 200 лукса
- работна температура: от 0° C до +40° C
- не е подходящо за инсталиране в конзоли с дълбочина 45 mm и конзоли за външен монтаж CUBO IP20
- само за използване на закрито



IR SWITCH 5A 230V~ 1M

- IR infrared switch
- supply voltage: 230V~, ±10 % 50Hz
- relay: 5A / 250V~, (zero crossing)
- protection rating: IP40
- cross-section of wires at the contact terminal: 0.75 - 2.5 mm²
- detection angle: up to 110° at 20°C
- detection area: approx. 8 m at 20°C
- adjustability of duration: from approx. 5 s to 12 min
- adjustability of brightness: from approx. 5 to 200 LUX
- operating temperature: from 0°C to +40°C
- not suitable for installation in 45 mm deep boxes and surface mount box CUBO IP20
- only for indoor usage



КЛЮЧ IR 5A 230V~ 2M

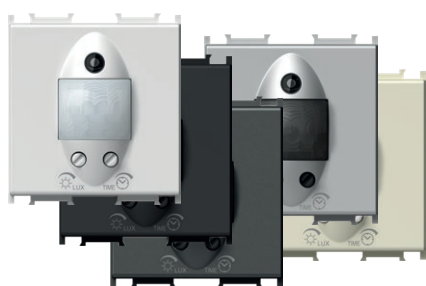

- EM32PW
- EM32MW
- EM32SB
- EM32AT
- EM32ES
- EM32IW



- инфрачервен ключ IR
- захранващо напрежение: 230 V~ ±10 % 50 Hz
- реле: 5 A/250 V~ (нулевата стойност)
- клас на защита: IP40
- сечение на проводниците при контакта 0,75 - 2,5 mm²
- ъгъл на откриване: до 110° при 20° C
- разстояние на откриване: прил. 8 m при 20° C
- регулируема продължителност: от прил. 5 сек до 12 мин
- регулиране на яркостта на осветлението: от прил. 5 до 200 лукса
- работна температура: от 0° C до +40° C
- не е подходящо за инсталиране в конзоли с дълбочина 45 mm и конзоли за външен монтаж CUBO IP20
- само за използване на закрито



IR SWITCH 5A 230V~ 2M

- IR infrared switch
- supply voltage: 230V~, ±10 % 50Hz
- relay: 5A / 250V~, (zero crossing)
- protection rating: IP40
- cross-section of wires at the contact terminal: 0.75 - 2.5 mm²
- detection angle: up to 110° at 20°C
- detection area: approx. 8 m at 20°C
- adjustability of duration: from approx. 5 s to 12 min
- adjustability of brightness: from approx. 5 to 200 LUX
- operating temperature: from 0°C to +40°C
- not suitable for installation in 45 mm deep boxes and surface mount box CUBO IP20
- only for indoor usage



СЕНЗОРЕН КЛЮЧ 5 A 230 V~ 1M



- EM33PW
- EM33MW
- EM33SB
- EM33AT
- EM33ES
- EM33IW



- Захранващо напрежение: 230 V~, 50 Хц
- Изход: Реле 5 А / 230 V~, 50 Хц
- Сечение на жиците: 0,75 – 2,5 mm2
- Температура при функциониране: 0 до +40 °С
- Температура на съхранение: -5 до +60 °С
- Функции: Нощен ключ, Ключ с детектор на движението, Ключ с детектор на присъствието
- Индикация на програмата: Обозначение на предния капак
- Брой на бутоните/контролите: 3
- Вид на функционирането на бутоните/контролите: Ротация
- Настройване на времето на включване на изхода: От около 10 сек. до 12 мин.
- Зона на долавяне: Около 8 m
- Ъгъл на долавяне: До 110°
- Настройване на осветлението: От ~5 до ~200 лукса
- Брой на конзолите: 4; 1x N, 1x L, 1x Изход (L'), 1x Управляем вход (S)
- Възможност за управляем вход: Да. Включване на сигнала на мрежовото напрежение (230 V~) към елемент S.
- Допълнително: »Zero Crossing« (превключване на ключа при преминаването на напрежението през 0 V)
- Потребление в режим OFF / ON Съответства на стандарт: 0.3 W / 0.6 W EN 60669-2-1:2004 + A1:2009 + A12:2010 EN 60669-1:2018



SENSOR SWITCH 5A 230V~ 1M

- Supply voltage: 230 V~, 50Hz
- Output: Relay 5 A / 230 V~, 50 Hz
- Wire cross section: 0.75 - 2.5 mm²
- Operating temperature: 0 to + 40 °C
- Storage temperature: -5 to + 60 °C
- Functions: Night switch, Motion detection switch, Presence Detection Switch
- Programme indication: Mark on front cover
- Number of keys/controls: 3
- Operation Type of Key/Control: Rotation
- Adjusting the output activation time: From approx. 10 sec to 12 minutes
- Detection Area: Approximately 8 m
- Detection angle: Up to 110°
- Illumination adjustment: From ~5 to ~200 lux
- Number of connectors: 4; 1x N, 1x L, 1x Output (L'), 1x Controlled input (S)
- Controlled input option: Yes. Connection of the main voltage signal (230 V~) to terminal S.
- Optional: "Zero Crossing" (switching the switch when the voltage passes through 0 V)
- Power consumption in the OFF/ON state Corresponds to the standard: 0.3 W / 0.6 W EN 60669-2-1:2004 + A1:2009 + A12:2010 EN 60669-1:2018

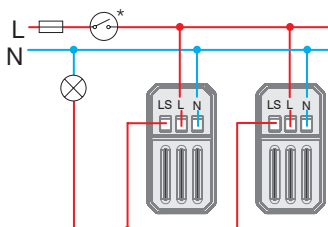

EM31 / EM32

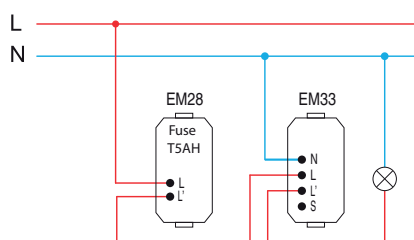

EM33

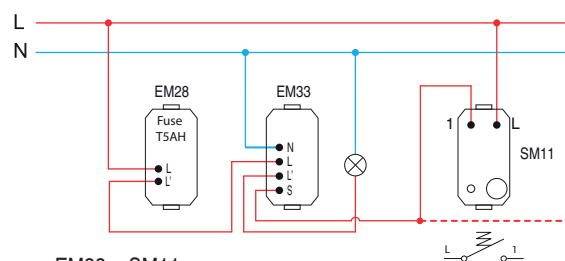

EM33 + SM11

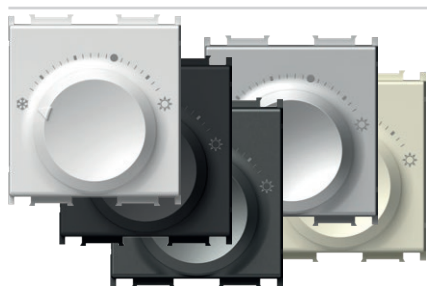

- EM38PW
- EM38MW
- EM38SB
- EM38AT
- EM38ES
- EM38IW

ТЕРМОСТАТ ЗА ОТОПЛЕНИЕ 5(2) А 230 V~ 2М

- режим на работа: отопление
- захранване: 230 V~, 50 Hz
- импулс на напрежение: 4 kV
- консумация на енергия: < 0,5 W
- изход: 2 А (макс. 5 А); 230 V~, 50 Hz
- изходен порт: NO (макс. 10 актуатора)
- зона на регулация: +5° C до +30° C
- защита против замръзване: +5° C
- хистерезис: 0,5 K
- защита: IP30
- вид на сензора: Bimetal
- вид на електрическия изход: пружинни клеми
- вид на проводниците:
- 0,75 – 1,5 кв. мм (с гъвкава жица);
- 1,0 – 2,5 кв. мм (с твърда жица)
- в съответствие с Директива DIN EN 60730



HEATING THERMOSTAT 5(2)A 230V~ 2M

- operation mode: heating
- power supply: 230 V~, 50 Hz
- voltage pulse: 4 kV
- energy consumption: < 0.5 W
- output: 2 A (max. 5 A); 230 V~, 50 Hz
- switching output: NO (max. 10 actuators)
- regulation range: +5°C to +30°C
- frost protection: +5°C
- hysteresis: 0.5 K
- protection: IP30
- sensor type: Bimetal
- type of electrical connection: Spring-loaded contacts
- type of conductors: 0.75 – 1.5 mm² (flexible-stranded core);
- 1.0 – 2.5 mm² (solid core)
- in compliance with Directive DIN EN 60730

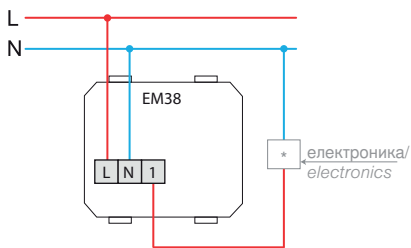

ТЕРМОСТАТ ЗА ОТОПЛЕНИЕ/ОХЛАЖДАНЕ 3(1,5) А 230 V~ 2М



- EM39PW
- EM39MW
- EM39SB
- EM39AT
- EM39ES
- EM39IW

- режим на работа: отопление/охлаждане
- захранване: 230 V~, 50 Hz
- импулс на напрежение: 4 kV
- консумация на енергия: < 0,5 W
- изход: 1,5 А (макс. 3 А); 230 V~, 50 Hz
- изходен порт:
 - ключ за превключване (макс. 5 актуатора)
- зона на регулация: +5° C до +30° C
- защита против замръзване: +5° C
- хистерезис: 0,5 K
- защита: IP30
- вид на сензора: Bimetal
- вид на електрическия изход: пружинни клеми
- вид на проводниците:
 - 0,75 – 1,5 кв. мм (с гъвкава жица);
 - 1,0 – 2,5 кв. мм (с твърда жица)
- в съответствие с Директива DIN EN 60730



HEATING/COOLING THERMOSTAT 3(1.5)A 230V~ 2M

- operation mode: cooling/heating
- power supply: 230 V~, 50 Hz
- voltage pulse: 4 kV
- energy consumption: < 0.5 W
- output: 1 A (max. 3 A); 230 V~, 50 Hz
- switching output: mode selector switch (max. 5 actuators)
- regulation range: +5°C to +30°C
- frost protection: +5°C
- hysteresis: 0.5 K
- protection: IP30
- sensor type: Bimetal
- type of electrical connection: Spring-loaded contacts
- type of conductors: 0.75 - 1.5mm² (flexible-stranded core); 1.0 - 2.5 mm² (solid core)
- in compliance with the Directive DIN EN 60730

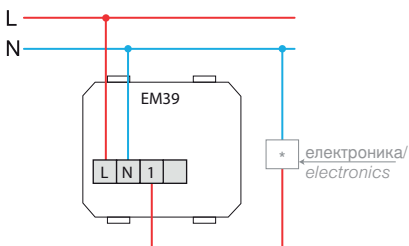

2M = 45 x 45

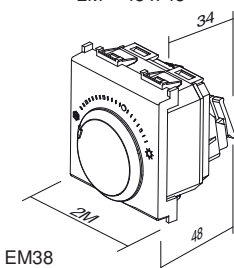

EM38

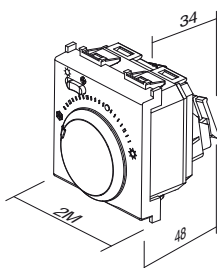

EM39

МОНТАЖНА РАМКА С ВИНТОВЕ ЗА ТЕРМОСТАТИ FANTINI COSMI 3M



NM39

- монтажна рамка с винтове за термостати Fantini Cosmi 3M
- подходяща за използване с моделите еднокдневни термостати Fantini Cosmi CH121 и CH123
- подходяща за използване с моделите едноседмични термостати Fantini Cosmi CH141A и CH143A
- за монтаж в правоъгълни конзоли 3M
- подходящо за сглобяване с панели PURE, Line, Soft

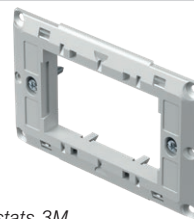

MOUNTING FRAME WITH SCREWS FOR FANTINI COSMI THERMOSTATS 3M

- mounting frame with screws for Fantini Cosmi thermostats 3M
- suitable for use with Fantini Cosmi daily thermostats models CH121 and CH123
- suitable for use with Fantini Cosmi weekly thermostats models CH141A and CH143A
- for mounting in rectangular boxes 3M
- suitable for assembling with cover plates PURE, Line, Soft

КЛЮЧ С КАРТА 16 A / 230 V~, 50 Hz 3M



- EM46PW
- EM46MW
- EM46SB
- EM46AT
- EM46ES
- EM46IW

- Захранващо напрежение: 230 V~, 50 Hz
- Изход: Реле 16 A / 230 V~, 50 Hz
- Сечение на жицата: 0,75 – 4,0 mm²
- Температура при функциониране: 0 до +40 °C
- Температура на съхраняване: -5 до +60 °C
- Функция: Ключ с карта с последващо изключване
- Закъснение на изключването: ~23 с
- Брой на изходите: 6; 2x N, 2x L и 2x изход (C и NO)
- Потребление в режим OFF / ON: 0.5 W / 1.2 W



CARD SWITCH 16 A / 230 V~, 50 Hz 3M

- Supply voltage: 230 V~, 50 Hz
- Output: Relay 16 A / 230 V~, 50 Hz
- Wire cross-section: 0.75 - 4.0 mm²
- Operating temperature: 0 to +40°C
- Storage temperature: -5 to +60°C
- Function: Card switch with a delayed break
- Break delay: ~23 s
- Number of ports: 6; 2x N, 2x L and 2x output (C and NO)
- Power consumption in the OFF/ON state: 0.5 W / 1.2 W

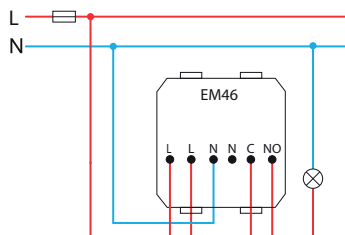
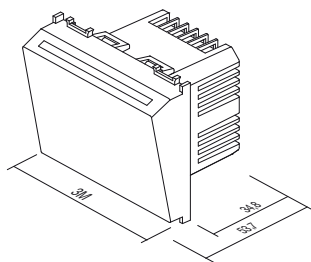



■ EM44BK

КЛЮЧ С КАРТА ЗА ИКОНОМИЯ НА ЕНЕРГИЯ RF HF 13,56 MHz 3M

- електронен ключ с карта за RFID ISO карта
- захранва се от релейно устройство EM49 по кабел конектори тип RJ12
- изходът трябва да се свързва с изхода на релейно устройство EM49
- закъснение при изключване на „главното захранване“ 15-20 сек. при изваждане на картата
- закъснение 1 мин. при изключване на „HVAC“ (Отопление, вентилация и климатизация) при изваждане на картата, когато се отворят врати на балкон или прозорец
- в съответствие с EN 61000-6-1
- картата не е включена в доставката
- не е предназначено за контрол на достъпа

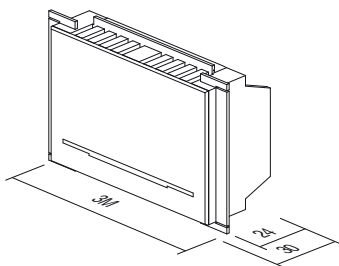
*ENERGY SAVER CARD SWITCH RF HF 13,56MHz 3M*

- *electronic card switch for RFID ISO card*
- *supply from relay unit EM49 through cable connectors RJ12*
- *output to be connected to relay output unit EM49*
- *15-20s "main power" switch off delay with card withdrawal*
- *1 min "HVAC" switch off delay with card withdrawal when balcony doors or windows opened*
- *in accordance with EN 61000-6-1*
- *card is not included*
- *not for access control*

КАРТА ISO

EM47

- карта ISO
- за комбинация с ключ с карта EM46
- размер: 85x54 mm

CARD ISO

- *ISO card*
- *for combination with card switch EM46*
- *size: 85x54 mm*

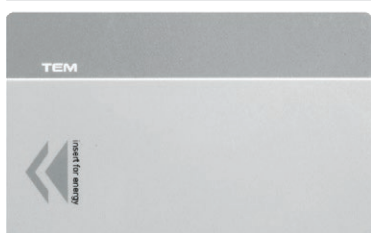

УСТРОЙСТВО ЗА УПРАВЛЕНИЕ ЗА ИКОНОМИЯ НА ЕНЕРГИЯ 2x16 A 250 V ~



EM49

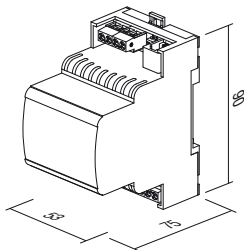

- релейно устройство за ключове с карта EM44
- захранващо напрежение 230 V~ 50 Hz
- в съответствие с EN 61000-6-1
- за монтаж върху DIN релса 35 mm, 3 MU
- входът и изходът зависят от реализацията: единична или двойна стая

ENERGY SAVER CONTROL UNIT 2x16A 250V~

- relay unit for card switches EM44
- supply voltage 230V~ 50Hz
- in accordance with EN 61000-6-1
- mounting on DIN rail 35mm, 3MU
- input and output depending on implementation: single or double room



РАЗПРЕДЕЛИТЕЛ SPL-1



EM45

- служи за свързване на два периферни модула EM44 към релейно устройство EM49
- комуникационен конектор тип RJ12
- размер: 37 x 30 x 27 mm

SPLITTER SPL-1

- used to connect two peripheral modules EM44 to relay unit EM49
- communication connector RJ12
- size: 37 x 30 x 27 mm

схема на свързване при реализация за единична стая / wiring diagram for single room implementation



схема на свързване при реализация за двойна стая / wiring diagram for double room implementation



съединителен кабел RJ12 между EM44 и EM49 / connection cable RJ12 between EM44 and EM49



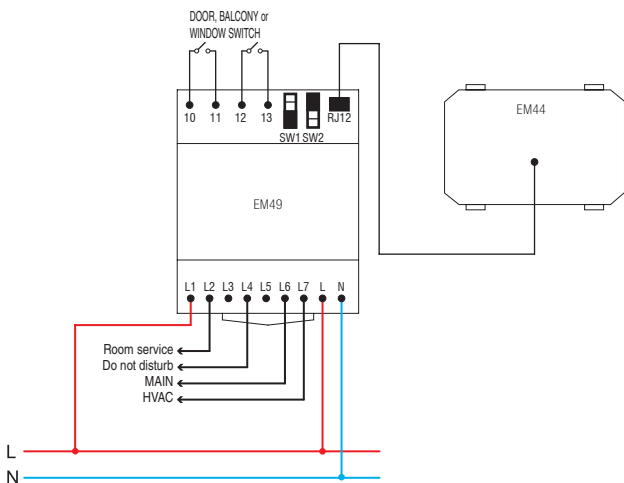
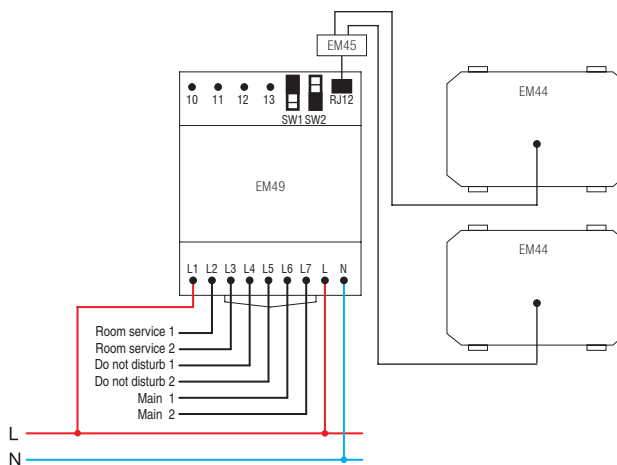
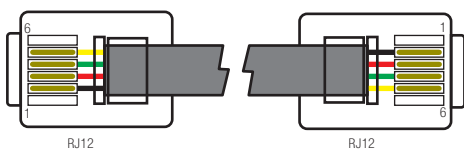
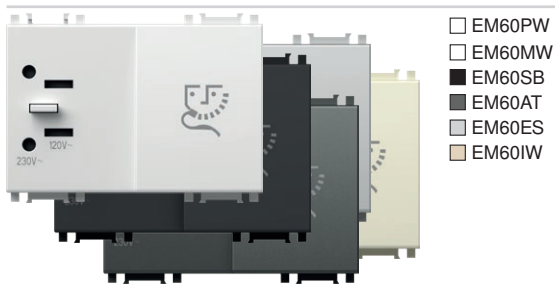

- EM60PW
- EM60MW
- EM60SB
- EM60AT
- EM60ES
- EM60IW

КОНТАКТ ЗА САМОБРЪСНАЧКА 230 V~/120 V~ 3M

- захранващо устройство с разделителен трансформатор 20 VA
- захранване: 230 V~ 50-60 Hz
- изход:
- 230 V~ за 2P 2.5 A Europlug или
- 120 V~ за 2P 15 A Американски щепсел
- клас II
- в съответствие с EN 61558-2-5

SOCKET SHAVER 230V~/120V~ 3M

- shaver supply unit with isolating transformer 20VA
- supply: 230V~ 50-60Hz
- output:
- 230V~ for 2P 2.5A Europlug or
- 120V~ for 2P 15A American plug
- Class II
- in accordance with EN 61558-2-5

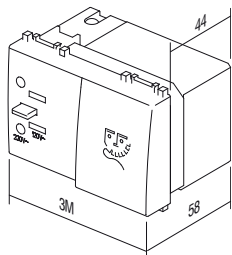

3M = 67,5 x 45

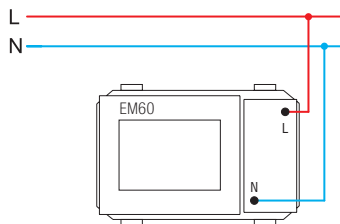

EM57

АВАРИЙНА СВЕТОДИОДНА ЛАМПА 230V~50 Hz, 0,5 W, NiMH 2h 2M

- аварийна светодиодна лампа
- с опция за употреба и като ръчна лампа (издърпващ се механизъм)
- захранващо напрежение 230 V~50 Hz, 1xLED 0,5 W
- Акумулаторна NiMH батерия 3,6V 140 mAh, сменяема
- автономна работа 2 часа, зареждане 36 часа
- устройство клас II
- в съответствие с EN60598-1, EN60598-2-2, EN62471, EN55015:2006, EN61547

LED EMERGENCY LIGHT 230V~50Hz, 0.5W, NiMH 2h 2M

- emergency LED lamp
- option to use it as a hand lamp (pull-out mechanism)
- supply voltage 230V~50Hz, 1xLED 0.5W
- NiMH accumulator 3,6V 140mAh, replaceable
- autonomy 2h, charging 36h
- class device II
- in accordance EN60598-1, EN60598-2-2, EN62471, EN55015:2006, EN61547

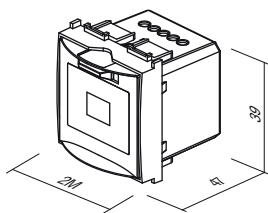
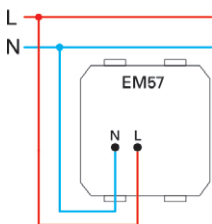
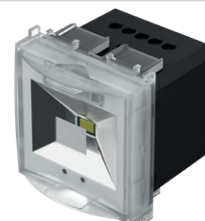

СВЕТОДИОДНО АВАРИЙНО ОСВЕТЛЕНИЕ 250 V~ 0,90 W, NiCd 3h 7M



□ EM55

- светодиодна лампа за аварийно осветление
- захранващо напрежение 250 V~ 50 Hz 3 x LED 0,3 W, 10000 mcd, 6500 K
- NiCd акумулатор 4,8V 400 mAh, позволяващ смяна
- автономно действие 3 часа, зареждане 24 часа
- клас II
- в съответствие с EN 60598-1, EN 60598-2-2, EN 60598-2-22



LED EMERGENCY LIGHT 250V~ 0.90W, NiCd 3h 7M

- emergency LED lamp
- supply voltage 250V~ 50Hz 3x LED 0,3W, 10000mcd, 6500K
- NiCd accumulator 4,8V 400 mAh, replaceable
- autonomy 3h, charging 24h
- Class II
- in accordance with EN 60598-1, EN 60598-2-2, EN 60598-2-22

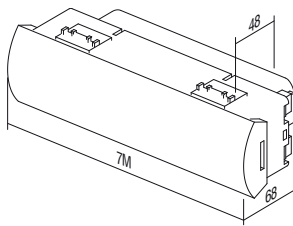

7M = 157 X 45

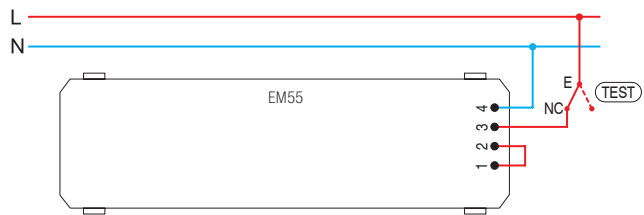



- EM69PW
- EM69MW
- EM69SB
- EM69AT
- EM69ES
- EM69IW

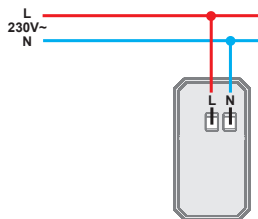
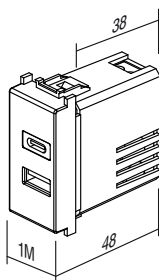

ЗАРЯДНО УСТРОЙСТВО USB PD 20W

- USB драйвър с осигуряване на мощност до 20W.
- за зареждане на електронни устройства чрез стандартен USB порт (съвместимо и с устройствата Apple).
- захранване: 100-230 V~ 50/60 Hz
- потребление в режим на функциониране 420 mA при 100 V~/220 mA при 230 V~
- потребление в изключен режим: <100 mW при 230 V~
- изходна мощност: Макс 20W.

Изход/ порт:

- USB тип C 5.0 VDC 3.0A; 9.0 VDC 2.2 A 12.0 VDC 1.67 A (PD 20W)
- USB тип A 5.0 VDC 3.0A; 9.0 VDC 2.0 A 12.0 VDC 1.5 A (QC 18W)
- USB A+C: 5 VDC 3A
- тип конектор: 1 x USB A; 1 x USB C
- средна ефективност в активен режим: 86%
- ефективност при минимално натоварване (10%): 81%
- температура при функциониране 0 °C/+ 45 °C (вътрешно ползване)
- клас IP защита: IP20, само за вътрешно ползване.
- клас на безопасност на устройството II
- защита от пренапрежение (EN 60364-4-44): клас III
- прикрепване на проводниците с винтове макс. 2.5 кв. мм
- устройство с отстояние на контактите мин. 3 мм
- не е подходящо за вграждането в конзоли с дълбочина 45 мм и конзоли за външен монтаж CUBO IP20.

Съответства на:

- Директиви: BT, EMC, RoHS, ErP
- Стандарти: EN IEC 62368-1, EN 55032, EN55035, EN IEC 61000-3-2, EN 61000-3-3, EN 50563, EN IEC 63000
- Допълнителни регулации: (EU) n. 2019/1782 REACh, n. 1907/2006 – чл. 33. Изделието може да съдържа следи от олово.



USB POWER SUPPLY UNIT PD 20W

- 20 W USB power delivery power supply unit
- for charging of electronic devices via a standard USB port (also compatible with Apple devices)
- power supply: 100-230V~ 50/60Hz
- power consumption: 420mA at 100V~/1220mA at 230V~
- standby power consumption: <100mW at 230V~
- Output power: 20 W Max
- Output:
- USB tip C: 5.0 VDC 3.0A; 9.0 VDC 2.2 A; 12.0 VDC 1.67 A (PD 20W)
- USB tip A: 5.0 VDC 3.0A; 9.0 VDC 2.0 A; 12.0 VDC 1.5 A (QC 18W)
- USB A+C: 5 VDC 3A
- connector type: 1x USB A; 1x USB C
- average efficiency in active mode: 86%
- efficiency with low load (10%): 81%
- operating temperature: 0 °C/+45 °C (indoor use)
- IP protection class: IP20, indoor use only
- class device II
- overvoltage category (EN 60364-4-44): Class III
- screw contacts: max. 2.5 mm²
- device with a contact gap of at least 3mm

Conformity:

- Directive: BT, EMC, RoHS, ErP
- Standards: EN IEC 62368-1, EN 55032, EN55035, EN IEC 61000-3-2, EN 61000-3-3, EN 50563, EN IEC 63000
- External power supplies regulation: (EU) n. 2019/1782 REACh, n. 1907/2006 – art.33. The product may contain traces of lead.

LED АМБИЕНТАЛНА ЧАСТ ЕДНОЦВЕТНА 250 V~ 0,8 W 2M

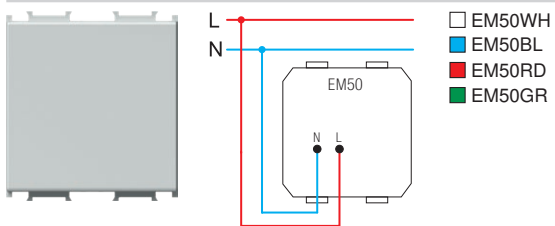

- светодиодна лампа за обозначаване на стъпала
- захранващо напрежение 230 V~ 50 Hz 0,8 W, 6500 K
- клас II
- в съответствие с EN 60598-1
- възможно е да се използва за осветяване на знаци за сигнализация и упътване с отпечатване на текст по желание на клиента с лазерен печат върху дифузора

LED AMBIENT UNIT MONOCOLOUR 250V~ 0,8W 2M

- step marker LED unit
- supply voltage 230V~ 50Hz 0,8W, 6500K
- Class II
- in accordance with EN 60598-1
- optional usage for directional signalization with customized laser printing on diffuser



ДВУЦВЕТНА СВЕТОДИОДНА ЛАМПА 250 V~ 2 x 0,4 W 2M

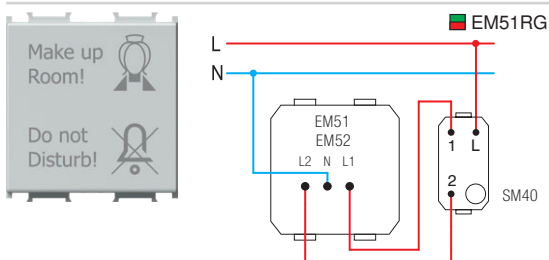

- светодиодна лампа с двоен сигнален цвят (червен/зелен)
- захранващо напрежение 230 V~ 50 Hz 2 x 0,4 W, 6500 K
- клас II
- в съответствие с EN 60598-1
- върху дифузора има графично изображение, както е показано
- възможно е отпечатване по желание на клиента с лазерен печат върху дифузора

LED LAMP DUAL COLOR 250V~ 2x0,4W 2M

- signaling dual color (red/green) LED lamp
- supply voltage 230V~ 50Hz 2x0,4W, 6500K
- Class II
- in accordance with EN 60598-1
- diffuser includes graphics as shown
- possible customized laser printing on diffuser



ДВУЦВЕТНА СВЕТОДИОДНА 3D ЛАМПА 250 V~ 2 x 0,4 W 2M

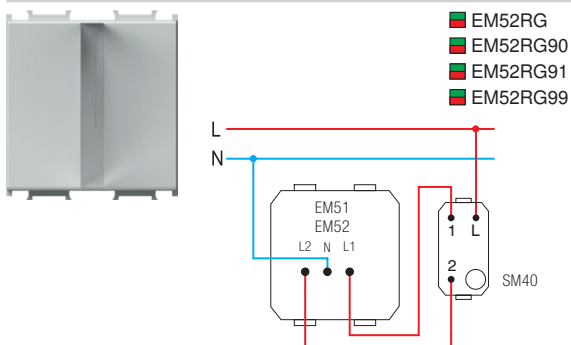

- сигнална светодиодна лампа, два цвята (червен/зелен) с 3D символ
- захранващо напрежение 230 V~ 50 Hz 2 x 0,4 W, 6500 K
- клас II
- в съответствие с EN 60598-1
- възможно е отпечатване на графично изображения по желание на клиента
- 90 символ „Мъже“, 91 символ „Жени“, 99 символ по поръчка

LED LAMP 3D DUAL COLOR 250V~ 2x0,4W 2M

- signalling LED lamp, dual color (red/green) with 3D symbol
- supply voltage 230V~ 50Hz 2x0,4W, 6500K
- class II
- in accordance with EN 60598-1
- possible customized graphics on request
- 90 male symbol, 91 female symbol, 99 symbol on request

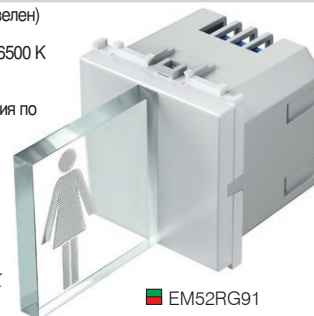

EM52RG91



EM52RG90

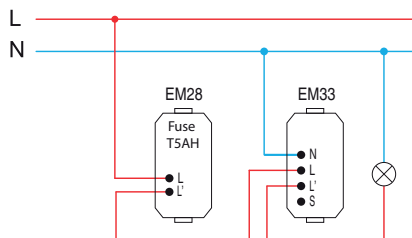
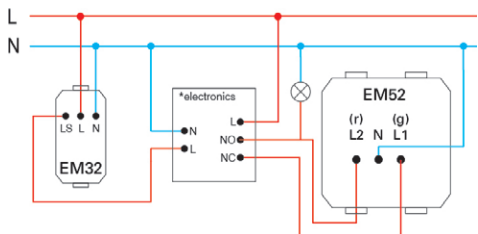

2M = 45 x 45

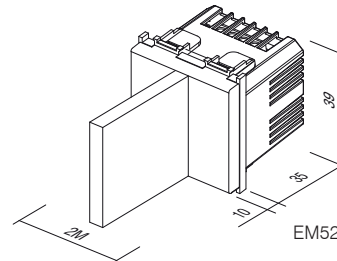
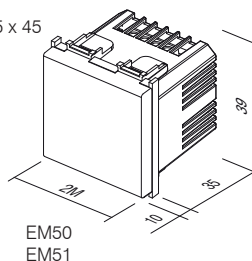



- EM71PW
- EM71MW
- EM71SB
- EM71AT
- EM71ES
- EM71IW

ПРЕВКЛЮЧВАТЕЛ С ПРЪСТОВ ОТПЕЧАТЪК BIOPASS 2M

- Превключвател с пръстов отпечатък с включен вътрешен релейен модул и захранване
- Капацитет: 500 пръстови отпечатъка
- Лесно управление чрез мобилното приложение X-Manager
- Захранващо напрежение: 8 – 30 V – DC или AC (с включено захранване)
- Капацитивен сензор
- 2 изходни релета
- Максимално напрежение/ток в релето: 40 V/3 A
- Време за задействане на релето: 1 – 10 сек
- Максимална мощност: 3,6 W
- 256-битова шифрована връзка между превключвателя и вътрешния релейен модул
- Комплект с включени NM24 монтажна рамка и OS20 декоративна рамка.

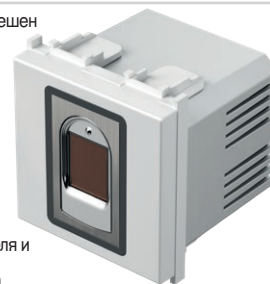

FINGERPRINT SWITCH BIOPASS 2M

- fingerprint switch with included internal relay unit and power supply
- capacity: 500 fingerprints
- easy management via X-Manager mobile app
- power supply voltage: 8-30V – DC or AC (power supply included)
- capacitive sensor
- 2 output relays
- maximum voltage/current on relay: 40V/3A
- relay triggering time: 1-10 sec
- maximum power: 3.6W
- 256-bit encrypted link between switch and internal relay unit
- Set also includes NM24 mounting frame and OS20 decorative cover plate.

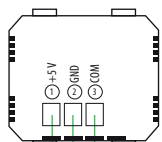
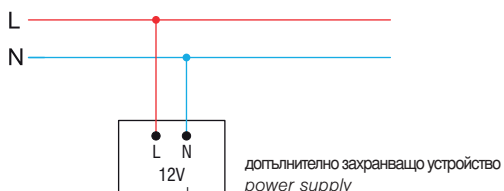

вградено релейно устройство
interior relay unit

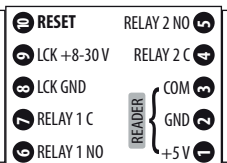

електрическа
ключалка
electric lock

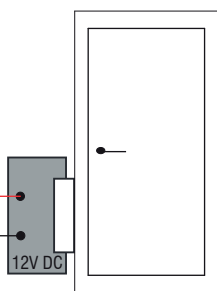

X-Manager app



външно устройство
exterior unit

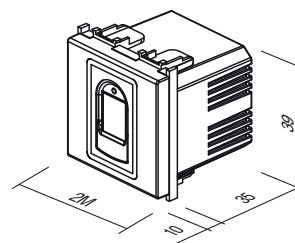



- EM82PW
- EM82MW
- EM82SB
- EM82AT
- EM82ES
- EM82IW



МУЛТИФУНКЦИОНАЛЕН ВРЕМЕВИ КЛЮЧ

- Захранващо напрежение: 230 V~, 50 Hz
- Изход: Реле 16 A/250 V~, 50 Hz
- Сечение на проводниците: 0,75 – 4,0 mm²
- Работна температура: 0 до +40° C
- Температура при съхранение: -5 до +60° C
- Функции: **таймер, реле (управляващ контакт), Ключ, ключ със сензорно задействане**
- Индикация на програмата/състоянието: RGB LED
- Брой на бутоните: 2
- Тип функциониране на бутон: Капацитивно
- Брой на портовете: 6 – 2x N, 2x L, 1x изход (L), 1x управляващ вход (S)
- Възможност за управляващ вход Да. Включване на сигнала за мрежово напрежение (230 V~) към съединителен елемент S.
- Приложено функциониране »нулевата стойност« (превключване на контакта при преминаване на напрежението през 0 V)
- Ключ EM82 НЕ Е ПОДХОДЯЩ за вграждане в конзола под мазилка на дълбочина 45 мм и в монтажна рамка CUBO IP20.
- Ключът е предназначен за използването във вътрешни помещения, защитени от въздействието на влага.

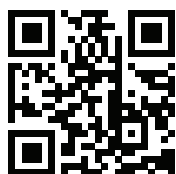

MULTIPURPOSE TIMER SWITCH EM82

- Supply voltage: 230 V~, 50Hz
- Output: Rele 16 A / 250 V~, 50Hz
- Wire cross section: 0,75 – 4.0 mm²
- Operating temperature: 0 to + 40 °C
- Storage temperature: -5 to + 60 °C
- Functions: **Timer, Relay (controlled switch), Switch, Push button**
- Program/status indication: RGB LED
- Number of buttons: 2
- Push button operation type: Capacitive
- Number of ports: 6 - 2x N, 2x L, 1x Output (L'), 1x Controlled input (S)
- Controlled input option: Yes. Connection of the main voltage signal (230 V~) to terminal S.
- Implemented "zero crossing" operation (switching the switch when the voltage passes through 0 V)
- Power consumption in the OFF / ON state: 0.3 W / 1.0 W
- The EM82 switch is NOT SUITABLE for installation in concealed boxes with a depth of 45 mm and CUBO IP20 housing.
- The switch is intended for indoor use, protected from moisture.

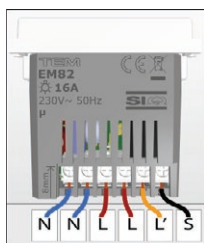
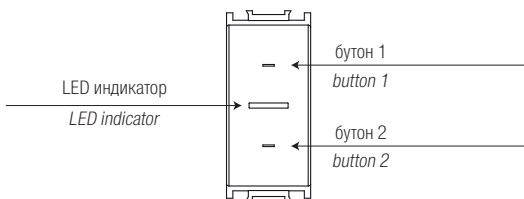

- N Неутрален проводник
- L Фазов проводник
- L' Изход (управлявана фаза)
- S Входен управляван сигнал (230 V~)

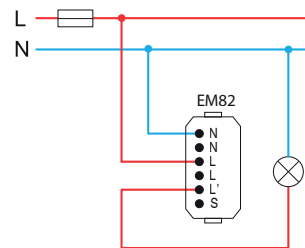

EM82 is in a SWITCH or a TIMER mode

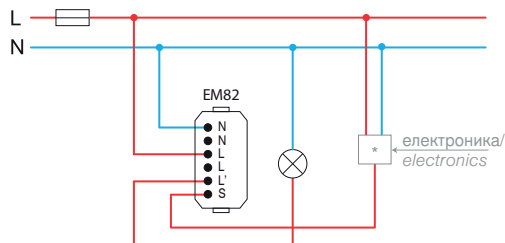

EM82 is in a RELAY mode

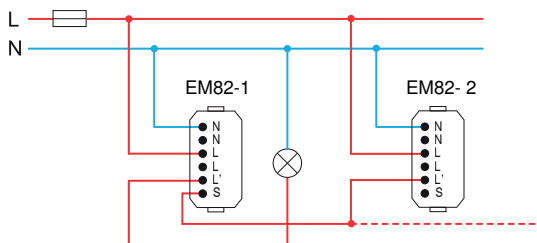

EM82-1 is in a SWITCH or a TIMER mode
EM82-2 is in a PUSH BUTTON mode

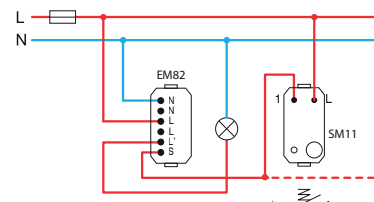

EM82 is in a SWITCH or a TIMER mode

	1	2	3	4	5	6	7	8
Max.	16 A	16 A	16 A	8 A	8 A	5 A cos φ=0.6	200 VA	200 VA

- 1 - incandescent lamp
- 2 - halogen lamp
- 3 - resistive heating element
- 4 - electronic transformer
- 5 - classical transformer
- 6 - motor
- 7 - energy saving CFL lamp
- 8 - LED lamp

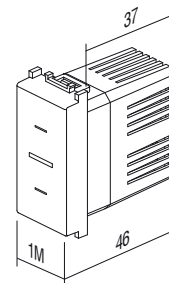

Operation of the control signal S – MODE 1

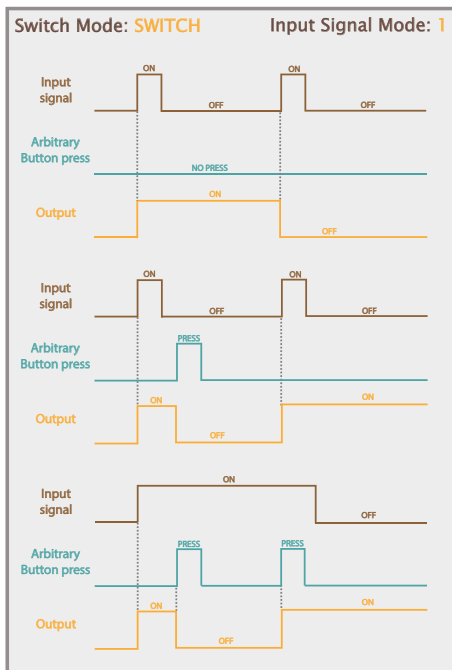

Display of the operation of the external signal S and buttons in the SWITCH operating mode and external signal in MODE 1

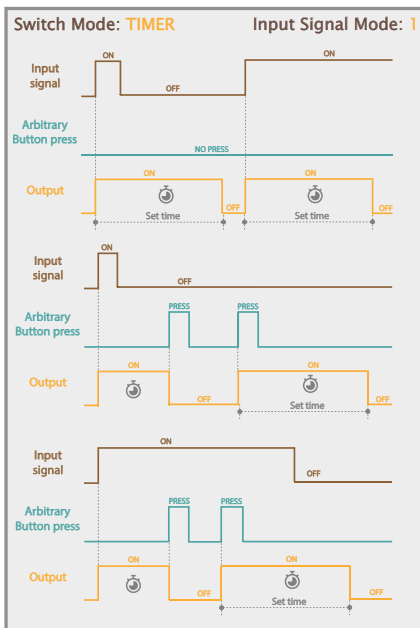

Display of the operation of the external signal S and buttons in the TIMER operating mode and external signal in MODE 1

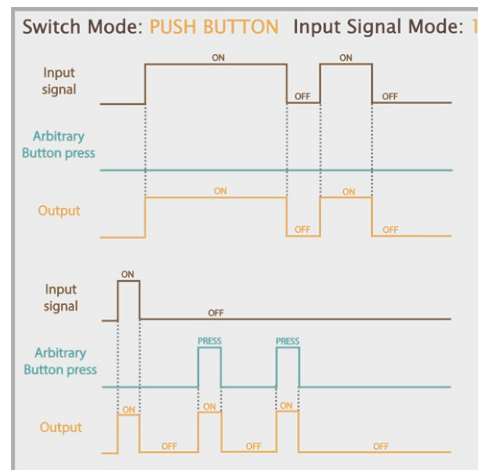

Display of the operation of the external signal S and buttons in the PUSH BUTTON operating mode and external signal in MODE 1

OPERATION OF THE CONTROL SIGNAL S – MODE 2

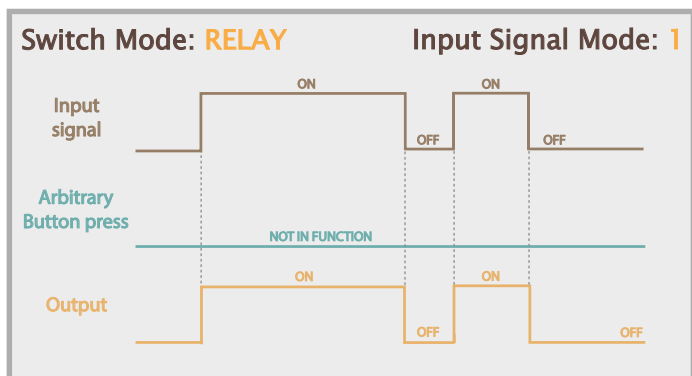

Display of the operation of the external signal S and buttons in the RELAY operating mode and external signal in MODE 1

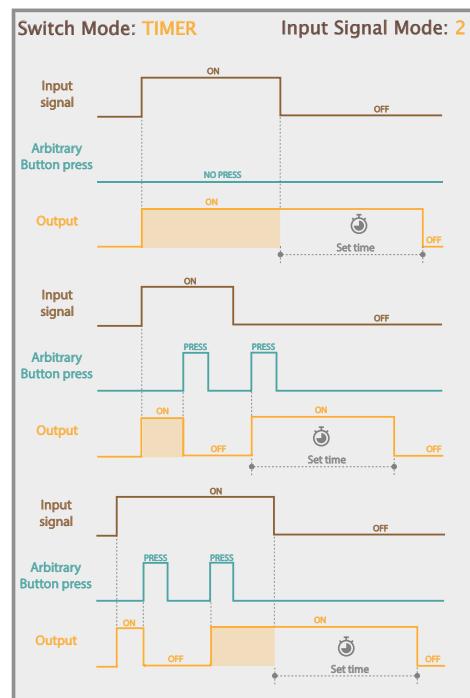

Display of the operation of the external signal S and buttons in the TIMER operating mode and external signal in MODE 2

Operating mode settings of the external control signal S

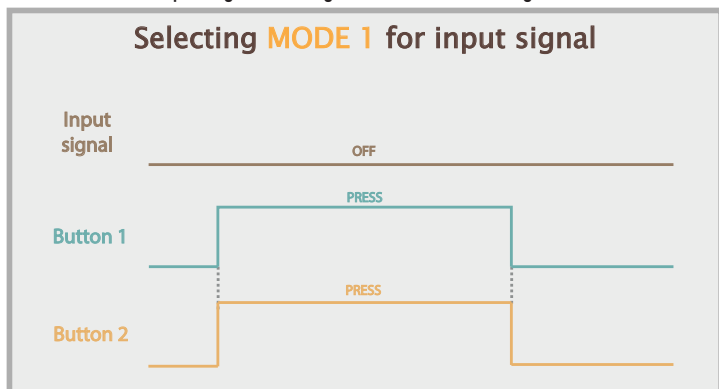

Setting the operating mode of the input signal S for MODE 1

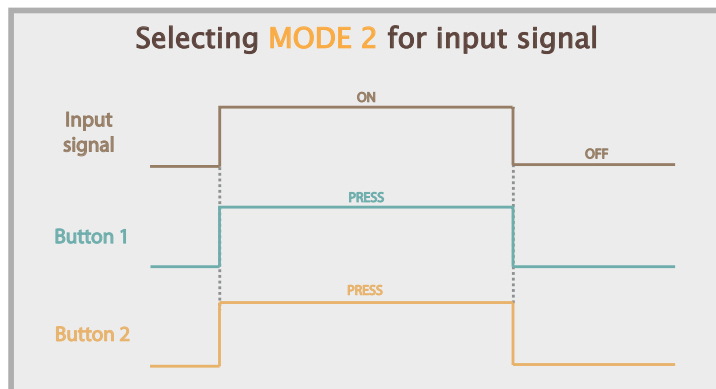

Setting the operating mode of the input signal S for MODE 2

ЗУМЕР 8 VA 230 V~1M

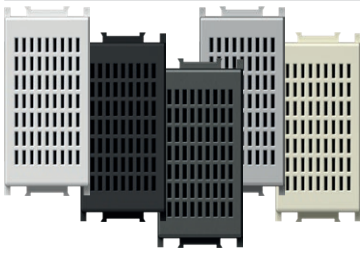

- EM90PW
- EM90MW
- EM90SB
- EM90AT
- EM90ES
- EM90IW

- сигнален зумер
- издаването на звук продължава колкото управляващото действие
- захранващо напрежение 230 V ~ 50 Hz 8 VA

BUZZER 8VA 230V~1M

- signal buzzer
- the sound emission has the same lasting time as the control operation
- supply voltage 230V~ 50Hz 8VA

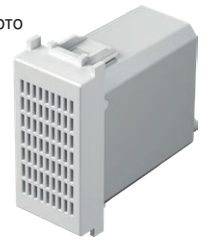

ЗУМЕР 8 VA 230 V~1M

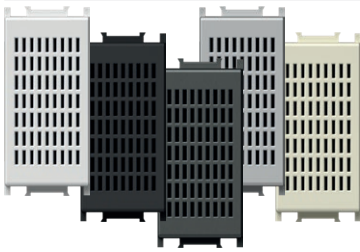

- EM91PW
- EM91MW
- EM91SB
- EM91AT
- EM91ES
- EM91IW

- сигнален зумер
- издаването на звук продължава колкото управляващото действие
- захранващо напрежение 230 V ~ 50 Hz 8 VA

BUZZER 8VA 12V~1M

- signal buzzer
- the sound emission has the same lasting time as the control operation
- supply voltage 12V~ 50Hz 8VA

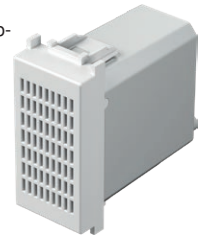

ЗВЪНЕЦ 8 VA 230 V~1M

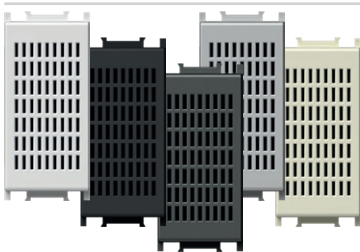

- EM92PW
- EM92MW
- EM92SB
- EM92AT
- EM92ES
- EM92IW

- сигнален звънец
- издаването на звук продължава колкото управляващото действие
- захранващо напрежение 230 V~ 50 Hz 8 VA

BELL 8VA 230V~1M

- signal bell
- the sound emission has the same lasting time as the control operation
- supply voltage 230V~ 50Hz 8VA

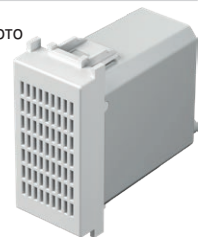

ЗВЪНЕЦ 8 VA 12V~1M

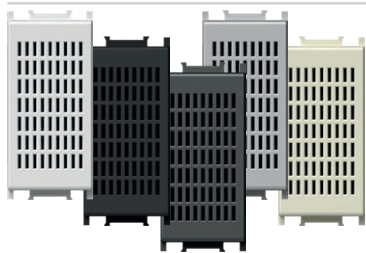

- EM93PW
- EM93MW
- EM93SB
- EM93AT
- EM93ES
- EM93IW

- сигнал звънец
- издаването на звук продължава колкото управляващото действие
- захранващо напрежение 12 V~ 50 Hz 8 VA

BELL 8VA 12V~1M

- signal bell
- the sound emission has the same lasting time as the control operation
- supply voltage 12V~ 50Hz 8VA



ЕЛЕКТРОНЕН ЗВЪНЕЦ 230V~ 6mA rms 1M

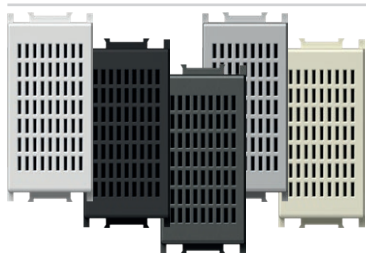

- EM94PW
- EM94MW
- EM94SB
- EM94AT
- EM94ES
- EM94IW

- захранване: 230 В~ 50/60 Хц
- консумация за мелодия 1: 4, 7 mA rms
- консумация за мелодия 2: 5, 9 mA rms
- ниво на звука на мелодия 1: 2, 86 Дб
- ниво на звука на мелодия 2: 86 Дб
- температура при функциониране: 0 C/45 C (при вътрешно използване)
- температура при съхранение: -20 C/ 50 C
- IP защитен клас: IP20 (само за вътрешно използване)
- клас на безопасност на устройството: II
- защита от прекалено напрежение (EN62109): клас III
- прикрепване на водещите елементи с болтове: макс 2, 5 кв. мм
- устройство с оттегляне на контактите: мин 3 мм
- Леснодостъпен прекъсвач ключ може да бъде монтиран нагоре по веригата на звънеца
- В съответствие с Директивата за безопасност на нисковолтови електрически съоръжения (LVD) и Директивата относно електромагнитната съвместимост (EMC)

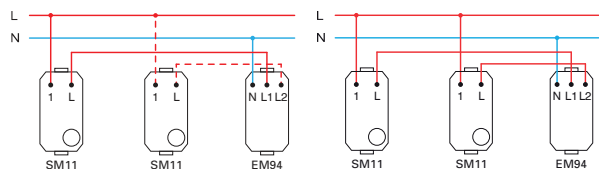
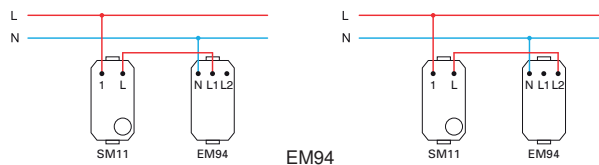

ELECTRONIC BELL 230V~ 6mA rms 1M

- power supply 230 V~ 50/60 Hz
- power consumption when playing melody 1: 4.7 mA rms
- power consumption when playing melody 2: 5.9 mA rms
- sound level of melody 1: 90.5 dB
- sound level of melody 2: 86 dB
- operating temperature 0°C/45°C (indoor use)
- storage temperature: -20°C /50°C
- IP protection class: IP20 (indoor use only)
- class device II
- overvoltage category (EN62109): Class III
- screw contacts: max. 2.5 mm²
- device with a contact gap of at least 3 mm
- an easily accessible cut-off switch must be installed upstream from bell
- complies with EMC & LVD directives

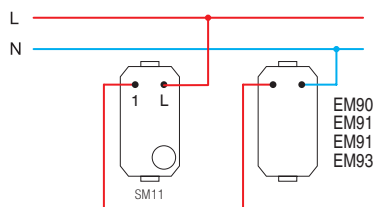
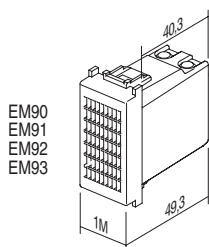

РЕГУЛАТОР НА СИЛАТА НА ЗВУКА 100 V AUDIO LINE 35 W 2M



- EM95PW
- EM95MW
- EM95SB
- EM95AT
- EM95ES
- EM95IW

- регулатор на силата на звука (атенюатор) за аудиосистеми 100 V
- номинална мощност 35 W (макс. 45 W), 6 нива регулиране на силата на звука
- подходящо за инсталиране в конзоли (с мин. дълбочина 60 mm)
- не е подходящо за инсталиране в конзоли с дълбочина 45 mm и конзоли за външен монтаж CUBO IP20
- само за използване на закрито



- VOLUME CONTROL 100V AUDIO LINE 35W 2M**
- volume control (attenuator) for 100V audio systems
 - power rating 35W (max.45W), 6 steps volume control
 - suitable for boxes min. 60 mm deep
 - not suitable for installation in 45 mm deep boxes and surface mount boxes CUBO IP20
 - for indoor use only

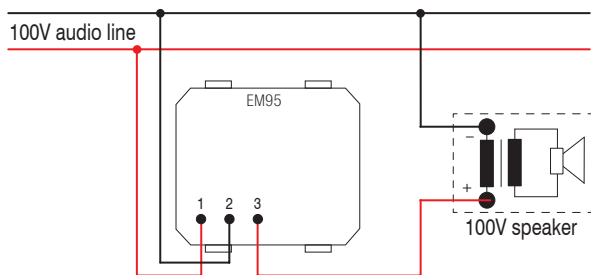

РЕГУЛАТОР НА СИЛАТА НА ЗВУКА 4-8 Ω 35 W 2M

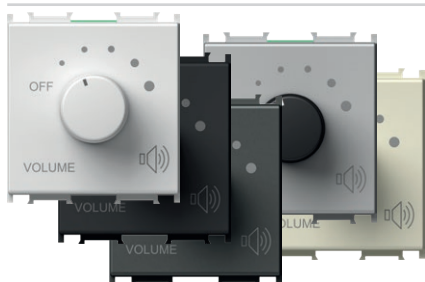

- EM96PW
- EM96MW
- EM96SB
- EM96AT
- EM96ES
- EM96IW

- регулатор на силата на звука (атенюатор) за изходи с ниско напрежение 4-8 Ω, 35 W
- допуска се свързване на HI-FI устройства
- номинална мощност 35 W, 6 нива на регулиране на силата на звука
- подходящо за инсталиране в конзоли (с мин. дълбочина 60 mm)
- не е подходящо за инсталиране в конзоли с дълбочина 45 mm и конзоли за външен монтаж CUBO IP20
- само за използване на закрито



- VOLUME CONTROL 4-8 Ω 35W 2M**
- volume control (attenuator) for low voltage outputs 4-8 Ω, 35W
 - power rating 35W, 6 steps volume control
 - suitable for boxes min. 60 mm deep
 - not suitable for installation in 45 mm deep boxes and surface mount boxes CUBO IP20
 - for indoor use only

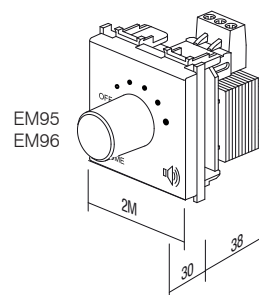
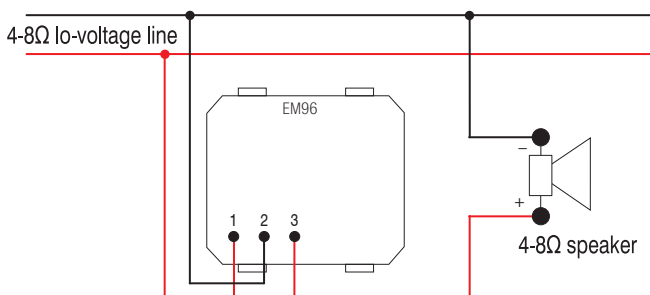



тип type	описание description	технически данни technical data	размер size	цвет colour	допълнителна информация 1 optional data 1
CM10	КОМПЛЕКТ КОНТАКТИ 2xШУКО SOCKET SET 2x SCHUKO	2P+E 16A 250V~	4M	<input type="checkbox"/> PW снежнобял цвят polar white	<input type="checkbox"/> OL панел LINE cover plate LINE
CM11	КОМПЛЕКТ КОНТАКТИ 3xШУКО SOCKET SET 3x SCHUKO	2P+E 16A 250V~	7M	<input type="checkbox"/> MW Бял матов цвят matte white	<input type="checkbox"/> OS панел SOFT cover plate SOFT
CM15	КОМПЛЕКТ СЪЕДИНИТЕЛНИ ПРОВОДНИЦИ LINK WIRE SET	3x1.5mm ²	1M	<input checked="" type="checkbox"/> SB сензорен бутон, черен soft touch black	
·	·	·	·	<input checked="" type="checkbox"/> AT антрацит anthracite	
·	·	·	·	<input type="checkbox"/> ES сребрист elox silver	
·	·	·	·	<input type="checkbox"/> IW слонова кост ivory white	

КОМПЛЕКТ КОНТАКТИ 2 x ШУКО 2P+E 16 A 250 V~ 4M

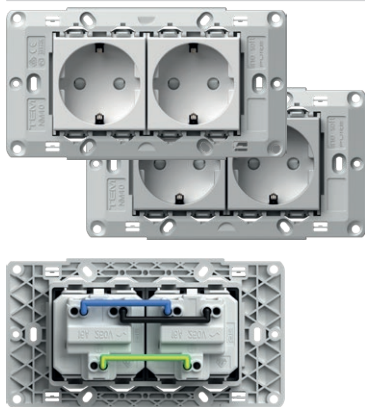

- CM10PW
- CM10ES

- комплект контакти 2 x шуко VM10 2P+E 16 A 250 V~
- предварително свързани съединителни проводници CM16
- с монтажна рамка 4M без винтове
- за закрепване към монтажна рамка използвайте винтове CM17, CM18 или CM19
- винтови контакти 1,5 - 2,5 mm²
- в съответствие с IEC 60884-1, CEE7

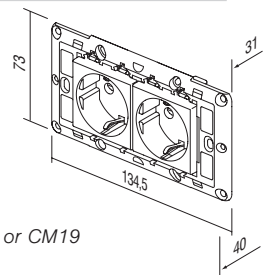

SOCKETS SET 2x SCHUKO 2P+E 16A 250V~ 4M

- socket set 2x schuko VM10 2P+E 16A 250V~
- prewired with link wires CM16
- with mounting frame 4M without screws
- for mounting frame fixing use screws CM17, CM18 or CM19
- screw contacts 1.5-2.5 mm²
- in accordance with IEC-60884-1, CEE7

КОМПЛЕКТ КОНТАКТИ 3 x ШУКО 2P+E 16 A 250 V~ 7M

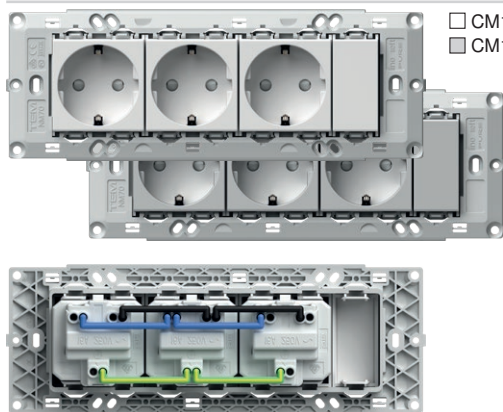

- CM11PW
- CM11ES

- комплект контакти 3 x шуко VM10 2P+E 16 A 250 V~
- предварително свързани съединителни проводници CM16
- с монтажна рамка 7M без винтове
- за закрепване към монтажна рамка използвайте винтове CM17, CM18 или CM19
- винтови контакти 1,5 - 2,5 mm²
- в съответствие с IEC 60884-1, CEE7

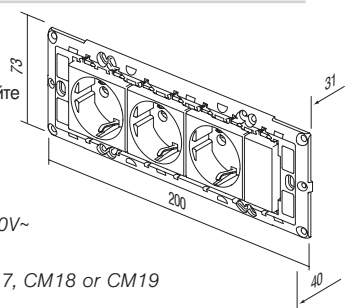

SOCKETS SET 3x SCHUKO 2P+E 16A 250V~ 7M

- socket set 3x schuko VM10 2P+E 16A 250V~
- prewired with link wires CM16
- with mounting frame 7M without screws
- for mounting frame fixing use screws CM17, CM18 or CM19
- screw contacts 1.5-2.5 mm²
- in accordance with IEC-60884-1, CEE7

КОМПЛЕКТ СЪЕДИНИТЕЛНИ ПРОВОДНИЦИ 3 x 1,5 mm², 1M

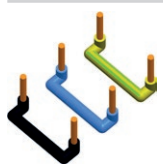

CM15

- комплект съединителни проводници за свързване на два елемента с размер 1M
- съдържа 10 черни, 10 сини и 10 жълти/зелени проводника

LINK WIRE SET 3x1.5mm² 1M

- link wire set to connect two elements size 1M
- includes 10 black, 10 blue and 10 yellow/green wires

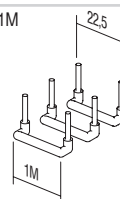

КОМПЛЕКТ СЪЕДИНИТЕЛНИ ПРОВОДНИЦИ 3 x 2,5 mm², 2M

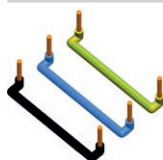

CM16

- комплект съединителни проводници за свързване на два елемента с размер 2M
- съдържа 10 черни, 10 сини и 10 жълти/зелени проводника

LINK WIRE SET 3x2.5mm² 2M

- link wire set to connect two elements size 2M
- includes 10 black, 10 blue and 10 yellow/green wires

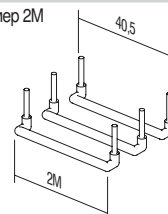

КОМПЛЕКТ ВИНТОВЕ 3,5

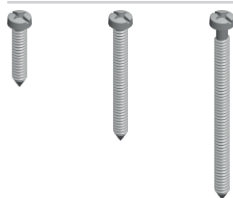

CM17

CM18

CM19

- адаптер за закрепване за монтажни рамки NM30, NM32, NM40, NM41, NM70
- CM17 - l=20 mm, 100 бр.
- CM18 - l=35 mm, 50 бр.
- CM19 - l=50 mm, 50 бр.

SCREW SET 3,5

- screw set for fixing mounting frames NM30, NM32, NM40, NM41, NM70
- CM17 - l=20mm, 100pcs
- CM18 - l=35mm, 50pcs
- CM19 - l=50mm, 50pcs

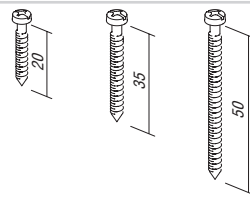

КОМПЛЕКТ КЛЮЧОВЕ С НАДПИС IP44 2M



CM22PW

CM22MW

CM22SB

CM22AT

CM22ES

CM22IW

- за използване във влажни зони
- предоставена защита IP44 за всички ключове Modul
- ключовете и бутоните не са част от комплекта
- панел SOFT 2M с надпис
- в съответствие с IEC 60669-1

SET SWITCHES WITH INSCRIPTION PLATE IP44 2M

- for usage in humid areas
- IP44 protection provides for all Modul switches
- switches and buttons are not part of the set
- include SOFT 2M cover plate with inscription plate and mounting fame
- in accordance with IEC 60669-1



КОМПЛЕКТ КОНТАКТИ С НАДПИС IP44 2M



CM23PW

CM23MW

CM23SB

CM23AT

CM23ES

CM23IW

- за използване във влажни зони
- защита IP44 може да се постигне само в комбинация с покрит контакт (VM11, VM41)
- контактите не са част от комплекта
- панел SOFT 2M с надпис
- в съответствие с IEC 60884-1

SET SOCKETS WITH INSCRIPTION PLATE IP44 2M

- for usage in humid areas
- IP44 protection can be achieved only in combination with covered socket (VM11, VM41)
- sockets are not part of the set
- include SOFT 2M cover plate with inscription plate and mounting fame
- in accordance with IEC 60884-1



КОМПЛЕКТ КЛЮЧОВЕ ЗА БАНЯ 3 x 20 A 250 V~ 4M

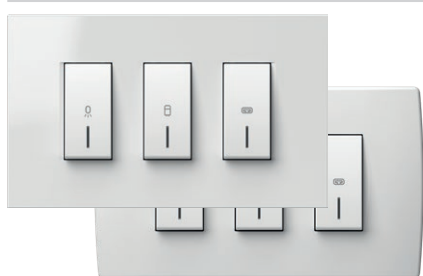

CM25PWOL

CM25IWOL

CM25PWOS

CM25IWOS

- комплект ключове 3 x SM12 20 A 250 V~ с монтажна рамка и панел
- винтови контакти 1,5 - 2,5 mm²
- в съответствие с EN 60669-1

- универсално решение за подновяване на конзоли с размери за закрепване 108-135 mm или конзоли размер 4M
- височина на панела 90 mm

SWITCH SET FOR BATHROOM 3x20A 250V~ 4M

- switch set 3xSM12 20A 250V~ with mounting frame and cover plate
- screw contacts 1.5-2.5mm²
- in accordance with EN 60669-1
- universal solution for renovation on boxes with fixing dimensions 108-135mm or boxes 4M size
- cover plate height 90mm

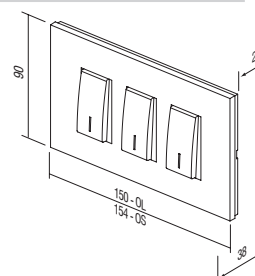



- CM28PW
- CM28MW
- CM28SB
- CM28AT
- CM28ES
- CM28IW

КОМПЛЕКТ ЗА КЛЮЧОВЕ IP44 2M

- за вграждане във влажни помещения;
- IP44 осигурява защита за всички Modul ключове;
- ключовете и бутоните не са съставна част от комплекта;
- панели SOFT 2M без панел с надпис;
- в съответствие с IEC 60669-1

SET SWITCHES IP44 2M

- for usage in humid areas
- IP44 protection provides for all Modul switches
- switches and buttons are not part of the set
- SOFT 2M cover plate without inscription plate
- in accordance with IEC 60669-1



- CM29PW
- CM29MW
- CM29SB
- CM29AT
- CM29ES
- CM29IW

КОМПЛЕКТ ЗА КОНТАКТИ IP44 2M

- за вграждане във влажни помещения;
- защитата IP44 може да бъде постигната само в съчетание с покрит контакт (VM11, VM41);
- контактните гнезда не са съставна част от комплекта;
- панели SOFT 2M без панел с надпис;
- в съответствие с IEC 60884-1

SET SOCKETS IP44 2M

- for usage in humid areas
- IP44 protection can be achieved only in combination with covered socket (VM11, VM41)
- sockets are not part of the set
- SOFT 2M cover plate without inscription plate
- in accordance with IEC 60884-1



МОНТАЖНА РАМКА ЗА КОМПЛЕКТ ЗА БАНЯ 4M

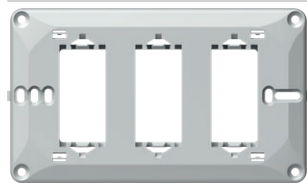

NM41

- универсална монтажна рамка за комплект за баня с винтове
- универсално решение за монтиране върху правоъгълни конзоли с размери за закрепване 108-135 mm или конзоли размер 4M
- в съответствие с EN 60669-1

MOUNTING FRAME BATHROOM SET 4M

- universal mounting frame for bathroom set with screws
- universal solution for mounting on rectangular boxes with fixing dimensions 108-135mm or boxes 4M size
- in accordance with EN 60669-1

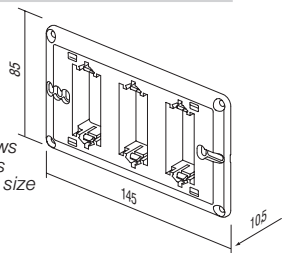

ПАНЕЛ LINE ЗА КОМПЛЕКТ ЗА БАНЯ



- OL41PW
- OL41MW
- OL41NB
- OL41IW
- OL41ES
- OL41SG
- OL41IB
- OL41AT
- OL41TI
- OL41SB

- декоративен панел LINE за комплект за баня
- височина 90 mm
- в съответствие с EN 60669-1

COVER PLATE LINE BATHROOM SET

- decorative cover plate bathroom set LINE
- height 90mm
- in accordance with EN 60669-1

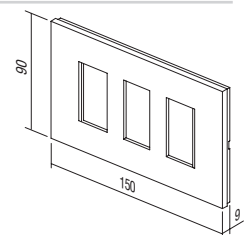

ПАНЕЛ SOFT ЗА КОМПЛЕКТ ЗА БАНЯ



- OS41PW
- OS41MW
- OS41NB
- OS41IW
- OS41ES
- OS41SG
- OS41SB
- OS41WE
- OS41AT
- OS41TI

- декоративен панел SOFT за комплект за баня
- височина 90 mm
- в съответствие с EN 60669-1

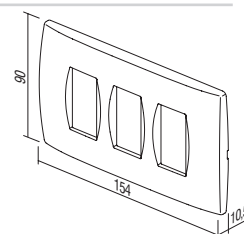

COVER PLATE SOFT BATHROOM SET

- decorative cover plate bathroom set SOFT
- height 90mm
- in accordance with EN 60669-1



МОДУЛ ЗА АНТИБАКТЕРИАЛНА ПРОГРАМА

The diagram illustrates the antibacterial program module components. A hand is shown being washed with water. Labels TM11, AW, and IN are placed above the hand, with lines connecting them to a table below. TM11 points to a button component, AW points to the antibacterial white additive, and IN points to an indicator component.

тип type	описание description	размер size	цвет colour	допълнителна информация 1 optional data 1
TM11	БУТОН BUTTON	1M	<input type="checkbox"/> AW антибактериален, бял antibacterial white	 NT неутрален neutral
TM21	КАПАЧЕ BLANK	1M		
VM10	КОНТАКТ SOCKET	2M		 IN индикатор indicator
.	.	.		
.	.	.		
.	.	.		

МОДУЛ ЗА АНТИБАКТЕРИАЛНА ПРОГРАМА

- ключовете и контактите всеки ден се докосват от много хора, поради което са общо място за развитие и разпространение на бактерии
- благодарение на естествените си антибактериални свойства, среброто вече три хилядолетия се използва като безопасен и ефикасен дезинфектант, тъй като е напълно естествено, здравословно и не уврежда околната среда
- добавката със специални антибактериални йони осигурява дълготрайно надеждна и ефикасна защита против развитието и разпространението на бактерии, микроби и плесени
- антибактериалната защита осигурява поддържане хигиена, чистота и здраве
- антибактериалната програма MODUL е изключително подходяща за приложение в среда със строги изисквания за хигиена (болници, здравни центрове, фармацевтични обекти, домове за възрастни, приюти, лаборатории, ресторанти, хотели, летища, автобусни и железопътни станции, бизнес и търговски зони, обществени институции...)
- проведени са независими лабораторни изпитвания в съответствие с най-високите японски стандарти JIS Z 2801
- ниски разходи за подобряване на човешкото здраве
- структурата и функционалността на антибактериалната програма MODUL позволяват лесно почистване и поддръжка
- антибактериалните бутони, панели и контакти се комбинират с класически монтажни рамки и ключове
- продуктите са обозначени отзад с AW (антибактериален, бял)

ANTIBACTERIAL PROGRAM MODUL

- switches and sockets are daily touched by many people, so this is a common place for development and spread of bacteria
- thanks to its natural antibacterial characteristics silver has been used for three millennia as a safe and effective disinfectant, since it is completely natural, healthy and environmentally friendly
- special antibacterial silver ions additive provides long-term, reliable and effective protection against the development and spread of bacteria, microbes and fungi
- antibacterial protection ensures hygiene, cleanliness and health for people
- perfectly suitable for use in environments with strict hygiene conditions (hospitals, health centers, pharmaceutical facilities, homes for elderly, nursing homes, laboratories, restaurants, hotels, airports, bus and railway stations, business and shopping areas, public institutions ...)
- independent laboratory testings have been carried out in accordance with highest Japanese standards JIS Z 2801
- low cost for providing human health
- design and functionality of antibacterial program MODUL allow easy cleaning and maintenance
- antibacterial buttons, cover plates and sockets are combined with classic mounting frames and switches
- products are labelled on the back with AW (antibacterial white)

ANTIBACTERIAL PROGRAM MODUL

БУТОН 1М



TM11AW

- сменяем бутон 1М, в съответствие с EN 60669-1
- антибактериална защита в съответствие с изискванията по стандарт JIS Z 2801

BUTTON 1M

- replaceable button 1M
- in accordance with EN 60669-1
- antibacterial protection in accordance with JIS Z 2801



БУТОН 1М С ИНДИКАТОР



TM11AWIN

- сменяем бутон 1М, в съответствие с EN 60669-1
- антибактериална защита в съответствие с изискванията по стандарта JIS Z 2801

BUTTON 1M INDICATOR

- replaceable button 1M
- in accordance with EN 60669-1
- antibacterial protection in accordance with JIS Z 2801



БУТОН 2М



TM12AW

- сменяем бутон 2М с носач за бутон
- за надграждане на ключ или бутон от размер 1М към размер 2М
- в съответствие с EN 60669-1
- антибактериална защита в съответствие с изискванията по стандарт JIS Z 2801

BUTTON 2M

- replaceable button 2M with button carrier
- to upgrade switch or push button from size 1M to size 2M
- in accordance with EN 60669-1
- antibacterial protection in accordance with JIS Z 2801



БУТОН 2М С ИНДИКАТОР



TM12AWIN

- сменяем бутон 2М с носач за бутон
- за надграждане на ключ или бутон от размер 1М към размер 2М
- в съответствие с EN 60669-1
- антибактериална защита в съответствие с изискванията по стандарт JIS Z 2801

BUTTON 2M INDICATOR

- replaceable button 2M with button carrier
- to upgrade switch or push button from size 1M to size 2M
- in accordance with EN 60669-1
- antibacterial protection in accordance with JIS Z 2801



КАПАЧЕ 1М



TM21AW

- модулно капаче за покриване на неизползвани позиции
- в съответствие с EN 60669-1
- антибактериална защита в съответствие с изискванията по стандарт JIS Z 2801

BLANK 1M

- blank modul to fill up empty spaces
- in accordance with EN 60669-1
- antibacterial protection in accordance with JIS Z 2801



КАПАЧЕ 2М



TM22AW

- модулно капаче за покриване на неизползвани позиции
- в съответствие с EN 60669-1
- антибактериална защита в съответствие с изискванията по стандарт JIS Z 2801

BLANK 2M

- blank modul to fill up empty spaces
- in accordance with EN 60669-1
- antibacterial protection in accordance with JIS Z 2801

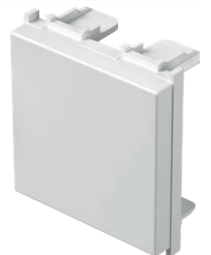



□ VM10AW

КОНТАКТ SCHUKO+KS 2P+E 16A 250V~ 2M

- 2P+E шуко, 16A 250V~, тип VM10
- в съответствие с IEC 60884-1, CEE7
- винтови контакти 1,5 - 2,5 mm²
- вградена защита от докосване на контактите
- антибактериална защита в съответствие с изискванията по стандарт JIS Z 2801

SOCKET SCHUKO+KS 2P+E 16A 250V~ 2M

- 2P+E schuko
- 16A 250V~, type VM10
- in accordance with IEC 60884-1, CEE7
- screw contacts 1.5-2.5 mm²
- built-in contact protection
- antibacterial protection in accordance with JIS Z 2801



□ VM11AW

КОНТАКТ SCHUKO+KS+COVER 2P+E 16A 250V~ 2M

- 2P+E шуко+капак, 16A 250V~, тип VM11
- в съответствие с IEC 60884-1, CEE7
- винтови контакти 1,5 - 2,5 mm²
- вградена защита от докосване на контактите
- антибактериална защита в съответствие с изискванията по стандарт JIS Z 2801

SOCKET SCHUKO+KS+COVER 2P+E 16A 250V~ 2M

- 2P+E schuko+cover
- 16A 250V~, type VM11
- in accordance with IEC 60884-1, CEE7
- screw contacts 1.5-2.5 mm²
- built-in contact protection
- antibacterial protection in accordance with JIS Z 2801



□ VM20AW

КОНТАКТ EURO+KS 2P 10 A 250 V~ 1M

- 2P Euro, 10 A 250 V~, тип VM20
- в съответствие с IEC 60884-1, CEE7
- винтови контакти 1,5 - 2,5 mm²
- вградена защита от докосване на контактите
- антибактериална защита в съответствие с изискванията по стандарта JIS Z 2801

SOCKET EURO+KS 2P 10A 250V~ 1M

- 2P Euro
- 10A 250V~, type VM20
- in accordance with IEC 60884-1, CEE7
- screw contacts 1.5-2.5 mm²
- built-in contact protection
- antibacterial protection in accordance with JIS Z 2801



□ KM11AW

КОНЕКТОР ЗА ТВ КРАЕН 1 dB 1M

- контакт за ТВ краен
- честотен обхват 5÷2400 MHz, затихване < 1 dB
- в съответствие с EN 50083-1
- винтови контакти
- антибактериална защита в съответствие с изискванията по стандарт JIS Z 2801

SOCKET TV END-LINE 1dB 1M

- TV end-line
- frequency range 5÷2400 MHz
- reduction < 1 dB
- in accordance with EN 50083-1
- screw contacts
- antibacterial protection in accordance with JIS Z 2801

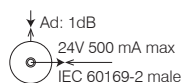

□ KM35AW

АДАПТЕР KS 1M

- KS модул стандарт за закрепване
- AMP, Avaya, Brandrex, FMT, Mfico, Tyco, ...
- комуникационният модул не е включен в доставката
- антибактериална защита в съответствие с изискванията по стандарт JIS Z 2801

ADAPTER KS 1M

- KS keystone fixing standard
- AMP, Avaya, Brandrex, FMT, Mfico, Tyco, ...
- communication module not included
- antibacterial protection in accordance with JIS Z 2801

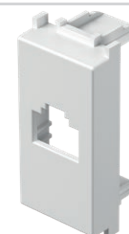

ANTIBACTERIAL PROGRAM MODUL



OS20AW

ПАНЕЛ SOFT 2M

- декоративен панел SOFT 2M
- в съответствие с EN 60669-1
- антибактериална защита в съответствие с изискванията по стандарт JIS Z 2801

COVER PLATE SOFT 2M

- decorative cover plate SOFT 2M
- in accordance with EN 60669-1
- antibacterial protection in accordance with JIS Z 2801



OS24AW

ПАНЕЛ SOFT 2x2M

- декоративен панел SOFT 2x2M
- хоризонтален или вертикален монтаж
- в съответствие с EN 60669-1
- антибактериална защита в съответствие с изискванията по стандарт JIS Z 2801

COVER PLATE SOFT 2x2M

- decorative cover plate SOFT 2x2M
- horizontal or vertical mounting
- in accordance with EN 60669-1
- antibacterial protection in accordance with JIS Z 2801



OS26AW

ПАНЕЛ SOFT 3x2M

- декоративен панел SOFT 3x2M
- хоризонтален или вертикален монтаж
- в съответствие с EN 60669-1
- антибактериална защита в съответствие с изискванията по стандарт JIS Z 2801

COVER PLATE SOFT 3x2M

- decorative cover plate SOFT 3x2M
- horizontal or vertical mounting
- in accordance with EN 60669-1
- antibacterial protection in accordance with JIS Z 2801



OS30AW

ПАНЕЛ SOFT 3M

- декоративен панел SOFT 3M
- в съответствие с EN 60669-1
- антибактериална защита в съответствие с изискванията по стандарт JIS Z 2801

COVER PLATE SOFT 3M

- decorative cover plate SOFT 3M
- in accordance with EN 60669-1
- antibacterial protection in accordance with JIS Z 2801



OS40AW

ПАНЕЛ SOFT 4M

- декоративен панел SOFT 4M
- в съответствие с EN 60669-1
- антибактериална защита в съответствие с изискванията по стандарт JIS Z 2801

COVER PLATE SOFT 4M

- decorative cover plate SOFT 4M
- in accordance with EN 60669-1
- antibacterial protection in accordance with JIS Z 2801

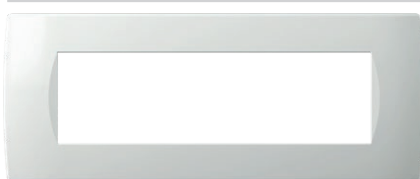

OS70AW

ПАНЕЛ SOFT 7M

- декоративен панел SOFT 7M
- в съответствие с EN 60669-1
- антибактериална защита в съответствие с изискванията по стандарт JIS Z 2801

COVER PLATE SOFT 7M

- decorative cover plate SOFT 7M
- in accordance with EN 60669-1
- antibacterial protection in accordance with JIS Z 2801

базов
basic

PW снежнобял цвят
polar white

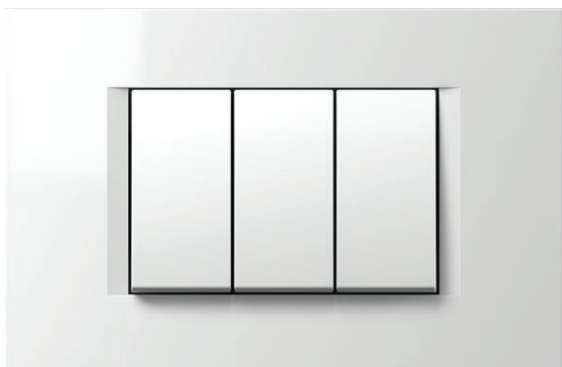

IW слонова кост
ivory white

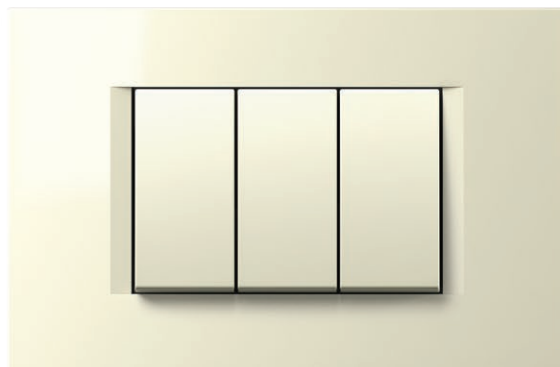

ES сребрист цвят с анодизирано покритие
elox silver



SB сензорен бутон, черен
soft touch black



AT антрацит
anthracite

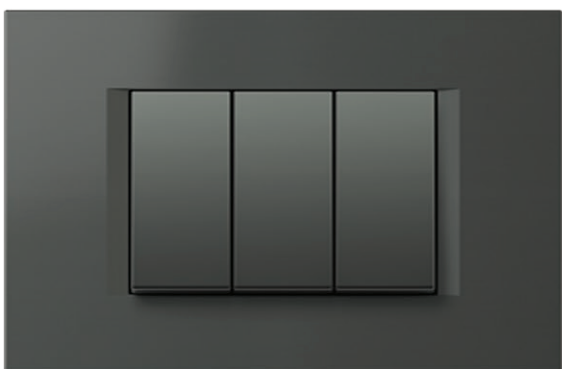

MW Бял матов цвят
matte white

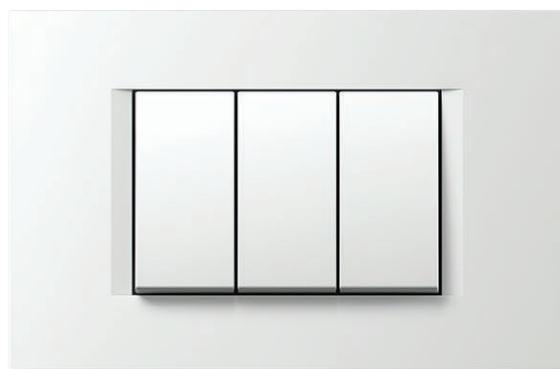

C O V E R P L A T E S L I N E O L

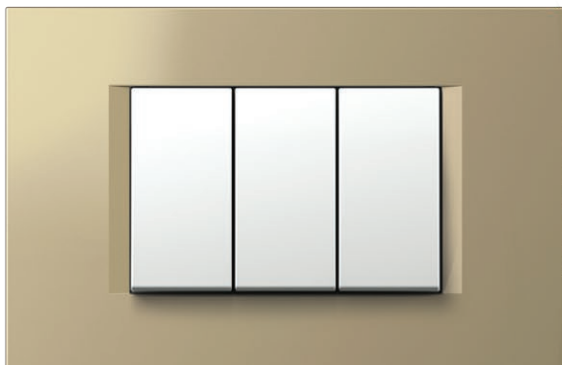
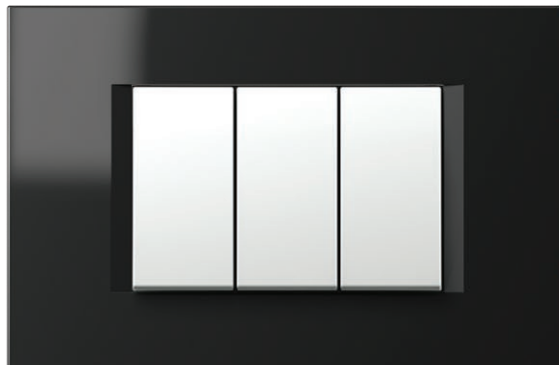
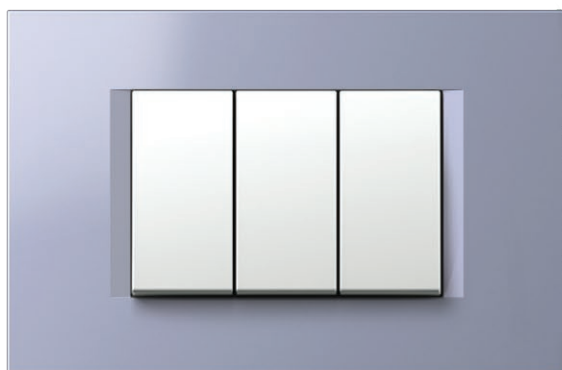
ДЕКОР
decorSG пясъчнозлатист
sand goldNB тъмночерен
night blackIB Импулно синьо
impulse blueTI титан
titaniumSW бял камък
stone white

ПРОДУКТОВА ГАМА ПАНЕЛИ OL

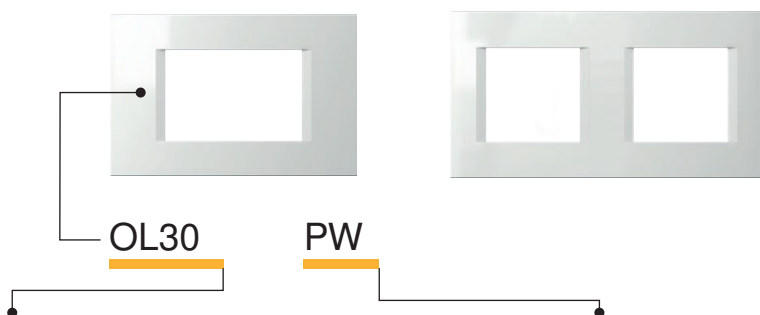

тип type	описание description	размер size	ЦВЯТ colour															
OL10	ПАНЕЛ LINE COVER PLATE LINE	1/2M	<table border="0"> <tr> <td></td> <td>PW</td> <td>снежнобял цвят polar white</td> </tr> <tr> <td></td> <td>SG</td> <td>пясъчнозлатист sand gold</td> </tr> </table>		PW	снежнобял цвят polar white		SG	пясъчнозлатист sand gold									
	PW	снежнобял цвят polar white																
	SG	пясъчнозлатист sand gold																
OL13	ПАНЕЛ LINE COVER PLATE LINE	1/3M	<table border="0"> <tr> <td></td> <td>MW</td> <td>Бял матов цвят matte white</td> </tr> <tr> <td></td> <td>NB</td> <td>тъмночерен night black</td> </tr> </table>		MW	Бял матов цвят matte white		NB	тъмночерен night black									
	MW	Бял матов цвят matte white																
	NB	тъмночерен night black																
OL20	ПАНЕЛ LINE COVER PLATE LINE	2M	<table border="0"> <tr> <td></td> <td>IW</td> <td>слонова кост ivory white</td> </tr> <tr> <td></td> <td>IB</td> <td>Импулсно синьо impulse blue</td> </tr> <tr> <td></td> <td>ES</td> <td>сребрист цвят с анодизирано покритие elox silver</td> </tr> <tr> <td></td> <td>SW</td> <td>бял камък stone white</td> </tr> <tr> <td></td> <td>SB</td> <td>сензорен бутон, черен soft touch black</td> </tr> </table>		IW	слонова кост ivory white		IB	Импулсно синьо impulse blue		ES	сребрист цвят с анодизирано покритие elox silver		SW	бял камък stone white		SB	сензорен бутон, черен soft touch black
	IW	слонова кост ivory white																
	IB	Импулсно синьо impulse blue																
	ES	сребрист цвят с анодизирано покритие elox silver																
	SW	бял камък stone white																
	SB	сензорен бутон, черен soft touch black																



ПАНЕЛ LINE 1/2M



	OL10PW		OL10SG
	OL10MW		OL10NB
	OL10IW		OL10IB
	OL10ES		OL10AT
	OL10SB		OL10TI
			OL10SW

- декоративен панел LINE 1/2M
- в съответствие с EN 60669-1

COVER PLATE LINE 1/2M

- decorative cover plate LINE 1/2M
- in accordance with EN 60669-1

ПАНЕЛ LINE 2M



	OL20PW		OL20SG
	OL20MW		OL20NB
	OL20IW		OL20IB
	OL20ES		OL20AT
	OL20SB		OL20TI
			OL20SW

- декоративен панел LINE 2M
- в съответствие с EN 60669-1

COVER PLATE LINE 2M

- decorative cover plate LINE 2M
- in accordance with EN 60669-1

ПАНЕЛ LINE 2x2M

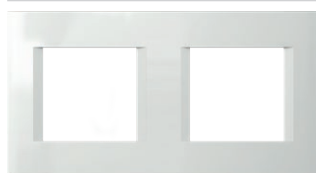

	OL24PW		OL24SG
	OL24MW		OL24NB
	OL24IW		OL24IB
	OL24ES		OL24AT
	OL24SB		OL24TI
			OL24SW

- декоративен панел LINE 2x2M
- хоризонтален или вертикален монтаж
- в съответствие с EN 60669-1

COVER PLATE LINE 2x2M

- decorative cover plate LINE 2x2M
- horizontal or vertical mounting
- in accordance with EN 60669-1

ПАНЕЛ LINE 3x2M

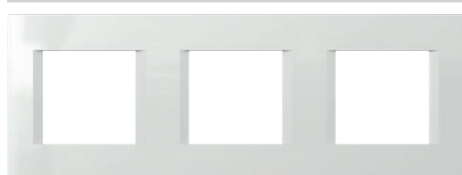

	OL26PW		OL26SG
	OL26MW		OL26NB
	OL26IW		OL26IB
	OL26ES		OL26AT
	OL26SB		OL26TI
			OL26SW

- декоративен панел LINE 3x2M
- хоризонтален или вертикален монтаж
- в съответствие с EN 60669-1

COVER PLATE LINE 3x2M

- decorative cover plate LINE 3x2M
- horizontal or vertical mounting
- in accordance with EN 60669-1

ПАНЕЛ LINE 4x2M



	OL28PW		OL28SG
	OL28MW		OL28NB
	OL28IW		OL28IB
	OL28ES		OL28AT
	OL28SB		OL28TI
			OL28SW

- декоративен панел LINE 4x2M
- хоризонтален или вертикален монтаж
- в съответствие с EN 60669-1

COVER PLATE LINE 4x2M

- decorative cover plate LINE 4x2M
- horizontal or vertical mounting
- in accordance with EN 60669-1

ПАНЕЛ LINE 5x2M

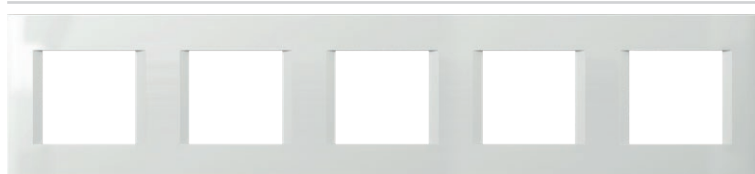

	OL29PW
	OL29MW
	OL29IW
	OL29ES
	OL29SB
	OL29AT
	OL29TI

- декоративен панел LINE 5x2M
- хоризонтален или вертикален монтаж
- в съответствие с EN 60669-1

COVER PLATE LINE 5x2M

- decorative cover plate LINE 5x2M
- horizontal or vertical mounting
- in accordance with EN 60669-1

COVER PLATES LINE OL

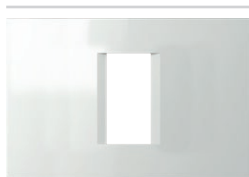

	OL13PW		OL13SG
	OL13MW		OL13NB
	OL13IW		OL13IB
	OL13ES		OL13AT
	OL13SB		OL13TI
			OL13SW

ПАНЕЛ LINE 1/3M

- декоративен панел LINE 1/3M
- в съответствие с EN 60669-1

COVER PLATE LINE 1/3M

- decorative cover plate LINE 1/3M
- in accordance with EN 60669-1

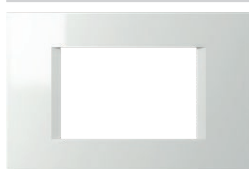

	OL30PW		OL30SG
	OL30MW		OL30NB
	OL30IW		OL30IB
	OL30ES		OL30AT
	OL30SB		OL30TI
			OL30SW

ПАНЕЛ LINE 3M

- декоративен панел LINE 3M
- в съответствие с EN 60669-1

COVER PLATE LINE 3M

- decorative cover plate LINE 3M
- in accordance with EN 60669-1



	OL40PW		OL40SG
	OL40MW		OL40NB
	OL40IW		OL40IB
	OL40ES		OL40AT
	OL40SB		OL40TI
			OL40SW

ПАНЕЛ LINE 4M

- декоративен панел LINE 4M
- в съответствие с EN 60669-1

COVER PLATE LINE 4M

- decorative cover plate LINE 4M
- in accordance with EN 60669-1

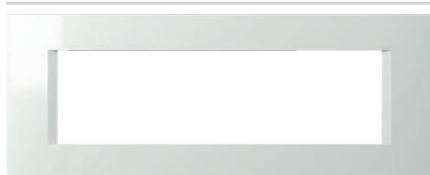

	OL70PW		OL70SG
	OL70MW		OL70NB
	OL70IW		OL70IB
	OL70ES		OL70AT
	OL70SB		OL70TI
			OL70SW

ПАНЕЛ LINE 7M

- декоративен панел LINE 7M
- в съответствие с EN 60669-1

COVER PLATE LINE 7M

- decorative cover plate LINE 7M
- in accordance with EN 60669-1



	OL71PW		OL71AT
	OL71MW		OL71TI
	OL71IW		
	OL71ES		
	OL71SB		

ПАНЕЛ LINE 2x7M

- декоративен панел LINE 2x7M
- в съответствие с EN 60669-1

COVER PLATE LINE 2x7M

- decorative cover plate LINE 2x7M
- in accordance with EN 60669-1

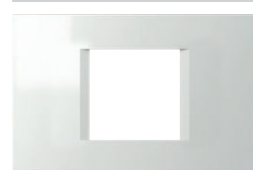

	OL23PW		OL23SG
	OL23MW		OL23NB
	OL23IW		OL23IB
	OL23ES		OL23AT
	OL23SB		OL23TI
			OL23SW

ПАНЕЛ LINE 2/3M

- декоративен панел LINE 2/3M
- в съответствие с EN 60669-1

COVER PLATE LINE 2/3M

- decorative cover plate LINE 2/3M
- in accordance with EN 60669-1

базов
basic

PW снежнобял цвят
polar white

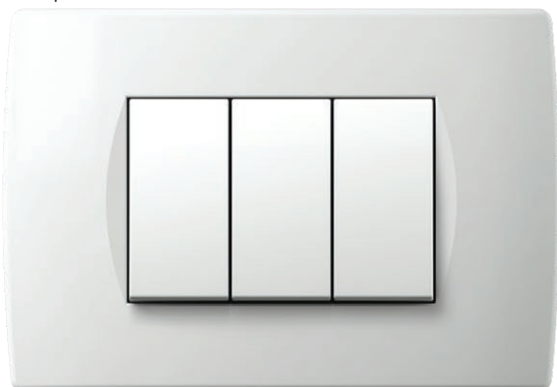

IW слонова кост
ivory white

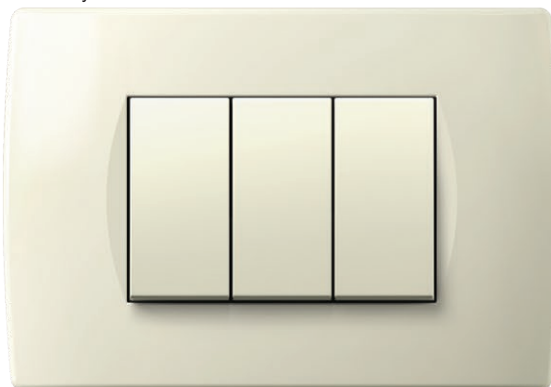

ES сребрист цвят с анодизирано покритие
elox silver

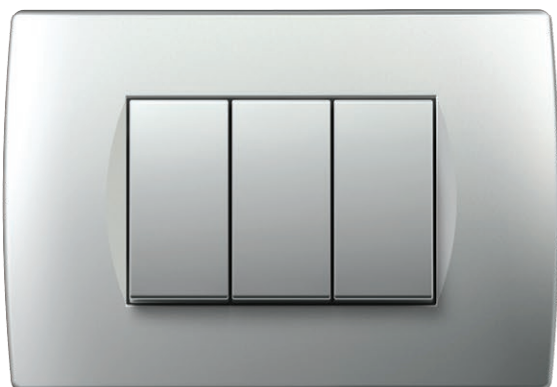

SB сензорен бутон, черен
soft touch black

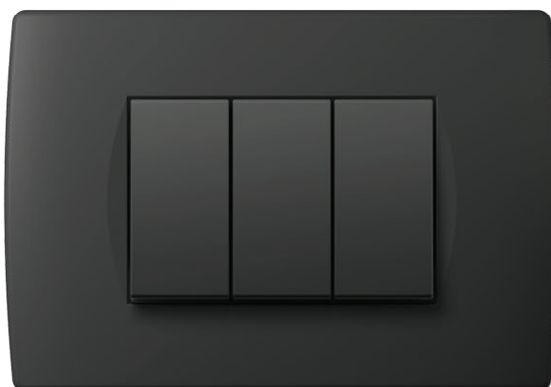

AT антрацит
anthracite



MW Бял матов цвят
matte white

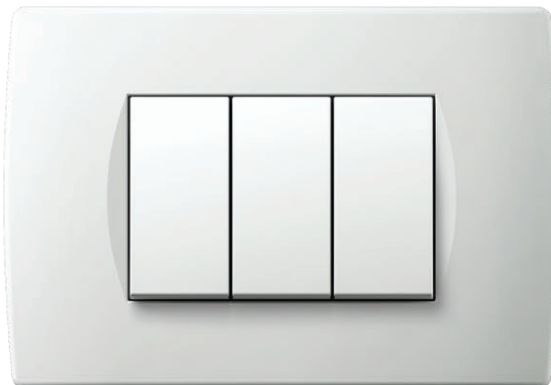

COVER PLATES SOFT OS

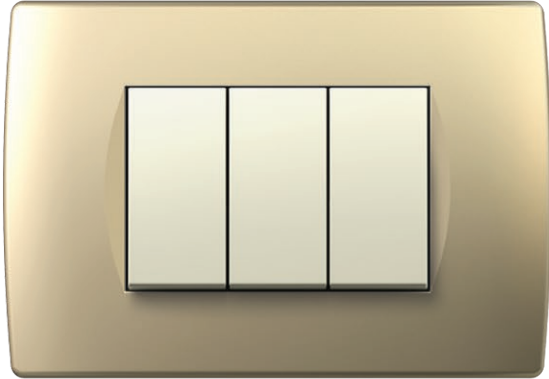
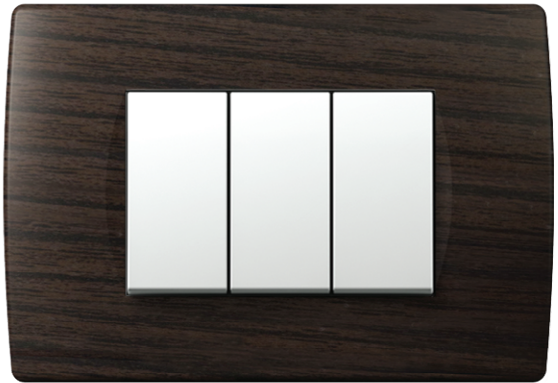
декор
decorSG пясъчнозлатист
sand goldNB тъмночерен
night blackTI титан
titaniumWE венге
wengeWW орех
walnut



OS30



PW

тип type	описание description	размер size	цвет colour																																													
OS10	ПАНЕЛ SOFT COVER PLATE SOFT	1/2M	<table border="0"> <tr> <td></td> <td>PW</td> <td>снежнобял цвят polar white</td> <td></td> <td>SG</td> <td>пясъчнозлатист sand gold</td> <td></td> <td>WW</td> <td>орех walnut</td> </tr> <tr> <td></td> <td>MW</td> <td>Бял матов цвят matte white</td> <td></td> <td>NB</td> <td>тъмночерен night black</td> <td></td> <td>WE</td> <td>венге wenge</td> </tr> <tr> <td></td> <td>IW</td> <td>слонова кост ivory white</td> <td></td> <td>AT</td> <td>антрацит anthracite</td> <td></td> <td></td> <td></td> </tr> <tr> <td></td> <td>ES</td> <td>сребрист цвят с eloxirano покритие</td> <td></td> <td>TI</td> <td>титан titanium</td> <td></td> <td></td> <td></td> </tr> <tr> <td></td> <td>SB</td> <td>soft touch black черен</td> <td></td> <td></td> <td></td> <td></td> <td></td> <td></td> </tr> </table>		PW	снежнобял цвят polar white		SG	пясъчнозлатист sand gold		WW	орех walnut		MW	Бял матов цвят matte white		NB	тъмночерен night black		WE	венге wenge		IW	слонова кост ivory white		AT	антрацит anthracite					ES	сребрист цвят с eloxirano покритие		TI	титан titanium					SB	soft touch black черен						
	PW	снежнобял цвят polar white		SG	пясъчнозлатист sand gold		WW	орех walnut																																								
	MW	Бял матов цвят matte white		NB	тъмночерен night black		WE	венге wenge																																								
	IW	слонова кост ivory white		AT	антрацит anthracite																																											
	ES	сребрист цвят с eloxirano покритие		TI	титан titanium																																											
	SB	soft touch black черен																																														
OS13	ПАНЕЛ SOFT COVER PLATE SOFT	1/3M																																														
OS20	ПАНЕЛ SOFT COVER PLATE SOFT	2M																																														
.	.	.	.																																													
.	.	.	.																																													



ПАНЕЛ SOFT 1/2M



	OS10PW		OS10SG
	OS10MW		OS10NB
	OS10IW		OS10AT
	OS10ES		OS10TI
	OS10SB		OS10WW
			OS10WE

- декоративен панел SOFT 1/2M
- в съответствие с EN 60669-1

COVER PLATE SOFT 1/2M

- decorative cover plate SOFT 1/2M
- in accordance with EN 60669-1

ПАНЕЛ SOFT 2M



	OS20PW		OS20SG
	OS20MW		OS20NB
	OS20IW		OS20AT
	OS20ES		OS20TI
	OS20SB		OS20WW
			OS20WE

- декоративен панел SOFT 2M
- в съответствие с EN 60669-1

COVER PLATE SOFT 2M

- decorative cover plate SOFT 2M
- in accordance with EN 60669-1

ПАНЕЛ SOFT 2x2M



	OS24PW		OS24SG
	OS24MW		OS24NB
	OS24IW		OS24AT
	OS24ES		OS24TI
	OS24SB		OS24WW
			OS24WE

- декоративен панел SOFT 2x2M
- хоризонтален или вертикален монтаж
- в съответствие с EN 60669-1

COVER PLATE SOFT 2x2M

- decorative cover plate SOFT 2x2M
- horizontal or vertical mounting
- in accordance with EN 60669-1

ПАНЕЛ SOFT 3x2M



	OS26PW		OS26SG
	OS26MW		OS26NB
	OS26IW		OS26AT
	OS26ES		OS26TI
	OS26SB		OS26WW
			OS26WE

- декоративен панел SOFT 3x2M
- хоризонтален или вертикален монтаж
- в съответствие с EN 60669-1

COVER PLATE SOFT 3x2M

- decorative cover plate
SOFT 3x2M
- horizontal or vertical mounting
- in accordance with EN 60669-1

ПАНЕЛ SOFT 4x2M



	OS28PW		OS28SG
	OS28MW		OS28NB
	OS28IW		OS28AT
	OS28ES		OS28TI
	OS28SB		OS28WW
			OS28WE



- декоративен панел SOFT 4x2M
- хоризонтален или вертикален монтаж
- в съответствие с EN 60669-1

COVER PLATE SOFT 4x2M

- decorative cover plate
SOFT 4x2M
- horizontal or vertical mounting
- in accordance with EN 60669-1

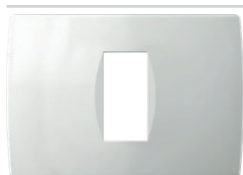
COVER PLATES SOFT OS



 OS13PW	 OS13SG
 OS13MW	 OS13NB
 OS13IW	 OS13AT
 OS13ES	 OS13TI
 OS13SB	 OS13WW
	 OS13WE

ПАНЕЛ SOFT 1/3M

- декоративен панел SOFT 1/3M
- в съответствие с EN 60669-1

COVER PLATE SOFT 1/3M

- decorative cover plate SOFT 1/3M
- in accordance with EN 60669-1

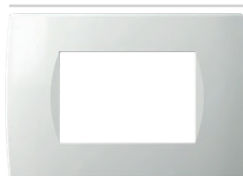

 OS30PW	 OS30SG
 OS30MW	 OS30NB
 OS30IW	 OS30AT
 OS30ES	 OS30TI
 OS30SB	 OS30WW
	 OS30WE











ПАНЕЛ SOFT 3M

- декоративен панел SOFT 3M
- в съответствие с EN 60669-1

COVER PLATE SOFT 3M

- decorative cover plate SOFT 3M
- in accordance with EN 60669-1



 OS40PW	 OS40SG
 OS40MW	 OS40NB
 OS40IW	 OS40AT
 OS40ES	 OS40TI
 OS40SB	 OS40WW
	 OS40WE

ПАНЕЛ SOFT 4M

- декоративен панел SOFT 4M
- в съответствие с EN 60669-1

COVER PLATE SOFT 4M

- decorative cover plate SOFT 4M
- in accordance with EN 60669-1



 OS70PW	 OS70SG
 OS70MW	 OS70NB
 OS70IW	 OS70AT
 OS70ES	 OS70TI
 OS70SB	 OS70WW
	 OS70WE







ПАНЕЛ SOFT 7M

- декоративен панел SOFT 7M
- в съответствие с EN 60669-1

COVER PLATE SOFT 7M

- decorative cover plate SOFT 7M
- in accordance with EN 60669-1



 OS71PW	 OS71AT
 OS71MW	 OS71TI
 OS71IW	
 OS71ES	
 OS71SB	







ПАНЕЛ SOFT 2x7M

- декоративен панел SOFT 2x7M
- в съответствие с EN 60669-1

COVER PLATE SOFT 2x7M

- decorative cover plate SOFT 2x7M
- in accordance with EN 60669-1



 OS72PW	 OS72SG
 OS72IW	 OS72AT
 OS72ES	 OS72TI
 OS72SB	

ПАНЕЛ SOFT 2x7M

- декоративен панел SOFT 2x7M
панел с надпис
- в съответствие с EN 60669-1

COVER PLATE SOFT 2x7M

- decorative cover plate SOFT 2x7M
with inscription plate
- in accordance with EN 60669-1

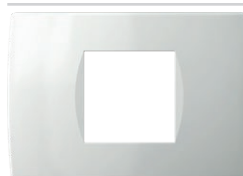

 OS23PW	 OS23SG
 OS23MW	 OS23NB
 OS23IW	 OS23AT
 OS23ES	 OS23TI
 OS23SB	 OS23WW
	 OS23WE

ПАНЕЛ SOFT 2/3M

- декоративен панел SOFT 2/3M
- в съответствие с EN 60669-1

COVER PLATE SOFT 2/3M

- decorative cover plate SOFT 2/3M
- in accordance with EN 60669-1

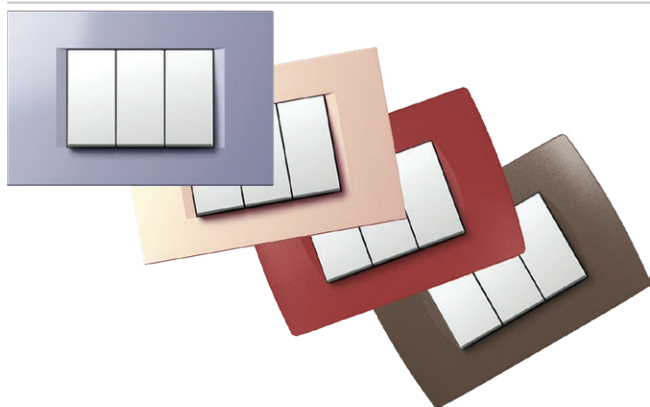

ДЕКОРИРАНЕ НА ПАНЕЛИ

- когато поръчвате големи количества, декоративните панели могат да бъдат изработени в изборния от вас цвят
- подходящо за панели OL, OS

COVER PLATES DECORATIONS

- when ordering large quantities, cover plates can be made in the colour of your choice
- suitable for cover plates OL, OS

ДЪРВО
wood

WB бамбук
bamboo



WW орех
walnut



WM клен
maple



WE венге
wenge



Природата е уникална и прецизна, и сред нашите декоративни панели няма два еднакви.
Рекламации във връзка с разнообразния външен вид на дървени декоративни панели и различия не се приемат.

Nature is unique and precious, as our decorative cover plates where no two are the same.
Complaints about wooden decorative cover plate's diverse appearance and differentiation cannot be considered.

C O V E R P L A T E S P U R E O P

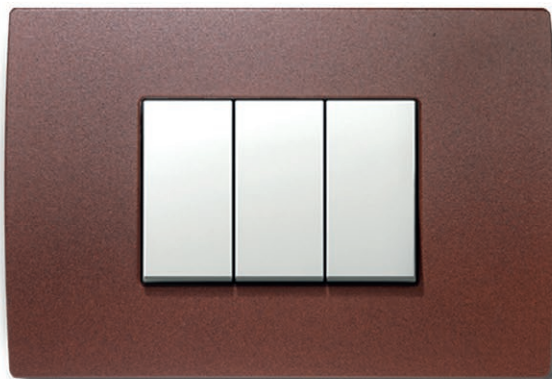
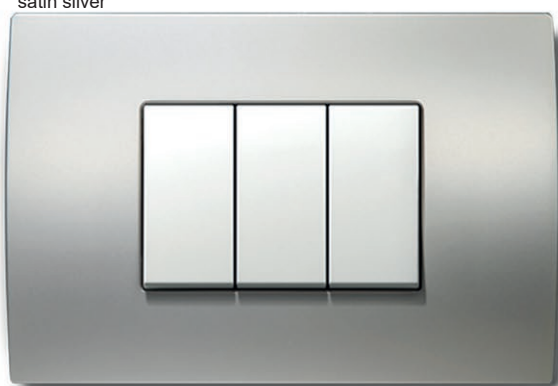
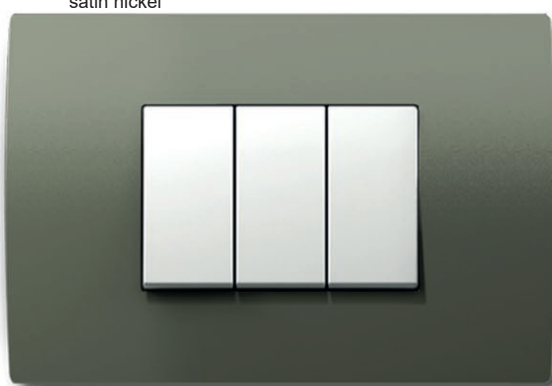
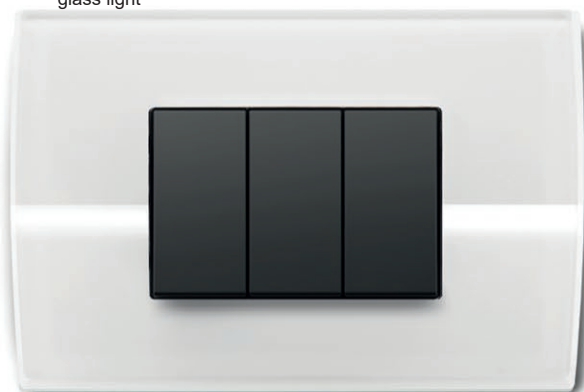
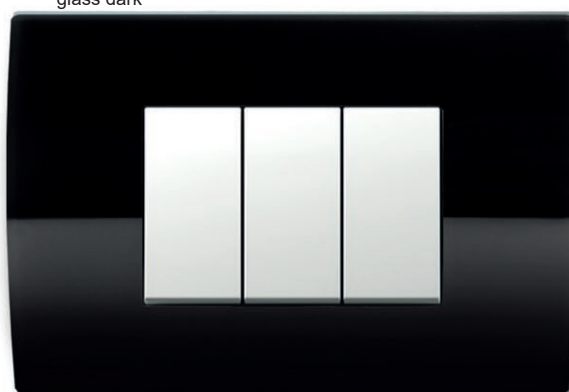
МЕТАЛ
metalMH ковано желязо
hammered steelME ецвано желязо
etched ironMS матов сребрист цвят
satin silverMN матов никел
satin nickelСТЪКЛО
glassGL бяло
glass lightGD черно
glass dark



тип type	описание description	размер size	цвет colour
OP13	ПАНЕЛ PURE COVER PLATE PURE	1/3M	MH ковано желязо hammered steel
OP20	ПАНЕЛ PURE COVER PLATE PURE	2M	ME ецвано желязо etched iron
OP23	ПАНЕЛ PURE COVER PLATE PURE	2/3M	MS матов сребрист цвет satin silver
·	·	·	MN матов никел satin nickel
·	·	·	WB бамбук bamboo
·	·	·	WW орех walnut
·	·	·	WM клен maple
·	·	·	WE венге wenge
·	·	·	GL бяло glass light
·	·	·	GD черно glass dark



MH	OP20MH	WB	OP20WB
ME	OP20ME	WW	OP20WW
MS	OP20MS	WM	OP20WM
MN	OP20MN	WE	OP20WE
		GL	OP20GL
		GD	OP20GD

ПАНЕЛ PURE 2M

- декоративен панел PURE 2M
- в съответствие с EN 60669-1
- само в комбинация с монтажна рамка NM24 или NM25

COVER PLATE PURE 2M

- decorative cover plate PURE 2M
- in accordance with EN 60669-1

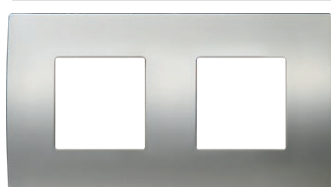

MH	OP24MH	WB	OP24WB
ME	OP24ME	WW	OP24WW
MS	OP24MS	WM	OP24WM
MN	OP24MN	WE	OP24WE
		GL	OP24GL
		GD	OP24GD

ПАНЕЛ PURE 2x2M

- декоративен панел PURE 2x2M
- хоризонтален или вертикален монтаж
- в съответствие с EN 60669-1
- само в комбинация с монтажна рамка NM24 или NM25

COVER PLATE PURE 2x2M

- decorative cover plate PURE 2x2M
- horizontal or vertical mounting
- in accordance with EN 60669-1

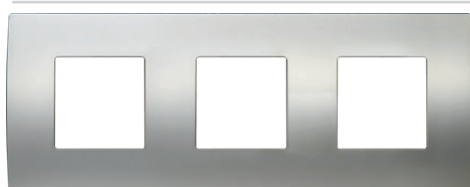

MH	OP26MH	WB	OP26WB
ME	OP26ME	WW	OP26WW
MS	OP26MS	WM	OP26WM
MN	OP26MN	WE	OP26WE
		GL	OP26GL
		GD	OP26GD

ПАНЕЛ PURE 3x2M

- декоративен панел PURE 3x2M
- хоризонтален или вертикален монтаж
- в съответствие с EN 60669-1
- само в комбинация с монтажна рамка NM24 или NM25

COVER PLATE PURE 3x2M

- decorative cover plate PURE 3x2M
- horizontal or vertical mounting
- in accordance with EN 60669-1



MH	OP28MH	WB	OP28WB
ME	OP28ME	WW	OP28WW
MS	OP28MS	WM	OP28WM
MN	OP28MN	WE	OP28WE
		GL	OP28GL
		GD	OP28GD

ПАНЕЛ PURE 4x2M

- декоративен панел PURE 4x2M
- хоризонтален или вертикален монтаж
- в съответствие с EN 60669-1
- само в комбинация с монтажна рамка NM24 или NM25

COVER PLATE PURE 4x2M

- decorative cover plate PURE 4x2M
- horizontal or vertical mounting
- in accordance with EN 60669-1

COVER PLATES PURE OP

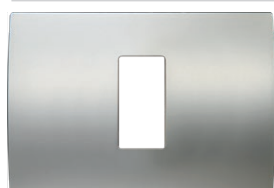

	OP13MH		OP13WB
	OP13ME		OP13WW
	OP13MS		OP13WM
	OP13MN		OP13WE
			OP13GL
			OP13GD

ПАНЕЛ PURE 1/3M

- декоративен панел PURE 1/3M
- в съответствие с EN 60669-1

COVER PLATE PURE 1/3M

- decorative cover plate PURE 1/3M
- in accordance with EN 60669-1



	OP30MH		OP30WB
	OP30ME		OP30WW
	OP30MS		OP30WM
	OP30MN		OP30WE
			OP30GL
			OP30GD

ПАНЕЛ PURE 3M

- декоративен панел PURE 3M
- в съответствие с EN 60669-1

COVER PLATE PURE 3M

- decorative cover plate PURE 3M
- in accordance with EN 60669-1

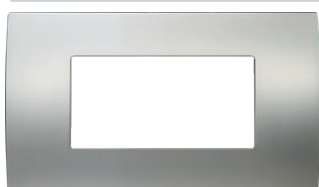

	OP40MH		OP40WB
	OP40ME		OP40WW
	OP40MS		OP40WM
	OP40MN		OP40WE
			OP40GL
			OP40GD

ПАНЕЛ PURE 4M

- декоративен панел PURE 4M
- в съответствие с EN 60669-1

COVER PLATE PURE 4M

- decorative cover plate PURE 4M
- in accordance with EN 60669-1

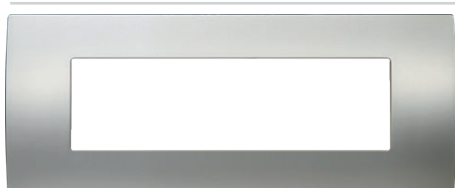

	OP70MH		OP70WB
	OP70ME		OP70WW
	OP70MS		OP70WM
	OP70MN		OP70WE
			OP70GL
			OP70GD

ПАНЕЛ PURE 7M

- декоративен панел PURE 7M
- в съответствие с EN 60669-1

COVER PLATE PURE 7M

- decorative cover plate PURE 7M
- in accordance with EN 60669-1

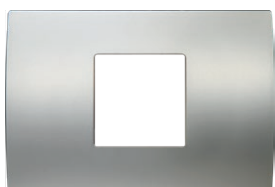

	OP23MH		OP23WB
	OP23ME		OP23WW
	OP23MS		OP23WM
	OP23MN		OP23WE
			OP23GL
			OP23GD

ПАНЕЛ PURE 2/3M

- декоративен панел PURE 2/3M
- в съответствие с EN 60669-1

COVER PLATE PURE 2/3M

- decorative cover plate PURE 2/3M
- in accordance with EN 60669-1

Be bold, be EDGE

C O V E R P L A T E S E D G E O G

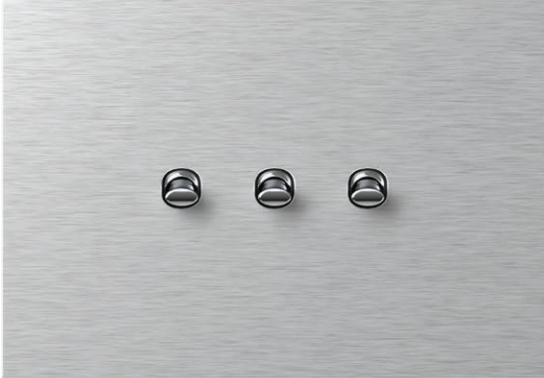
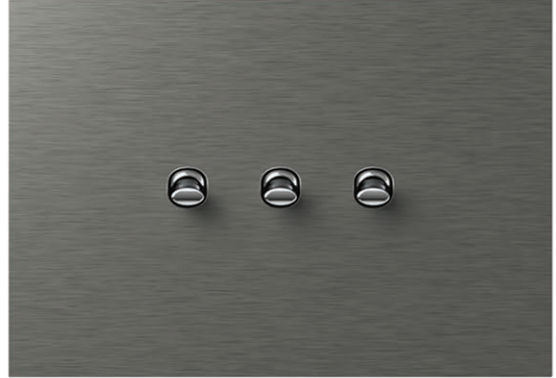
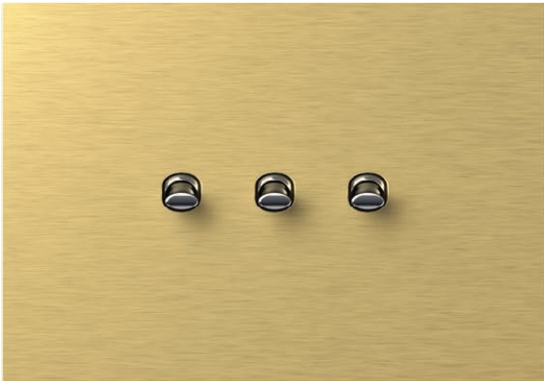
Метал
metalMA Сребърна
silverMT Антрацитна
anthraciteMZ Златна
gold**СЪКЛО**
glassGD Черна
glass darkGL Бяла
glass light

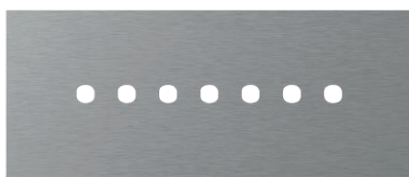
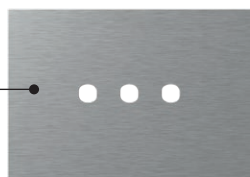

OG30

MA

P

Тип type	Наименование description	Размер size	Цвят colour
OG10	PAMKA EDGE COVER PLATE EDGE	1/2M	MA Сребърна silver GD Черна glass dark
OG13	PAMKA EDGE COVER PLATE EDGE	1/3M	MT Антрацитна anthracite GL Бяла glass light
OG20	PAMKA EDGE COVER PLATE EDGE	2M	MZ Златна gold
⋮	⋮	⋮	

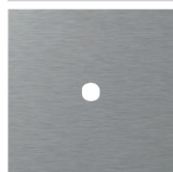
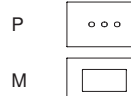

- OG10MAP
- OG10GDP
- OG10MTP
- OG10GLP
- OG10MZP

PAMKA EDGE 1/2M

- декоративна рамка EDGE 1/2M
- съответства на EN 60669-1

COVER PLATE EDGE 1/2M
- decorative cover plate EDGE 1/2M
- in accordance with EN 60669-1

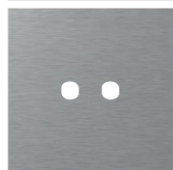

- OG20MAP
- OG20GDP
- OG20MTP
- OG20GLP
- OG20MZP

PAMKA EDGE 2M

- декоративна рамка EDGE 2M
- съответства на EN 60669-1

COVER PLATE EDGE 2M
- decorative cover plate EDGE 2M
- in accordance with EN 60669-1

C O V E R P L A T E S E D G E O G

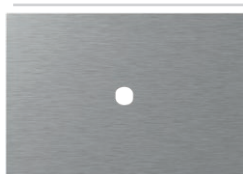

PAMKA EDGE 1/3M

– декоративна рамка EDGE 1/3M
– съответства на EN 60669-1

COVER PLATE EDGE 1/3M

- decorative cover plate EDGE 1/3M
- in accordance with EN 60669-1

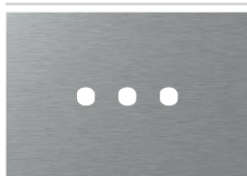

PAMKA EDGE 3M

– декоративна рамка EDGE 3M
– съответства на EN 60669-1

COVER PLATE EDGE 3M

- decorative cover plate EDGE 3M
- in accordance with EN 60669-1

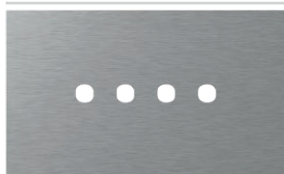

PAMKA EDGE 4M

– декоративна рамка EDGE 4M
– съответства на EN 60669-1

COVER PLATE EDGE 4M

- decorative cover plate EDGE 4M
- in accordance with EN 60669-1

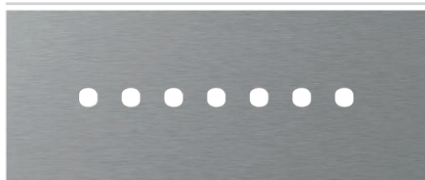

PAMKA EDGE 7M

– декоративна рамка EDGE 7M
– съответства на EN 60669-1

COVER PLATE EDGE 7M

- decorative cover plate EDGE 7M
- in accordance with EN 60669-1

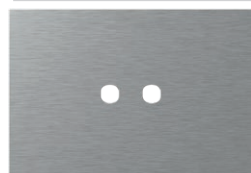

PAMKA EDGE 2/3M

– декоративна рамка EDGE 2/3M
– съответства на EN 60669-1

OKVIR EDGE 2/3M

– dekorativni okvir EDGE 2/3M
– usklađeno s normom EN 60669-1

Метал
metal

MA Сребърна
silver

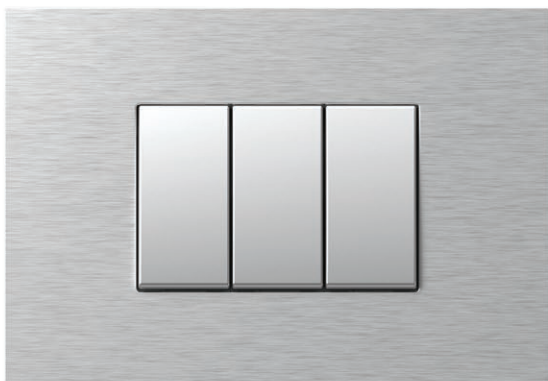

MT Антрацитна
anthracite



MZ Златна
gold

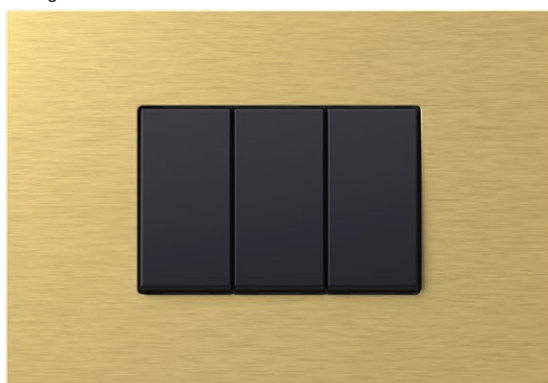

СЪКЛО
glass

GD Черна
glass dark

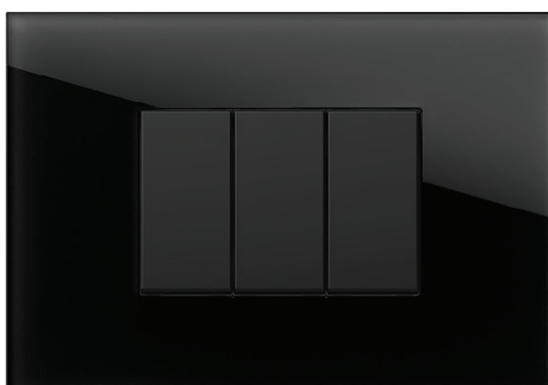

GL Бяла
glas light

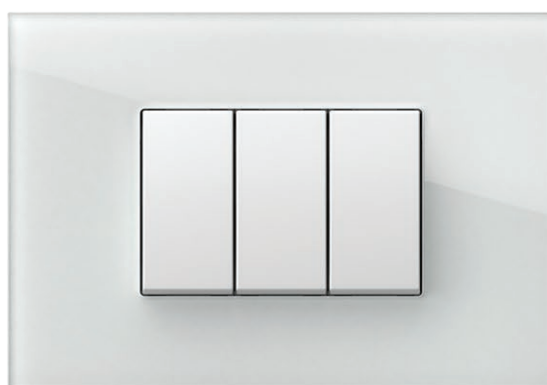

COVER PLATES EDGE O G



OG30

MA

M

Тип type	Наименование description	Размер size	Цвет colour
OG10	РАМКА EDGE COVER PLATE EDGE	1/2M	MA Сребърна silver GD Черна glass dark GL Бяла glass light
OG13	РАМКА EDGE COVER PLATE EDGE	1/3M	MT Антрацитна anthracite GL Бяла glass light
OG20	РАМКА EDGE COVER PLATE EDGE	2M	MZ Златна gold GD Черна glass dark GL Бяла glass light
...

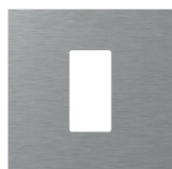
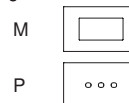

OG10MAM
 OG10MTM
 OG10MZM
 OG10GDM
 OG10GLM

РАМКА EDGE 1/2M

– декоративна рамка EDGE 1/2M
– съответства на EN 60669-1

COVER PLATE EDGE 1/2M

– decorative cover plate EDGE 1/2M
– in accordance with EN 60669-1

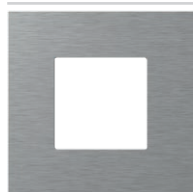

OG20MAM
 OG20MTM
 OG20MZM
 OG20GDM
 OG20GLM

РАМКА EDGE 2M

– декоративна рамка EDGE 2M
– съответства на EN 60669-1

COVER PLATE EDGE 2M

– decorative cover plate EDGE 2M
– in accordance with EN 60669-1



OG24MAM
 OG24MTM
 OG24MZM
 OG24GDM
 OG24GLM

РАМКА EDGE 2x2M

– декоративна рамка EDGE 2x2M
– хоризонтално или вертикално вграждане
– съответства на EN 60669-1

COVER PLATE EDGE 2x2M

– decorative cover plate EDGE 2x2M
– horizontal or vertical mounting
– in accordance with EN 60669-1

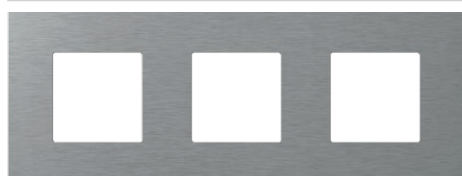

OG26MAM
 OG26MTM
 OG26MZM
 OG26GDM
 OG26GLM

РАМКА EDGE 3x2M

– декоративна рамка EDGE 3x2M
– хоризонтално или вертикално вграждане
– съответства на EN 60669-1

COVER PLATE EDGE 3x2M

– decorative cover plate EDGE 3x2M
– horizontal or vertical mounting
– in accordance with EN 60669-1

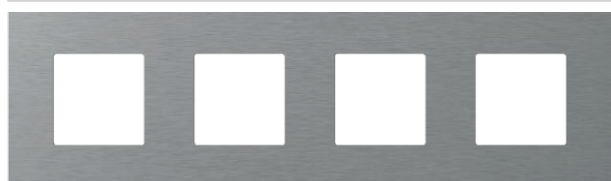

OG28MAM
 OG28MTM
 OG28MZM
 OG28GDM
 OG28GLM





РАМКА EDGE 4x2M

– декоративна рамка EDGE 4x2M
– хоризонтално или вертикално вграждане
– съответства на EN 60669-1

COVER PLATE EDGE 4x2M

– decorative cover plate EDGE 4x2M
– horizontal or vertical mounting
– in accordance with EN 60669-1







 OG13MAM	 OG13GDM
 OG13MTM	 OG13GLM
 OG13MZM	

PAMKA EDGE 1/3M

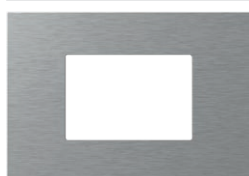
– декоративна рамка EDGE 1/3M
– съответства на EN 60669-1

COVER PLATE EDGE 1/3M
- decorative cover plate EDGE 1/3M
- in accordance with EN 60669-1





 OG30MAM	 OG30GDM
 OG30MTM	 OG30GLM
 OG30MZM	

PAMKA EDGE 3M

– декоративна рамка EDGE 3M
– съответства на EN 60669-1

COVER PLATE EDGE 3M
- decorative cover plate EDGE 3M
- in accordance with EN 60669-1



 OG40MAM	 OG40GDM
 OG40MTM	 OG40GLM
 OG40MZM	

PAMKA EDGE 4M

– декоративна рамка EDGE 4M
– съответства на EN 60669-1

COVER PLATE EDGE 4M
- decorative cover plate EDGE 4M
- in accordance with EN 60669-1



 OG70MAM	 OG70GDM
 OG70MTM	 OG70GLM
 OG70MZM	

PAMKA EDGE 7M

– декоративна рамка EDGE 7M
– съответства на EN 60669-1

COVER PLATE EDGE 7M
- decorative cover plate EDGE 7M
- in accordance with EN 60669-1

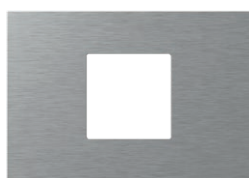

 OG23MAM	 OG23GDM
 OG23MTM	 OG23GLM
 OG23MZM	

PAMKA EDGE 2/3M

– декоративна рамка EDGE 2/3M
– съответства на EN 60669-1

COVER PLATE EDGE 2/3M
- decorative cover plate EDGE 2/3M
- in accordance with EN 60669-1



MODUL
LINE

A x B



MODUL
SOFT

A x B



MODUL
PURE

A x B

1/2M

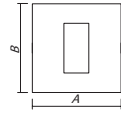

80 x 80 mm

84 x 84 mm

2M

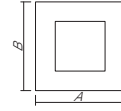

80 x 80 mm

84 x 84 mm

93 x 90 mm

2x2M

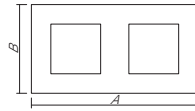

151 x 80 mm

155 x 84 mm

164 x 90 mm

3x2M

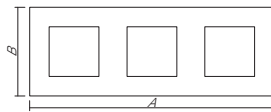

222 x 80 mm

226 x 84 mm

235 x 90 mm

4x2M

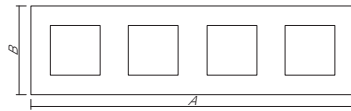

293 x 80 mm

297 x 84 mm

304 x 90 mm

5x2M

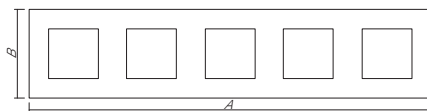

364,1 x 80 mm



1/3M

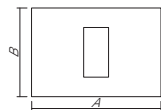

122 x 80 mm

122 x 84 mm

134 x 90 mm

3M

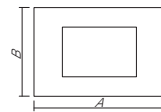

122 x 80 mm

122 x 84 mm

134 x 90 mm

4M

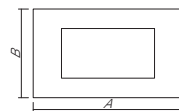

149 x 80 mm

144 x 84 mm

157 x 90 mm

7M

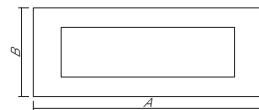

207 x 80 mm

212 x 84 mm

224 x 90 mm

2x7M

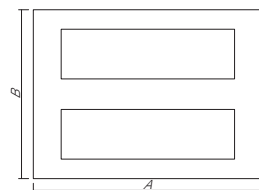

215 x 159 mm

212 x 158 mm



2/3M

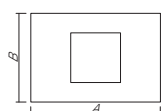

122 x 80 mm

122 x 84 mm

134 x 90 mm



MODUL

EDGE

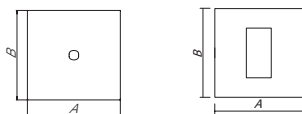

1/2M

 $A \times B$ 92 x 92
mm

2M

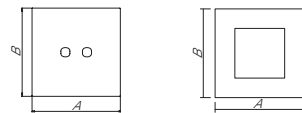
92 x 92
mm

2x2M

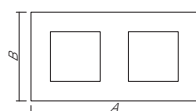
163 x 92
mm

3x2M

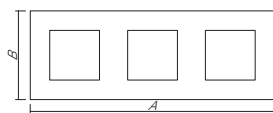
234 x 92
mm

4x2M

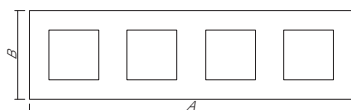
305 x 92
mm

1/3M

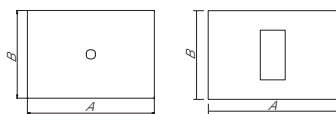
132 x 92
mm

3M

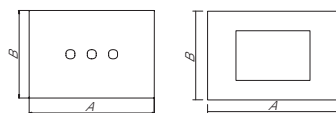
132 x 92
mm

4M

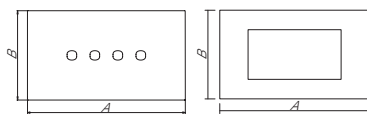
154 x 92
mm

7M

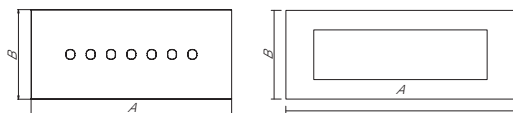
222 x 92
mm

2/3M

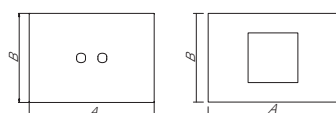
132 x 92
mm

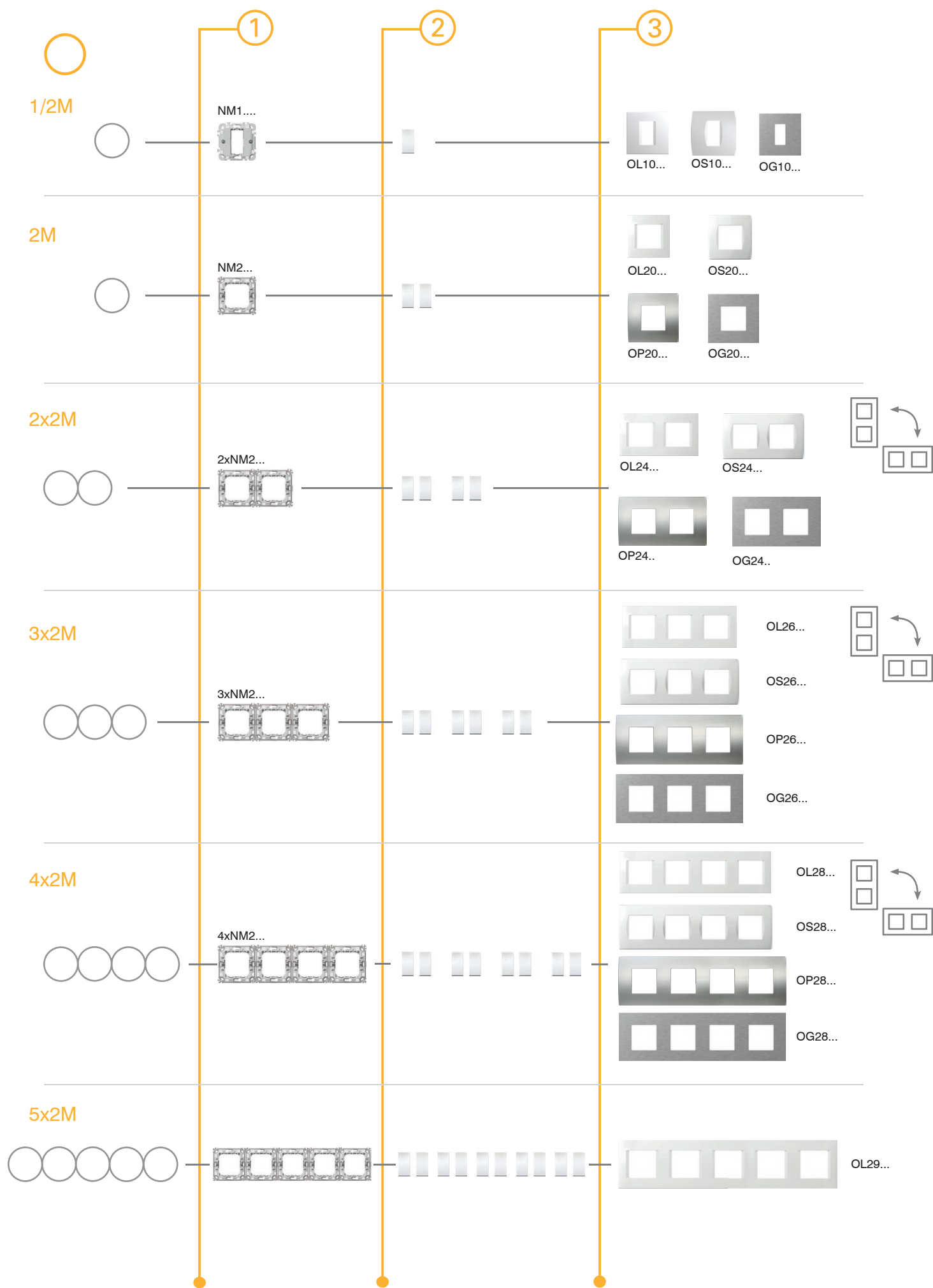

C O M B I N A T I O N S

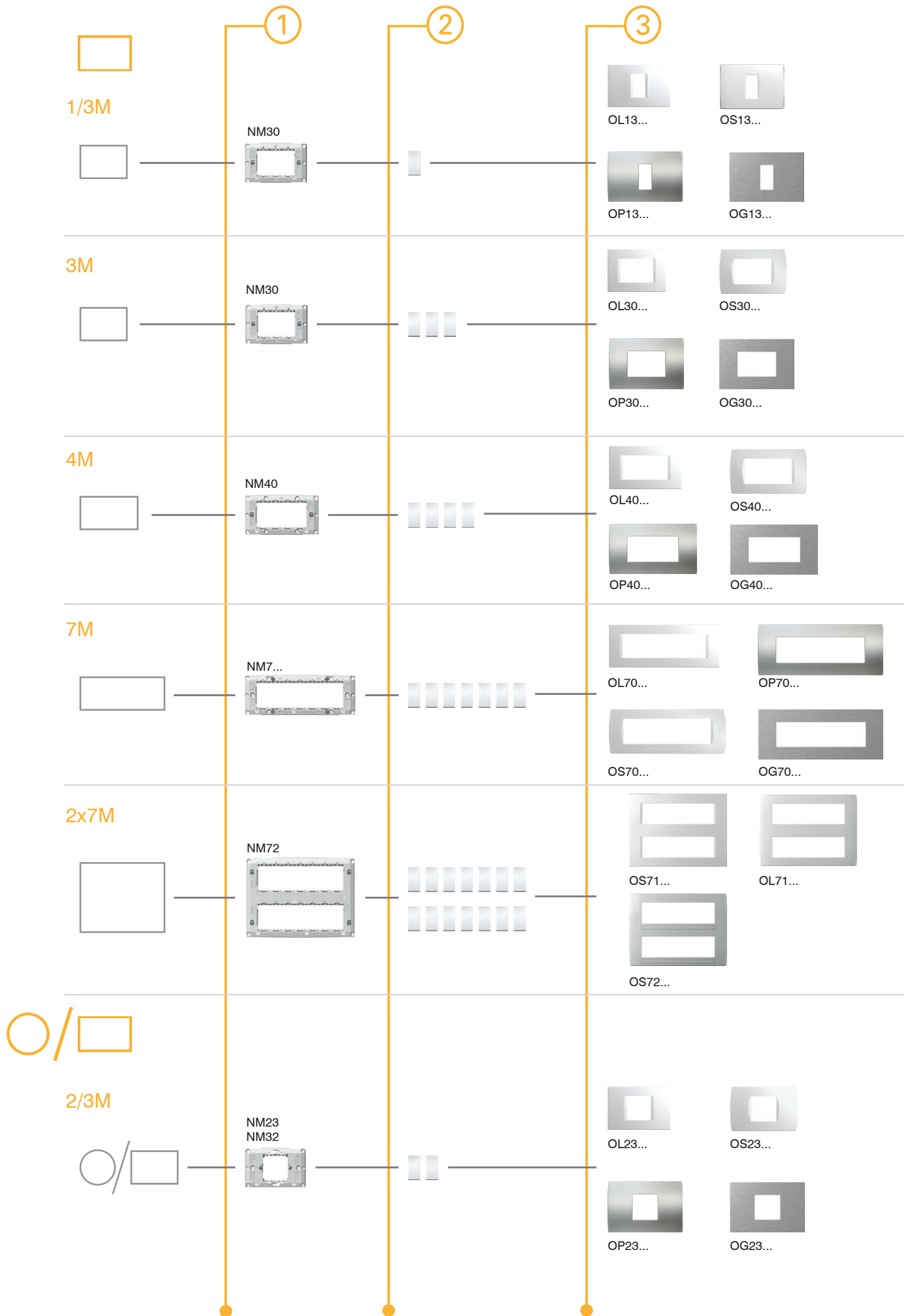

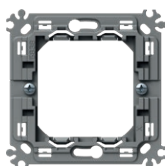

NM30

тип type	описание description	размер size
NM10	МОНТАЖНА РАМКА С ЩИПКИ MOUNTING FRAME WITH CLAWS	1/2M
NM11	МОНТАЖНА РАМКА БЕЗ ВИНТОВЕ MOUNTING FRAME WITHOUT SCREWS	1/2M
NM20	МОНТАЖНА РАМКА С ЩИПКИ MOUNTING FRAME WITH CLAWS	2M
⋮	⋮	⋮
⋮	⋮	⋮



МОНТАЖНА РАМКА С ЩИПКИ 1/2M

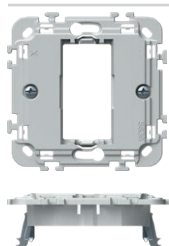

NM10

- монтажна рамка 1/2M с крачета
- за монтаж на конзоли Ø60 (DE.) с крачета
- подходяща за сглобяване с панели LINE, SOFT и EDGE
- в съответствие с EN 60669-1

MOUNTING FRAME WITH CLAWS 1/2M

- mounting frame 1/2M with claws
- for mounting on boxes Ø60 (DE..) with claws
- suitable for assembling with cover plates LINE, SOFT and EDGE
- in accordance with EN 60669-1

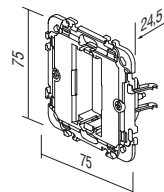

МОНТАЖНА РАМКА БЕЗ ВИНТОВЕ 1/2M

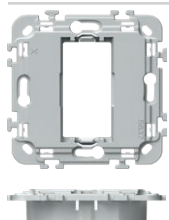

NM11

- монтажна рамка 1/2M без винтове и без крачета
- за монтаж на конзоли Ø60 (HE., BE.) с винтове
- подходяща за сглобяване с панели LINE, SOFT и EDGE
- в съответствие с EN 60669-1

MOUNTING FRAME WITHOUT SCREWS 1/2M

- mounting frame 1/2M without screws and without claws
- for mounting on boxes Ø60 (HE., BE..) with screws
- suitable for assembling with cover plates LINE, SOFT and EDGE
- in accordance with EN 60669-1

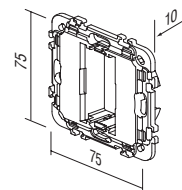

МОНТАЖНА РАМКА С ЩИПКИ 2M

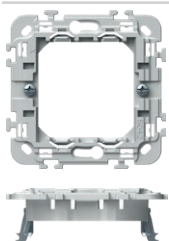

NM20

- монтажна рамка 2M с крачета
- за монтаж на конзоли Ø60 (DE.) с крачета
- възможни са хоризонтални или вертикални комбинации 2x2M, 3x2M и 4x2M
- подходяща за сглобяване с панели LINE, SOFT, PURE и EDGE
- в съответствие с EN 60669-1

MOUNTING FRAME WITH CLAWS 2M

- mounting frame 2M with claws
- for mounting on boxes Ø60 (DE..) with claws
- possible horizontal or vertical combinations 2x2M, 3x2M and 4x2M
- suitable for assembling with cover plates LINE, SOFT, PURE and EDGE
- in accordance with EN 60669-1

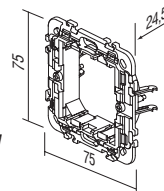

МОНТАЖНА РАМКА БЕЗ ВИНТОВЕ 2M

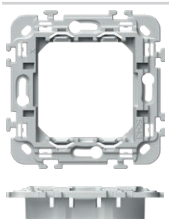

NM21

- монтажна рамка 2M без винтове и без крачета
- за монтаж на конзоли Ø60 (HE., BE.) с винтове
- възможни са хоризонтални или вертикални комбинации 2x2M, 3x2M и 4x2M
- подходяща за сглобяване с панели LINE, SOFT, PURE и EDGE
- в съответствие с EN 60669-1

MOUNTING FRAME WITHOUT SCREWS 2M

- mounting frame 2M without screws and without claws
- for mounting on boxes Ø60 (HE., BE..) with screws
- possible horizontal or vertical combinations 2x2M, 3x2M and 4x2M
- suitable for assembling with cover plates LINE, SOFT, PURE and EDGE
- in accordance with EN 60669-1

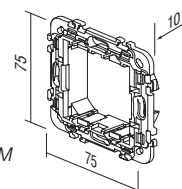

M O U N T I N G F R A M E S N M

МЕТАЛНА МОНТАЖНА РАМКА С ЩИПКИ 2М

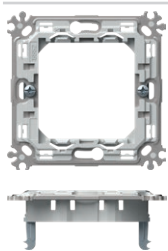

NM24

- метална монтажна рамка 2М с крачета – твърда версия
- за монтаж на конзоли Ø60 (DE.) с крачета
- възможни са хоризонтални или вертикални комбинации 2x2М, 3x2М и 4x2М
- подходяща за сглобяване с панели LINE, SOFT, PURE и EDGE
- в съответствие с EN 60669-1

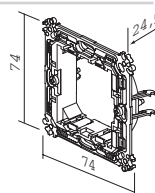

MOUNTING FRAME METAL WITH CLAWS 2M

- metal mounting frame 2M with claws - stiff version
- for mounting on boxes Ø60 (DE..) with claws
- possible horizontal or vertical combinations 2x2M, 3x2M and 4x2M
- suitable for assembling with cover plates LINE, SOFT, PURE and EDGE
- in accordance with EN 60669-1

МЕТАЛНА МОНТАЖНА РАМКА БЕЗ ВИНТОВЕ 2М

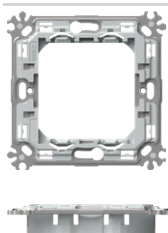

NM25

- метална монтажна рамка без винтове и без крачета – твърда версия
- за монтаж в конзоли Ø60 (HE..., BE...) с винтове
- възможни са хоризонтални или вертикални комбинации 2x2М, 3x2М и 4x2М
- подходяща за сглобяване с панели LINE, SOFT, PURE и EDGE
- в съответствие с EN 60669-1

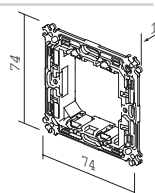

MOUNTING FRAME METAL WITHOUT SCREWS 2M

- metal mounting frame 2M without screws and without claws - stiff version
- for mounting in boxes Ø60 (HE..., BE...) with screws
- possible horizontal or vertical combinations 2x2M, 3x2M and 4x2M
- suitable for assembling with cover plates LINE, SOFT, PURE and EDGE
- in accordance with EN 60669-1

МОНТАЖНА РАМКА, УКРЕПЕНА С ЩИПКИ 2М

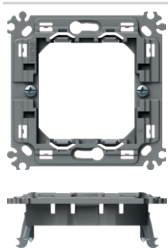

NM26

- укрепена монтажна рамка 2М с щипки – твърда версия
- за монтаж на конзоли Ø60 (DE.) с крачета
- възможни са хоризонтални или вертикални комбинации 2x2М, 3x2М и 4x2М
- подходяща за сглобяване с панели LINE, SOFT, PURE и EDGE
- в съответствие с EN 60669-1

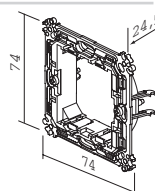

CLAW REINFORCED MOUNTING FRAME 2M

- 2M mounting frame reinforced with claws - stiff version
- for mounting on boxes Ø60 (DE..) with claws
- possible horizontal or vertical combinations 2x2M, 3x2M and 4x2M
- suitable for assembling with cover plates LINE, SOFT, PURE and EDGE
- in accordance with EN 60669-1

УКРЕПЕНА МОНТАЖНА РАМКА БЕЗ ВИНТОВЕ 2М

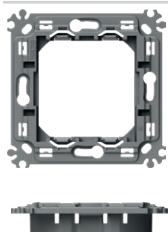

NM27

- укрепена монтажна рамка без винтове и щипки – твърда версия
- за монтаж в конзоли Ø60 (HE..., BE...) с винтове
- възможни са хоризонтални или вертикални комбинации 2x2М, 3x2М и 4x2М
- подходяща за сглобяване с панели LINE, SOFT, PURE и EDGE
- в съответствие с EN 60669-1

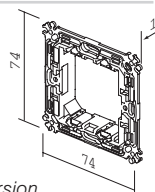

REINFORCED MOUNTING FRAME WITHOUT SCREWS 2M

- reinforced mounting frame without screws or claws - stiff version
- for mounting in boxes Ø60 (HE..., BE...) with screws
- possible horizontal or vertical combinations 2x2M, 3x2M and 4x2M
- suitable for assembling with cover plates LINE, SOFT, PURE and EDGE
- in accordance with EN 60669-1

МОНТАЖНА РАМКА С ЩИПКИ 2/3М

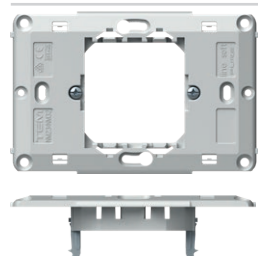

NM23

- монтажна рамка 2/3М с крачета
- за монтаж на конзоли Ø60 (DE.) с крачета
- подходяща за сглобяване с панели LINE, SOFT, PURE и EDGE
- в съответствие с EN 60669-1

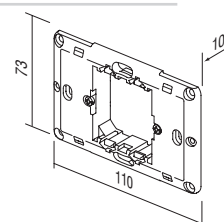

MOUNTING FRAME WITH CLAWS 2/3M

- mounting frame 2/3M with claws
- for mounting on boxes Ø60 (DE..) with claws
- suitable for assembling with cover plates LINE, SOFT, PURE and EDGE
- in accordance with EN 60669-1





МОНТАЖНА РАМКА С ВИНТОВЕ 3М

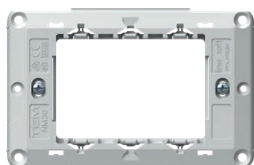

NM30

- монтажна рамка 3М с винтове
- за монтаж в правоъгълни конзоли 3М
- подходяща за сглобяване с панели LINE, SOFT, PURE и EDGE
- в съответствие с EN 60669-1

MOUNTING FRAME WITH SCREWS 3M

- mounting frame 3M with screws
- for mounting on rectangular boxes 3M
- suitable for assembling with cover plates LINE, SOFT, PURE and EDGE
- in accordance with EN 60669-1

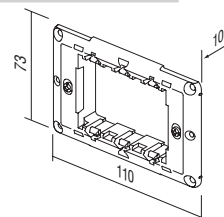

МОНТАЖНА РАМКА С ВИНТОВЕ 4М



NM40

- монтажна рамка 4М с винтове
- за монтаж в правоъгълни конзоли 4М
- подходяща за сглобяване с панели LINE, SOFT, PURE и EDGE
- в съответствие с EN 60669-1

MOUNTING FRAME WITH SCREWS 4M

- mounting frame 4M with screws
- for mounting on rectangular boxes 4M
- suitable for assembling with cover plates LINE, SOFT, PURE and EDGE
- in accordance with EN 60669-1

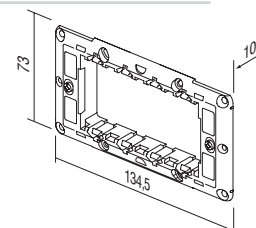

МОНТАЖНА РАМКА С ВИНТОВЕ 7М



NM70

- монтажна рамка 7М с винтове
- за монтаж в правоъгълни конзоли 7М
- подходяща за сглобяване с панели LINE, SOFT, PURE и EDGE
- в съответствие с EN 60669-1

MOUNTING FRAME WITH SCREWS 7M

- mounting frame 7M with screws
- for mounting on rectangular boxes 7M
- suitable for assembling with cover plates 7M
- in accordance with EN 60669-1

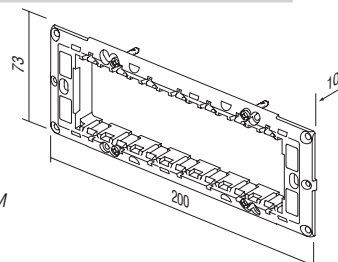

МОНТАЖНА РАМКА 7М, УКРЕПЕНА С ВИНТОВЕ

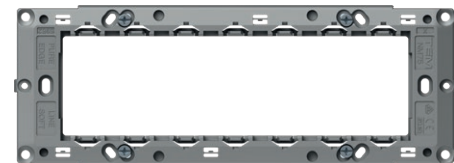

NM75

- укрепена монтажна рамка 7М с винтове – строга разновидност.
- монтаж в правоъгълна конзола с размер 7М – подходяща за съставяне с рамки 7М.
- Съответства на EN 60669-1.

REINFORCED MOUNTING FRAME WITH SCREWS 7M

- reinforced mounting frame 7M with screws – stiff version
- for mounting on rectangular boxes 7M
- suitable for assembling with cover plates 7M
- in accordance with EN 60669-1

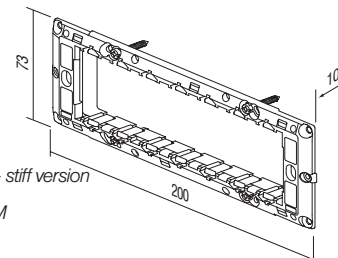

МОНТАЖНА РАМКА С ВИНТОВЕ 2x7М

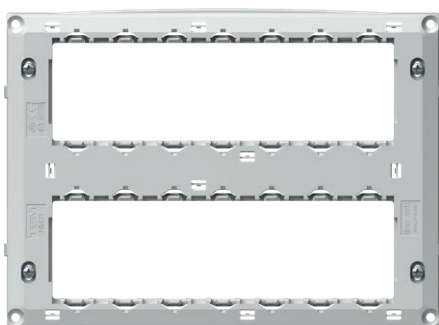

NM72

- монтажна рамка с винтове 2x7М
- за монтаж в правоъгълни конзоли 2x7М
- подходяща за сглобяване с панел 2x7М
- в съответствие с EN 60669-1

MOUNTING FRAME WITH SCREWS 2x7M

- mounting frame 2x7M with screws
- for mounting on rectangular boxes 2x7M
- suitable for assembling with cover plates 2x7M
- in accordance with EN 60669-1

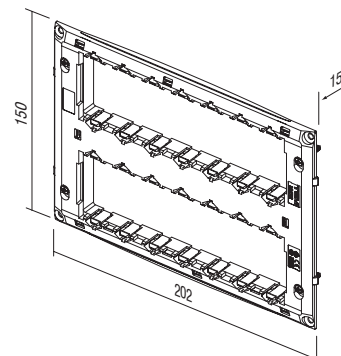

M O U N T I N G F R A M E S N M

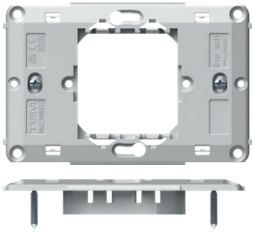

NM32

МОНТАЖНА РАМКА С ВИНТОВЕ 2/3М

- монтажна рамка 2/3М с винтове
- за монтаж в правоъгълни конзоли 3М
- подходяща за сглобяване с панели LINE, SOFT, PURE и EDGE
- в съответствие с EN 60669-1

MOUNTING FRAME WITH SCREWS 2/3M

- mounting frame 2/3M with screws
- for mounting on rectangular boxes 3M
- suitable for assembling with cover plates LINE, SOFT, PURE and EDGE
- in accordance with EN 60669-1

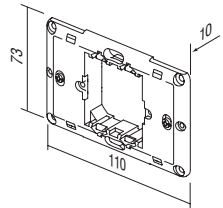



136



144



152



154

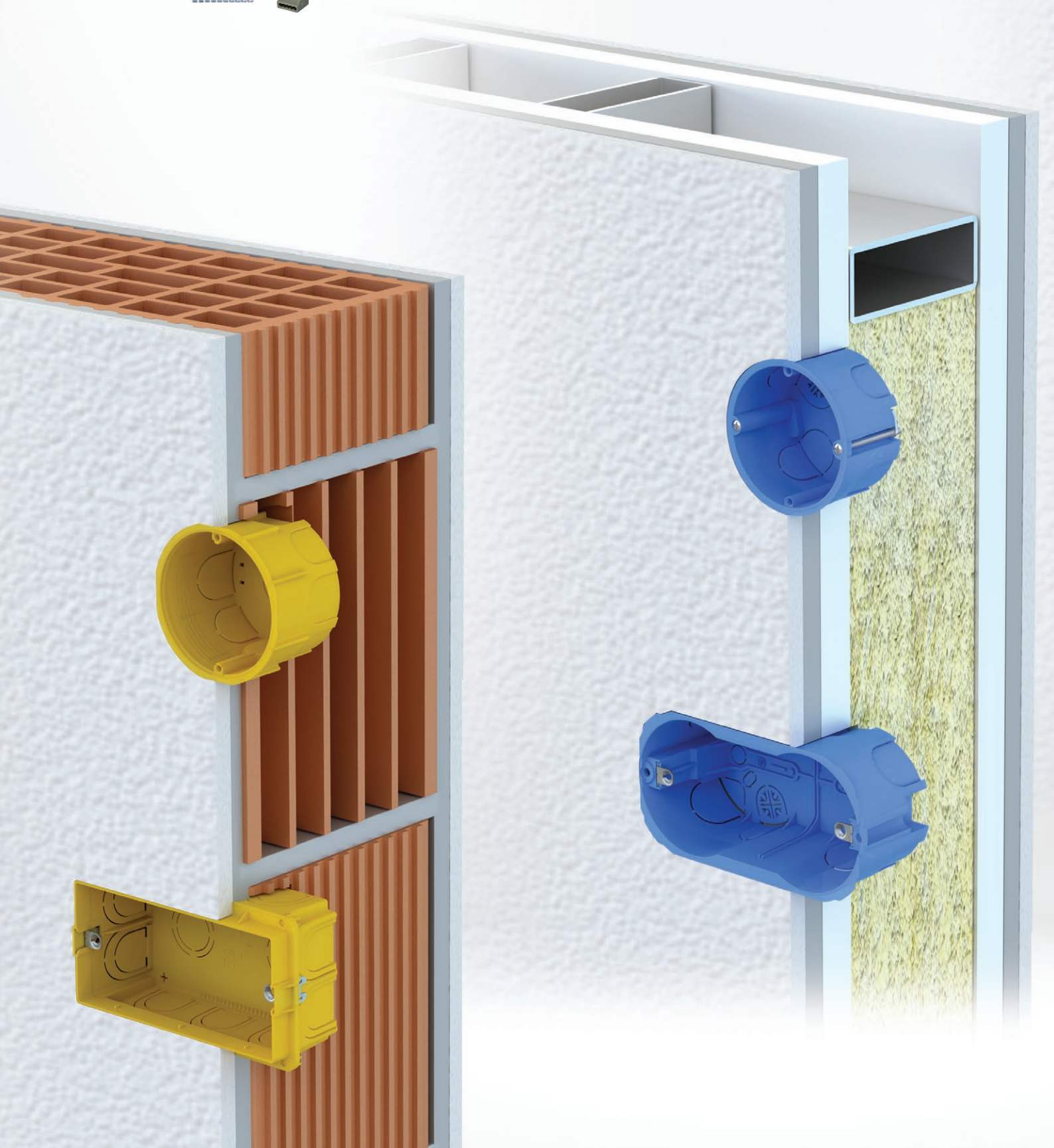



КУТТИ

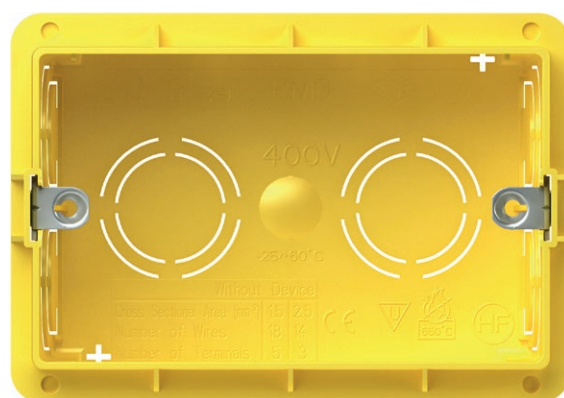

TEM



DE12



HE11



BE10

тип type	описание description	размер size
DE10	КРЪГЛИ КОНЗОЛИ ЗА ТУХЛЕНИ СТЕНИ ROUND BOX BRICK	SM60-01
HE10	КРЪГЛИ КОНЗОЛИ ЗА КУХИ СТЕНИ ROUND BOX HOLLOW WALL	SM68X40
BE10	КРЪГЛИ КОНЗОЛИ ЗА СТЕНИ ОТ БЕТОН ROUND BOX CONCRETE	
·	·	·
·	·	·

КРЪГЛИ КОНЗОЛИ ЗА ТУХЛЕНИ СТЕНИ SM60-01



DE10

- Ø60, дълбочина 40 mm
- 650° C, 500 V~
- в съответствие с IEC 60670-1
- без съдържание на халоген
- възможност за монтиране на монтажната рамка с винтове с Ø 3 mm

ROUND BOX BRICK SM60-01

- Ø60, depth 40mm
- 650°C, 500V~
- in accordance with IEC 60670-1
- halogen free
- option of mounting the mounting frame with Ø 3 mm screws

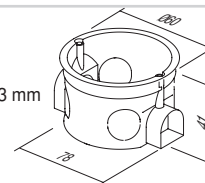

КРЪГЛИ ДЪЛБОКИ КОНЗОЛИ ЗА ТУХЛЕНИ СТЕНИ SM60-06



DE11

- Ø60, дълбочина 60 mm
- 650° C, 500 V~
- в съответствие с IEC 60670-1
- без съдържание на халоген
- възможност за монтиране на монтажната рамка с винтове с Ø 3 mm

ROUND BOX BRICK DEEP SM60-06

- Ø60, depth 60mm
- 650°C, 500V~
- in accordance with IEC 60670-1
- halogen free
- option of mounting the mounting frame with Ø 3 mm screws

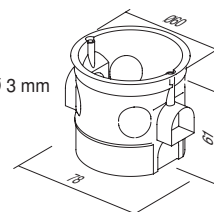

COMBI-CLIP SM60-03



DE30

- за вертикално закрепване на SM60-06 или SM60-01 на разстояние 91 mm
- в съответствие с IEC 60670-1
- без съдържание на халоген

COMBI-CLIP SM60-03

- for vertical fitting of boxes SM60-06 or SM60-01 on distance 91 mm
- in accordance with IEC 60670-1
- halogen free

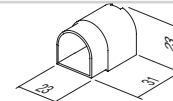

COMBI-CLIP SM60-04

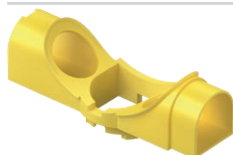

DE31







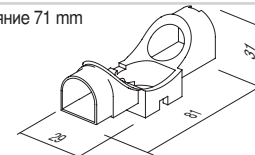



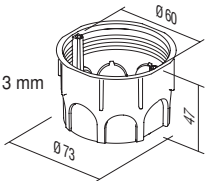

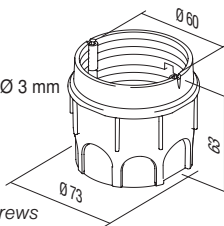
- за хоризонтално закрепване на SM60-06 или SM60-01 на разстояние 71 mm
- в съответствие с IEC 60670-1
- без съдържание на халоген

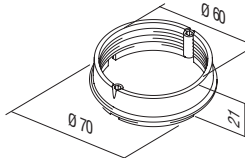
COMBI-CLIP SM60-04

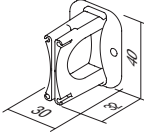
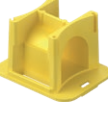
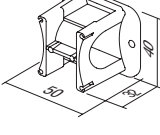
- for horizontal fitting of boxes SM60-06 or SM60-01 on distance 71mm
- in accordance with IEC 60670-1
- halogen free

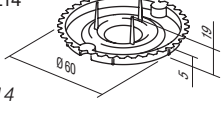

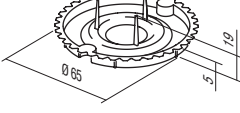
R O U N D B O X E S

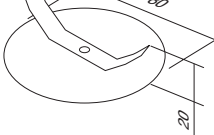
	DE12	КРЪГЛИ КОНЗОЛИ ЗА ТУХЛЕНИ СТЕНИ MD65-46	<ul style="list-style-type: none"> - Ø65, дълбочина 46 mm - 650° C, 500 V~ - в съответствие с IEC 60670-1 - без съдържание на халоген - възможност за монтиране на монтажната рамка с винтове с Ø 3 mm 	
		<i>ROUND BOX BRICK MD65-46</i>	<ul style="list-style-type: none"> - Ø65, depth 46mm - 650°C, 500V~ - in accordance with IEC 60670-1 - halogen free - option of mounting the mounting frame with Ø 3 mm screws 	
	DE13	КРЪГЛИ ДЪЛБОКИ КОНЗОЛИ ЗА ТУХЛЕНИ СТЕНИ MD65-60	<ul style="list-style-type: none"> - Ø65/60, дълбочина 62 mm - 650° C, 500 V~ - в съответствие с IEC 60670-1 - без съдържание на халоген - възможност за монтиране на монтажната рамка с винтове с Ø 3 mm 	
		<i>ROUND BOX BRICK DEEP MD65-60</i>	<ul style="list-style-type: none"> - Ø65/60, depth 62mm - 650°C, 500V~ - in accordance with IEC 60670-1 - halogen free - option of mounting the mounting frame with Ø 3 mm screws 	
	DE14	ДОПЪЛНИТЕЛЕН ДЕТАЙЛ ЗА MD65-46	<ul style="list-style-type: none"> - Ø65/60, дълбочина 17mm - 650° C, 500 V~ - в съответствие с IEC 60670-1 - без съдържание на халоген 	
		<i>ADDITIONAL PIECE FOR MD65-46</i>	<ul style="list-style-type: none"> - Ø65/60, depth 17mm - 650°C, 500V~ - in accordance with IEC 60670-1 - halogen free 	
	DE32	COMBI-CLIP MD65-71	<ul style="list-style-type: none"> - за закрепване на конзоли MD65 на разстояние 71 mm - в съответствие с IEC 60670-1 - без съдържание на халоген 	
		<i>COMBI-CLIP MD65-71</i>	<ul style="list-style-type: none"> - for fitting of boxes MD65 on distance 71mm - in accordance with IEC 60670-1 - halogen free 	
	DE33	COMBI-CLIP MD65-91	<ul style="list-style-type: none"> - за закрепване на конзоли MD65 на разстояние 91 mm - в съответствие с IEC 60670-1 - без съдържание на халоген 	
		<i>COMBI-CLIP MD65-91</i>	<ul style="list-style-type: none"> - for fitting of boxes MD65 on distance 91mm - in accordance with IEC 60670-1 - halogen free 	
	DE20	BOX COVER PROTECTIVE 60	<ul style="list-style-type: none"> - защитно капаче за конзола за конзола Ø60 DE10, DE11, DE13, DE14 - в съответствие с IEC 60670-1 - за защитаване на конзолата по време на измазване 	
		<i>BOX COVER PROTECTIVE 60</i>	<ul style="list-style-type: none"> - protective cover for box Ø60 for DE10, DE11, DE13, DE14 - in accordance with IEC 60670-1 - box protection during plastering 	
	DE21	BOX COVER PROTECTIVE 65	<ul style="list-style-type: none"> - защитно капаче за конзола за конзола Ø65 DE12 - в съответствие с IEC 60670-1 - за защитаване на конзолата по време на измазване 	
		<i>BOX COVER PROTECTIVE 65</i>	<ul style="list-style-type: none"> - protective cover for box Ø65 for DE12 - in accordance with IEC 60670-1 - box protection during plastering 	
	DE22	BOX COVER SM60	<ul style="list-style-type: none"> - декоративно капаче за конзоли Ø60 - в съответствие с IEC 60670-1 - без съдържание на халоген 	
		<i>BOX COVER DECORATIVE SM60</i>	<ul style="list-style-type: none"> - decorative cover for boxes Ø60 - in accordance with IEC 60670-1 - halogen free 	



указания за сглобяване /
assembly instructions

разстояние между конзолите /
distance between boxes: 71 mm

разстояние между конзолите /
distance between boxes: 91 mm

DE10,11

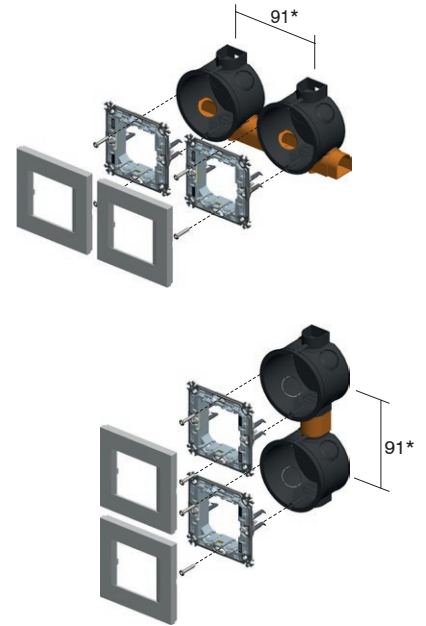
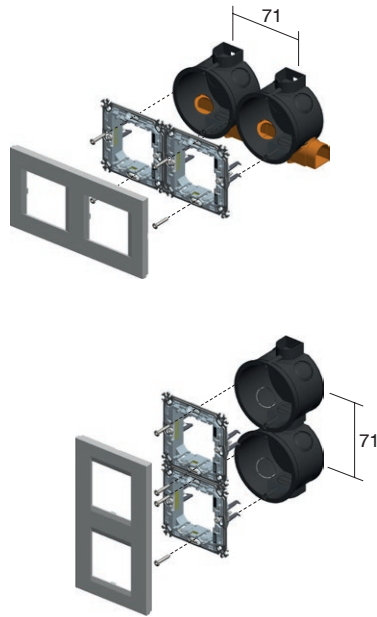
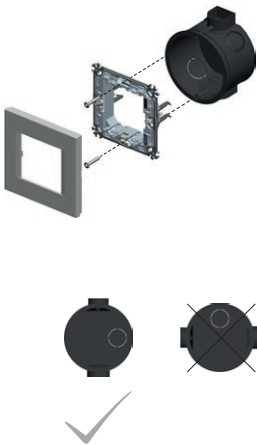

DE12,13

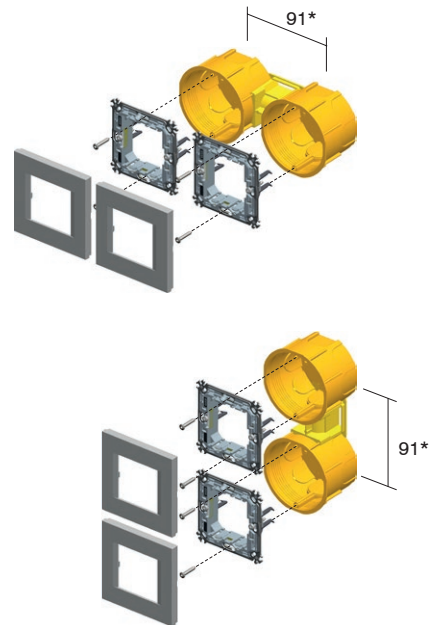
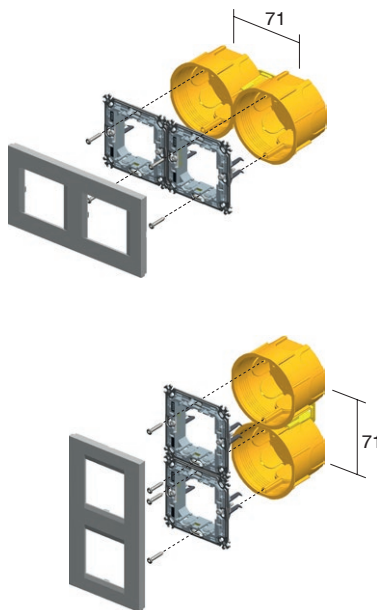
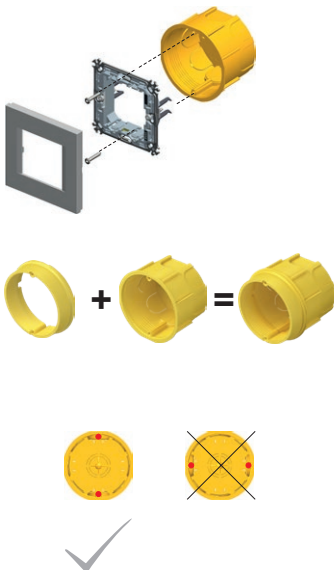

* за панелите PURE, EDGE минималното разстояние
между конзолите е 100 mm
* for PURE, EDGE cover plates the minimum distance
between boxes is 100mm

R O U N D B O X E S



DE10,11



DE12,13



NM20



NM24,26



DE10,11



DE12,13



NM10



DE10,11



DE12,13



NM23



71

2xDE10,11 + 2xDE31



2xDE12,13 + 1xDE32



2xNM20



2xNM24,26



2xDE10,11



2xDE12,13 + 1xDE32



2xNM20



2xNM24,26



3xDE10,11 + 3xDE31



3xDE12,13 + 2xDE32



3xNM20

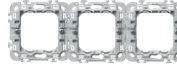

3xNM24,26

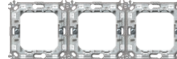

3xDE10,11



3xDE12,13 + 2xDE32



3xNM20



3xNM24,26

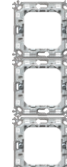

4xDE10,11 + 4xDE31



4xDE12,13 + 3xDE32



4xNM20



4xNM24,26



4xDE10,11



4xDE12,13 + 3xDE32



4xNM20



4xNM24,26



5xDE10,11



5xDE12,13 + 4xDE32



5xNM20



5xNM24,26



КРЪГЛА КОНЗОЛА ЗА КУХИ СТЕНИ SM68x40



HE10

- Ø60, дълбочина 40 mm
- прорязване на отвор Ø68
- 850° C, 400 V~
- в съответствие с IEC 60670-1
- монтаж с крачета
- без съдържание на халоген
- монтиране на монтажната рамка с винтове с Ø 3 mm

ROUND BOX HOLLOW WALL SM68x40

- Ø60, depth 40mm
- cutting hole Ø68
- 850°C, 400V~
- in accordance with IEC 60670-1
- mounting with claws
- halogen free
- mounting the mounting frame with Ø 3 mm screws

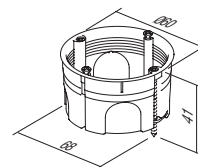

КРЪГЛА КОНЗОЛА ЗА КУХИ СТЕНИ SM68x55



HE11

- Ø60, дълбочина 55 mm
- прорязване на отвор Ø68
- 850° C, 400 V~
- в съответствие с IEC 60670-1
- монтаж с крачета
- без съдържание на халоген
- монтиране на монтажната рамка с винтове с Ø 3 mm

ROUND BOX HOLLOW WALL SM68x55

- Ø60, depth 55mm
- cutting hole Ø68
- 850°C, 400V~
- in accordance with IEC 60670-1
- mounting with claws
- halogen free
- mounting the mounting frame with Ø 3 mm screws

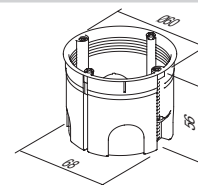

КРЪГЛИ КОНЗОЛИ ЗА СТЕНИ ОТ БЕТОН



BE10

- Ø60 mm, дълбочина 49 mm
- 650° C, 500 V~
- в съответствие с IEC 60670-1
- без съдържание на халоген
- монтиране на монтажната рамка с винтове с Ø 3 mm

ROUND BOX CONCRETE

- Ø60mm, depth 49mm
- 650°C, 500V~
- in accordance with IEC 60670-1
- halogen free
- mounting the mounting frame with Ø 3 mm screws

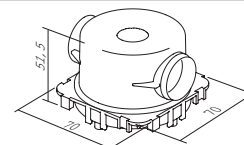

КРЪГЛИ ДЪЛБОКИ КОНЗОЛИ ЗА СТЕНИ ОТ БЕТОН



BE11

- Ø60 mm, дълбочина 58mm
- 650° C, 500 V~
- в съответствие с IEC 60670-1
- без съдържание на халоген
- монтиране на монтажната рамка с винтове с Ø 3 mm

ROUND BOX CONCRETE DEEP

- Ø60mm, depth 58mm
- 650°C, 500V~
- in accordance with IEC 60670-1
- halogen free
- mounting the mounting frame with Ø 3 mm screws

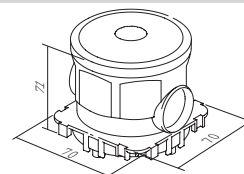

ЗАДНА ОПОРА ЗА КОНЗОЛА ЗА СТЕНИ ОТ БЕТОН



BE20

- за поддържане на конзоли за бетон с дистанционен профил BM82 срещу стената
- в съответствие с IEC 60670-1
- без съдържание на халоген

COUNTER BOX SUPPORT CONCRETE

- to support concrete boxes with discance profile BM82 for extreme loads
- in accordance with IEC 60670-1
- halogen free

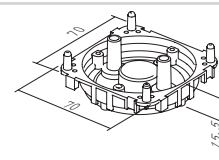

PIPE STOPPER CONCRETE BOX 16



BE21

- за закрепване на инсталационна тръба към конзола
- в съответствие с IEC 60670-1
- без съдържание на халоген

PIPE STOPPER CONCRETE BOX 16

- for firming installation pipe to box
- in accordance with IEC 60670-1
- halogen free

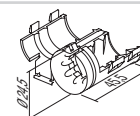

R O U N D B O X E S

кухи стени / hollow walls



бетон / concrete



указания за сглобяване /
assembly instructions

разстояние между конзолите /
distance between boxes: 71 mm

разстояние между конзолите /
distance between boxes: 91 mm

HE10,11

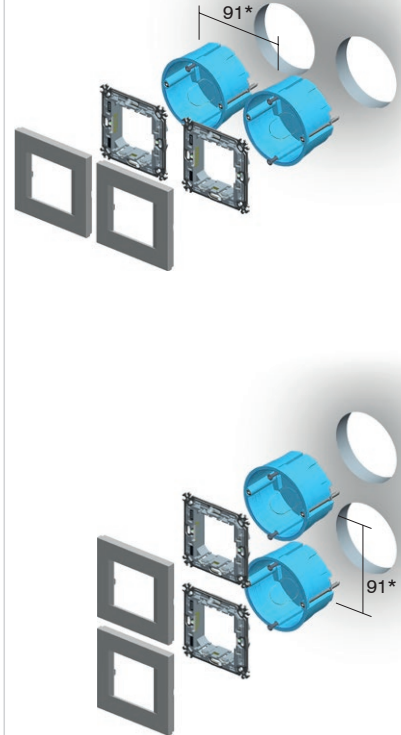
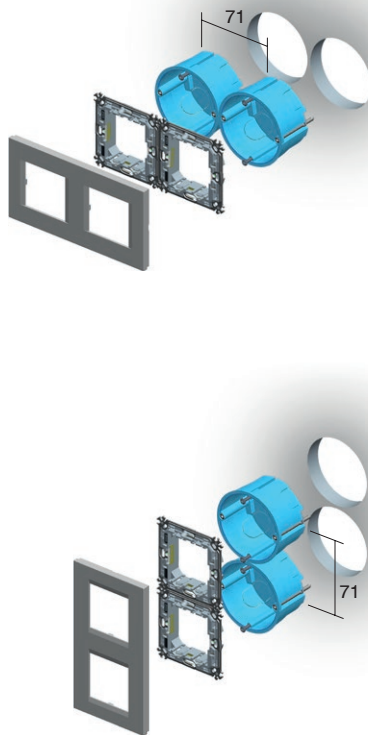
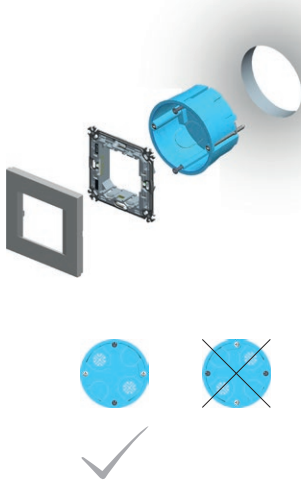

BE10

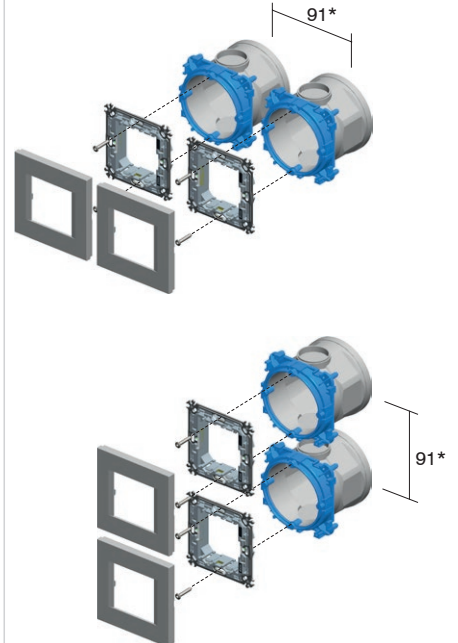
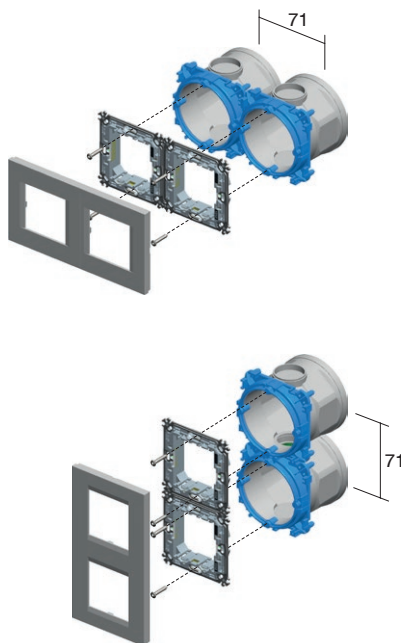
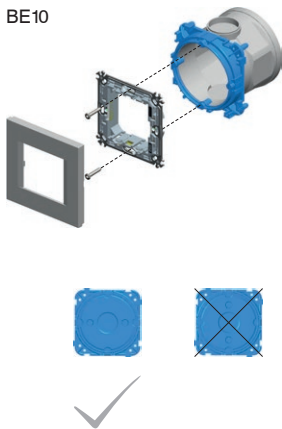

* за панелите PURE, EDGE минималното разстояние
между конзолите е 100 mm
* for PURE, EDGE cover plates the minimum distance
between boxes is 100mm

К Р Ъ Г Л И К О Н З О Л И

кухи стени/ hollow walls



бетон/ concrete



HE10,11



BE10,11



NM21



NM25,27



2M

HE10,11



BE10,11



NM11



1/2M

2xHE10,11



2xBE10,11



2xNM21



2xNM25,27



2x2M

HE10,11



BE10,11



NM32



2/3M

2xHE10,11



2xBE10,11



2xNM21



2xNM25,27



5xHE10,11



5xNM21



5xBE10,11



5xNM25,27



5x2M

3xHE10,11

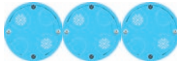

3xBE10,11



3xNM21



3xNM25,27

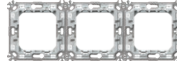

3x2M

3xHE10,11



3xBE10,11



3xNM21



3xNM25,27



4xHE10,11



4xBE10,11



4xNM21



4xNM25,27



4x2M

4xHE10,11



4xBE10,11



4xNM21



4xNM25,27



R O U N D B O X E S

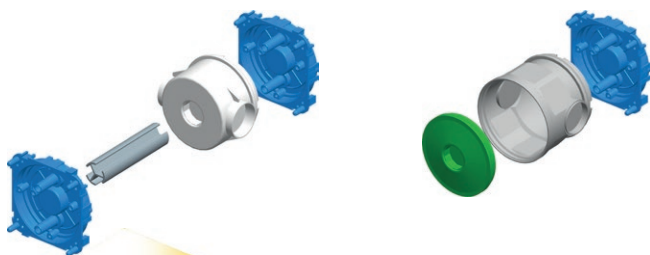

указания за сглобяване /
assembly instructions

1

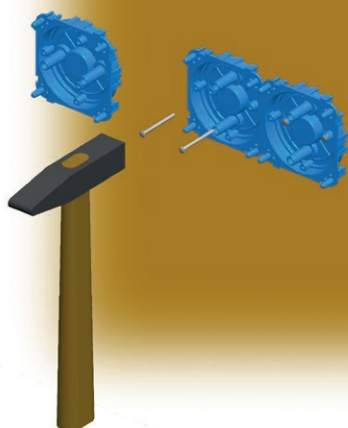

2

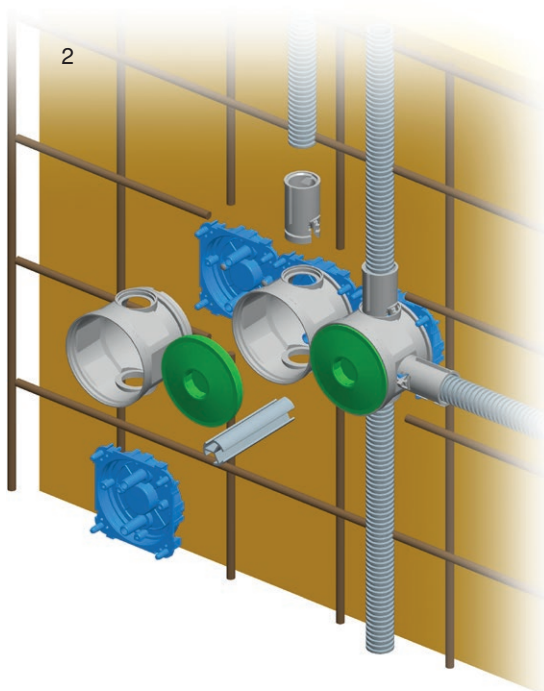

3

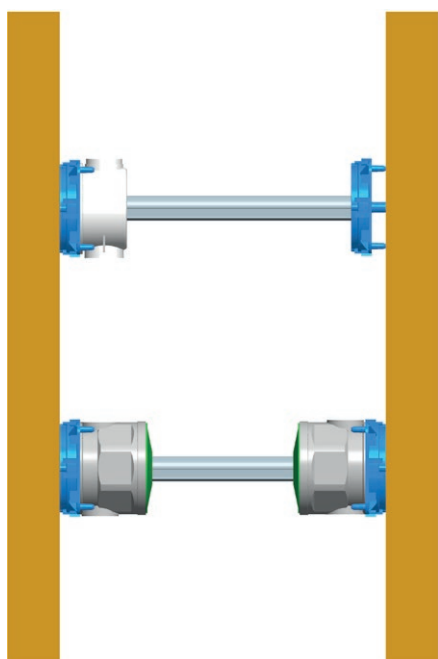

4

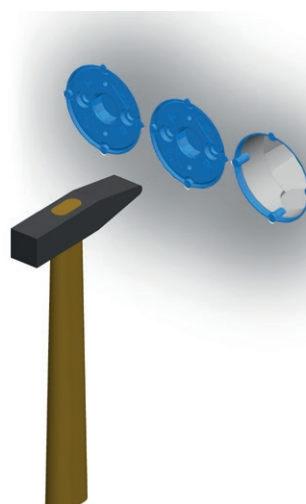

П Р А В О Ъ Г Ъ Л Н И К О Н З О Л И



DM30



HM30



BM30

тип type	описание description	размер size
DM30	ПРАВОЪГЪЛНА КОНЗОЛА ЗА ТУХЛЕНИ СТЕНИ <i>RECTANGULAR BOX BRICK</i>	PM3
HM30	ПРАВОЪГЪЛНА КОНЗОЛА ЗА КУХИ СТЕНИ <i>RECTANGULAR BOX HOLLOW WALL</i>	VM3
BM30	ПРАВОЪГЪЛНА КОНЗОЛА ЗА СТЕНИ ОТ БЕТОН <i>RECTANGULAR BOX CONCRETE</i>	BM3
·	·	·
·	·	·

ПРАВОЪГЪЛНА КОНЗОЛА ЗА ТУХЛЕНИ СТЕНИ PM3



DM30

- размер 3M, дълбочина 49 mm
- 650° C, 400V~
- в съответствие с IEC 60670-1
- без съдържание на халоген

RECTANGULAR BOX BRICK PM3

- size 3M, depth 49mm
- 650°C, 400V~
- in accordance with IEC 60670-1
- halogen free

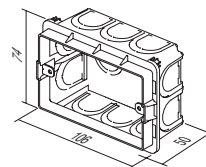

ПРАВОЪГЪЛНА КОНЗОЛА ЗА ТУХЛЕНИ СТЕНИ PM3-65



DM31

- размер 3M, дълбочина 65mm
- 650° C, 400V~
- в съответствие с IEC 60670-1
- без съдържание на халоген

RECTANGULAR BOX BRICK PM3-65

- size 3M, depth 65mm
- 650°C, 400V~
- in accordance with IEC 60670-1
- halogen free

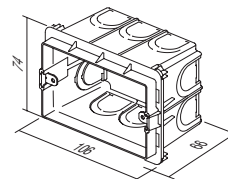

ПРАВОЪГЪЛНА КОНЗОЛА ЗА ТУХЛЕНИ СТЕНИ PM4



DM40

- размер 4M, дълбочина 49 mm
- 650° C, 400V~
- в съответствие с IEC 60670-1
- без съдържание на халоген

RECTANGULAR BOX BRICK PM4

- size 4M, depth 49mm
- 650°C, 400V~
- in accordance with IEC 60670-1
- halogen free

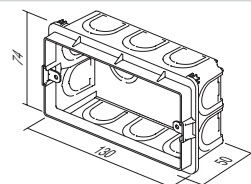

ПРАВОЪГЪЛНА КОНЗОЛА ЗА ТУХЛЕНИ СТЕНИ PM4-65



DM41

- размер 4M, дълбочина 65mm
- 650° C, 400V~
- в съответствие с IEC 60670-1
- без съдържание на халоген

RECTANGULAR BOX BRICK PM4-65

- size 4M, depth 65mm
- 650°C, 400V~
- in accordance with IEC 60670-1
- halogen free

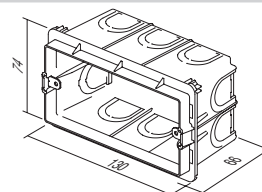

R E C T A N G U L A R B O X E S

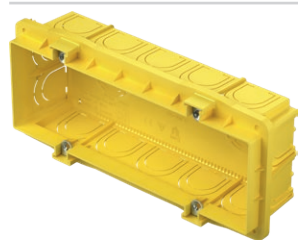

DM70

ПРАВОЪГЪЛНА КОНЗОЛА ЗА ТУХЛЕНИ СТЕНИ PM7

- размер 7М, дълбочина 49 mm
- 650° C, 400V~
- в съответствие с IEC 60670-1
- без съдържание на халоген

RECTANGULAR BOX BRICK PM7

- size 7M, depth 49mm
- 650°C, 400V~
- in accordance with IEC 60670-1
- halogen free

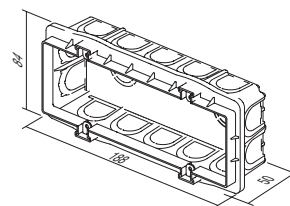

DM71

ПРАВОЪГЪЛНА КОНЗОЛА ЗА ТУХЛЕНИ СТЕНИ PM7-65

- размер 7М, дълбочина 65mm
- 650° C, 400V~
- в съответствие с IEC 60670-1
- без съдържание на халоген

RECTANGULAR BOX BRICK PM7-65

- size 7M, depth 65mm
- 650°C, 400V~
- in accordance with IEC 60670-1
- halogen free

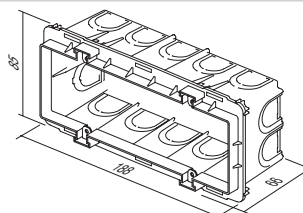

DM72

ПРАВОЪГЪЛНА КОНЗОЛА ЗА ТУХЛЕНИ СТЕНИ PM72-65

- размер 2x7М, дълбочина 64mm
- 650° C, 400V~
- в съответствие с IEC 60670-1
- без съдържание на халоген

RECTANGULAR BOX BRICK PM72-65

- size 2x7M, depth 64mm
- 650°C, 400V~
- in accordance with IEC 60670-1
- halogen free

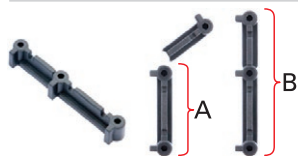
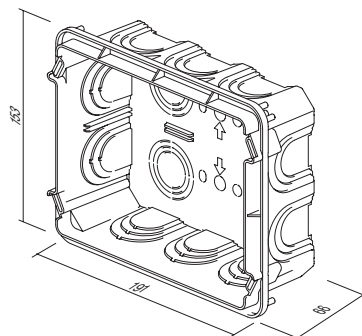

DM80

ДИСТАНЦИОНЕН ЕЛЕМЕНТ ЗА КОНЗОЛА PM

- за вертикален (A) и хоризонтален (B) монтаж на конзоли PM3, PM4 в PM7
- подходящ за декоративни панели LINE and SOFT (не за PURE, EDGE)

DISTANCE PIECE FOR BOX PM

- for vertical (A) and horizontal (B) fitting of boxes PM3, PM4 and PM7
- suitable for Line and Soft decorative cover plates (not for PURE and EDGE)

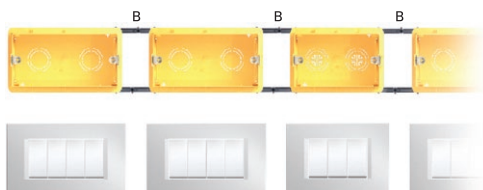
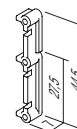

П Р А В О Ъ Г Ъ Л Н И К О Н З О Л И

BOX COVER PROTECTIVE PM3



DM33

- защитно капаче за конзола PM3
- в съответствие с IEC 60670-1
- без съдържание на халоген
- за защита на конзолата по време на измазване

BOX COVER PROTECTIVE PM3

- protective cover for box PM3
- in accordance with IEC 60670-1
- halogen free
- box protection during plastering

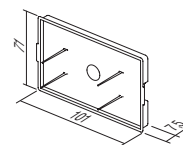

BOX COVER DECORATIVE PM3



DM34

- декоративно капаче за конзоли 3M
- винтовете са включени в доставката
- в съответствие с IEC 60670-1
- без съдържание на халоген

BOX COVER DECORATIVE PM3

- decorative cover for boxes 3M
- screws are included
- in accordance with IEC 60670-1
- halogen free

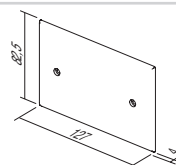

BOX COVER PROTECTIVE PM4



DM43

- защитно капаче за конзола PM4
- в съответствие с IEC 60670-1
- без съдържание на халоген
- за защита на конзолата по време на измазване

BOX COVER PROTECTIVE PM4

- protective cover for box PM4
- in accordance with IEC 60670-1
- halogen free
- box protection during plastering

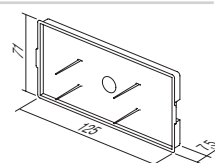

BOX COVER DECORATIVE PM4



DM44

- декоративно капаче за конзоли 4M
- винтовете са включени в доставката
- в съответствие с IEC 60670-1
- без съдържание на халоген

BOX COVER DECORATIVE PM4

- decorative cover for boxes 4M
- screws are included
- in accordance with IEC 60670-1
- halogen free

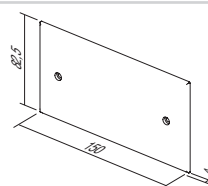

BOX COVER PROTECTIVE PM7

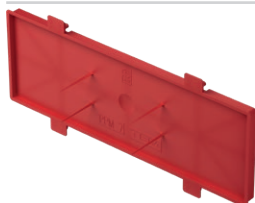

DM73

- защитно капаче за конзола PM7
- в съответствие с IEC 60670-1
- без съдържание на халоген
- за защита на конзолата по време на измазване

BOX COVER PROTECTIVE PM7

- protective cover for box PM7
- in accordance with IEC 60670-1
- halogen free
- box protection during plastering

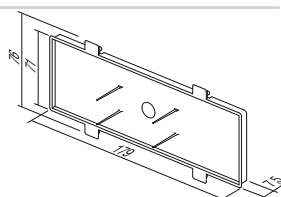

BOX COVER DECORATIVE PM7



DM74

- декоративно капаче за конзоли 7M
- винтовете са включени в доставката
- в съответствие с IEC 60670-1
- без съдържание на халоген

BOX COVER DECORATIVE PM7

- decorative cover for boxes 7M
- screws are included
- in accordance with IEC 60670-1
- halogen free

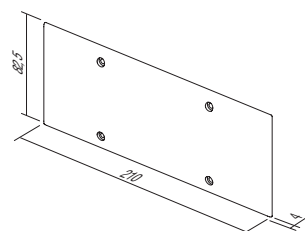

R E C T A N G U L A R B O X E S



DM75

BOX COVER DECORATIVE PM72

- декоративно капаче за конзоли 2x7M
- винтовете са включени в доставката
- в съответствие с IEC 60670-1

BOX COVER DECORATIVE PM72

- decorative cover for boxes 2x7M
- screws are included
- in accordance with IEC 60670-1

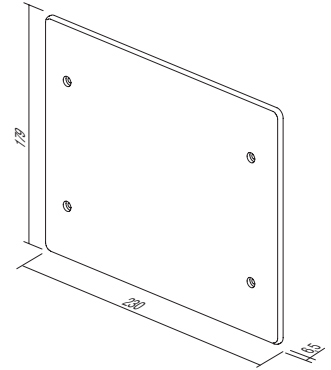

ПРАВОЪГЪЛНА КОНЗОЛА ЗА КУХИ СТЕНИ VM3



HM30

- размер 3M, дълбочина 49 mm
- прорязване на отвор 2xØ68/45 mm
- 850° C, 400 V~
- в съответствие с IEC 60670-1
- без съдържание на халоген

RECTANGULAR BOX HOLLOW WALL VM3

- size 3M, depth 49mm
- cutting hole 2xØ68/45mm
- 850°C, 400V~
- in accordance with IEC 60670-1
- halogen free

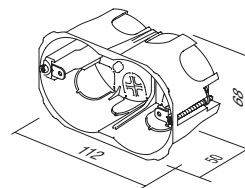

ПРАВОЪГЪЛНА КОНЗОЛА ЗА КУХИ СТЕНИ VM4



HM40

- размер 4M, дълбочина 49 mm
- прорязване на отвор 2xØ68/70 mm
- 850° C, 400 V~
- в съответствие с IEC 60670-1
- без съдържание на халоген

RECTANGULAR BOX HOLLOW WALL VM4

- size 4M, depth 49mm
- cutting hole 2xØ68/70mm
- 850°C, 400V~
- in accordance with IEC 60670-1
- halogen free

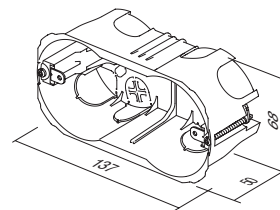

ПРАВОЪГЪЛНА КОНЗОЛА ЗА КУХИ СТЕНИ VM7



HM70

- размер 7M, дълбочина 49 mm
- прорязване на отвор 2xØ68/120 mm
- 850° C, 400 V~
- в съответствие с IEC 60670-1
- без съдържание на халоген

RECTANGULAR BOX HOLLOW WALL VM7

- size 7M, depth 49mm
- cutting hole 2xØ68/120mm
- 850°C, 400V~
- in accordance with IEC 60670-1
- halogen free

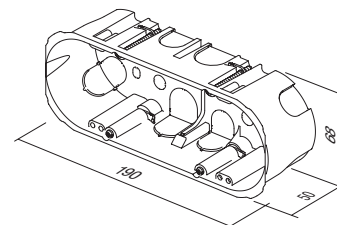

ПРАВОЪГЪЛНА КОНЗОЛА ЗА КУХИ СТЕНИ VM72



HM72

- размер 2x7M, дълбочина 63mm
- 850° C, 400 V~
- в съответствие с IEC 60670-1
- без съдържание на халоген

RECTANGULAR BOX HOLLOW WALL VM72

- size 2x7M, depth 63mm
- 850°C, 400V~
- in accordance with IEC 60670-1
- halogen free

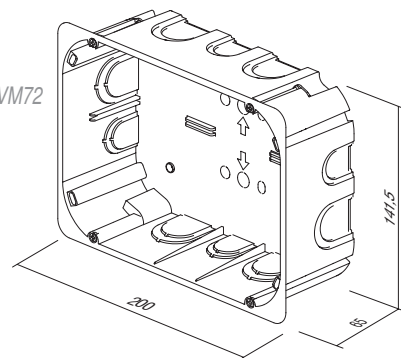

R E C T A N G U L A R B O X E S

ПРАВОЪГЪЛНА КОНЗОЛА ЗА СТЕНИ ОТ БЕТОН ВМ3



ВМ30

- размер 3М, дълбочина 60 mm
- 650° C, 400V~
- в съответствие с IEC 60670-1
- без съдържание на халоген

RECTANGULAR BOX CONCRETE BM3

- size 3M, depth 60mm
- 650°C, 400V~
- in accordance with IEC 60670-1
- halogen free

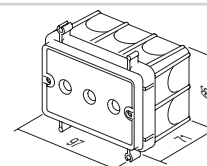

ПРАВОЪГЪЛНА КОНЗОЛА ЗА СТЕНИ ОТ БЕТОН ВМ4



ВМ40

- размер 4М, дълбочина 60 mm
- 650° C, 400V~
- в съответствие с IEC 60670-1
- без съдържание на халоген

RECTANGULAR BOX CONCRETE BM4

- size 4M, depth 60mm
- 650°C, 400V~
- in accordance with IEC 60670-1
- halogen free

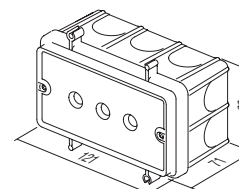

ПРАВОЪГЪЛНА КОНЗОЛА ЗА СТЕНИ ОТ БЕТОН ВМ7



ВМ70

- размер 7М, дълбочина 60 mm
- 650° C, 400V~
- в съответствие с IEC 60670-1
- без съдържание на халоген

RECTANGULAR BOX CONCRETE BM7

- size 7M, depth 60mm
- 650°C, 400V~
- in accordance with IEC 60670-1
- halogen free

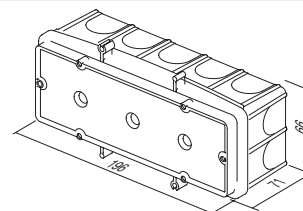

FIXING COMBI-CLIP ВМ



ВМ80

- за бързо закрепване правоъгълни конзоли ВМ върху подсилваща шина
- подходящо за пръти с диаметър до Ø8 mm

FIXING COMBI-CLIP ВМ

- for fast fixation of ВМ rectangular boxes on reinforcing bar
- suitable for bar diameter up to Ø8mm

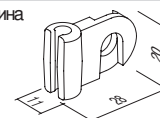

ДИСТАНЦИОНЕН ПРОФИЛ ЗА КОНЗОЛИ ВМ



ВМ82

- за поддържане на конзоли ВМ с опора върху стената
- дължина l=1 m, диаметър Ø20 mm

DISTANCE PROFIL FOR BOXES ВМ

- to support boxes ВМ with counter box support on opposite wall
- length l=1m, diameter Ø20mm

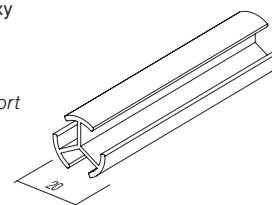

П Р А В О Ъ Г Ъ Л Н И К О Н З О Л И



тухла/ brick



кухи стени/ hollow walls



бетон/ concrete



DM30



NM30



HM30



BM30



3M

DM40



NM40



HM40



BM40



4M

DM70



NM70,75



HM70



BM70



7M

DM72



NM72

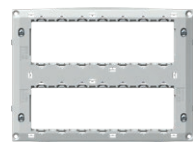

HM72

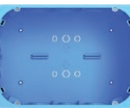

2x7M

DM30



NM32



HM30



BM30



2/3M

R E C T A N G U L A R B O X E S

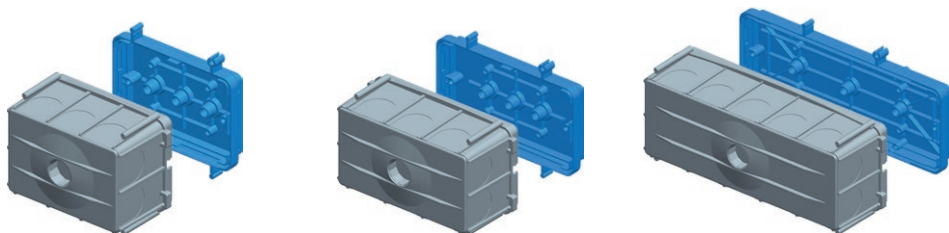

указания за сглобяване /
assembly instructions

1

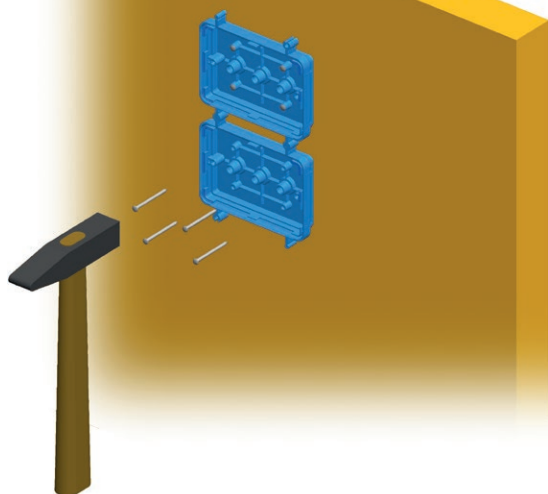

2

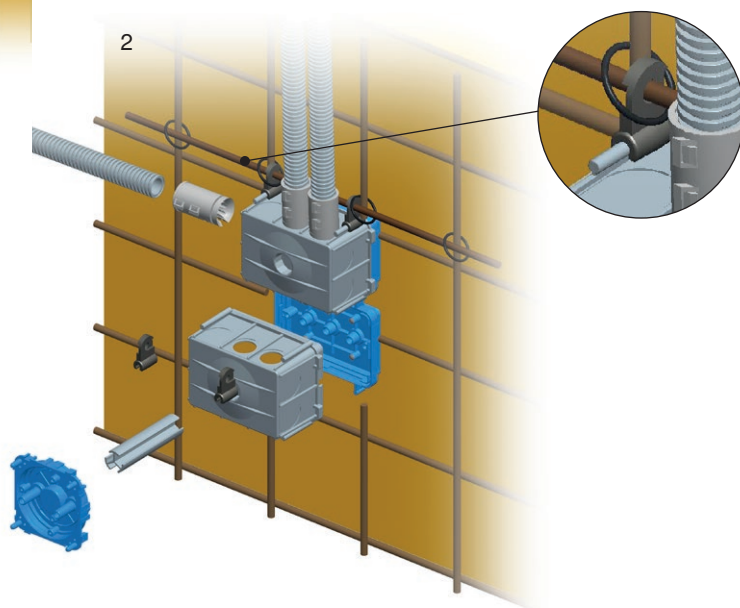

3

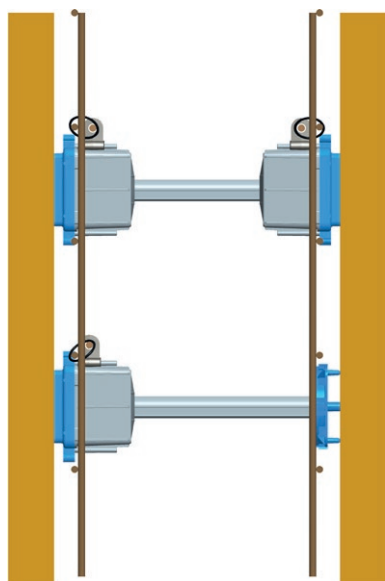

4

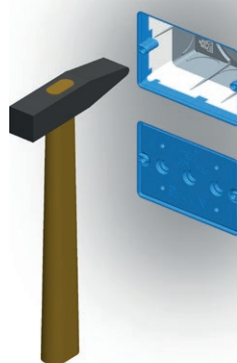

С Ъ Е Д И Н И Т Е Л Н И К У Т И И

КРЪГЛА СЪЕДИНИТЕЛНА КОНЗОЛА ЗА ТУХЛЕНИ СТЕНИ DSM78



DW10

- Ø78, дълбочина 40 mm
- 650° C, 500 V~
- в съответствие с IEC 60670-1 и IEC 60670-22
- без съдържание на халоген

CONNECTION ROUND BOX BRICK DSM78

- Ø78, depth 40mm
- 650°C, 500V~
- in accordance with IEC 60670-1 and IEC 60670-22
- halogen free

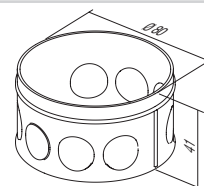

КРЪГЛА СЪЕДИНИТЕЛНА КОНЗОЛА ЗА КУХИ СТЕНИ SM78x45



HW10

- Ø78, дълбочина 45 mm
- прорязване на отвор Ø80
- 850° C, 400 V~
- в съответствие с IEC 60670-1 и IEC 60670-22
- монтаж с крачета
- без съдържание на халоген

CONNECTION ROUND BOX HOLLOW WALL SM78x45

- Ø78, depth 45mm
- cutting hole Ø80
- 850°C, 400V~
- in accordance with IEC 60670-1 and IEC 60670-22
- mounting with claws
- halogen free

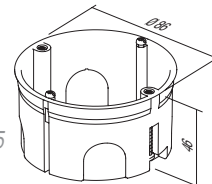

BOX COVER SM78



DE23

- декоративно капаче за конзоли Ø78
- в съответствие с IEC 60670-1 и IEC 60670-22
- без съдържание на халоген

BOX COVER DECORATIVE SM78

- decorative cover for boxes Ø78
- in accordance with IEC 60670-1 and IEC 60670-22
- halogen free

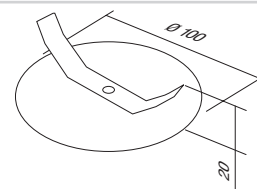

BOX COVER PROTECTIVE 78



DE24

- защитно капаче за конзола Ø78
- в съответствие с IEC 60670-1 и IEC 60670-22
- без съдържание на халоген

BOX COVER PROTECTIVE 78

- protective cover for box Ø78
- in accordance with IEC 60670-1 and IEC 60670-22
- halogen free

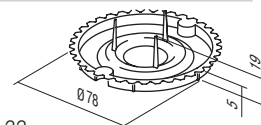

КВАДРАТНА СЪЕДИНИТЕЛНА КОНЗОЛА ЗА КУХИ СТЕНИ SM105x105



HW20

- размер 105x105mm, дълбочина 50 mm
- прорязване на отвор с приложения шаблон
- 850° C, 400 V~
- в съответствие с IEC 60670-1 и IEC 60670-22
- монтаж с крачета
- без съдържание на халоген

CONNECTION SQUARE BOX HOLLOW WALL SM105x105

- size 105x105mm, depth 50mm
- cutting hole according to attached template
- 850°C, 400V~
- in accordance with IEC 60670-1 and IEC 60670-22
- mounting with claws
- halogen free

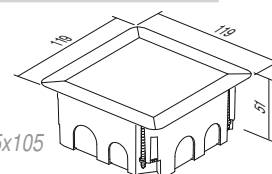

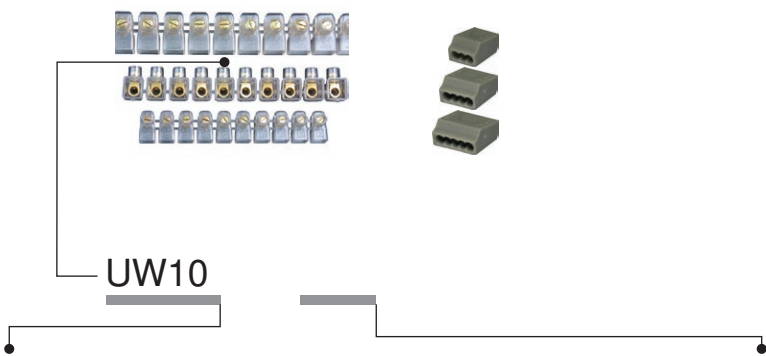

тип type	описание description	технически данни technical data	размер size	цвет colour
UW10	1 РЕД КЛЕМОРЕДИ ЗАТВОРЕНИ 1 ROW TERMINAL BLOCKS	2x2.5mm ²	10P	<input checked="" type="checkbox"/> TS прозрачен transparent
UW11	1 РЕД КЛЕМОРЕДИ ЗАТВОРЕНИ 1 ROW TERMINAL BLOCKS	2x4mm ²	10P	<input checked="" type="checkbox"/> CO цвет colour
UW12	1 РЕД КЛЕМОРЕДИ ЗАТВОРЕНИ 1 ROW TERMINAL BLOCKS	2x6mm ²	10P	<input type="checkbox"/> WH бял цвет white
...	<input type="checkbox"/> GY сив grey

1 РЕД КЛЕМОРЕДИ ЗАТВОРЕНИ



- 450 V~; 2x2,5 mm² ÷ 2x6 mm²
- термопласт PC, прозрачен
- брой полюси: 10

1 ROW TERMINAL BLOCKS CLOSED

- 450V~; 2x2.5mm² ÷ 2x6mm²
- thermoplast PC, transparent
- number of poles: 10

UW10TS	(NS12)	2x2.5mm ²	10P
UW11TS	(NS12)	2x4mm ²	10P
UW12TS	(NS12)	2x6mm ²	10P

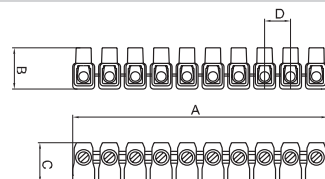

	A	B	C	D
2x2.5 □	110	17.5	17.5	11
2x4 □	128	21	19	12.5
2x6 □	146	21.5	22	15

1 РЕД КЛЕМОРЕДИ

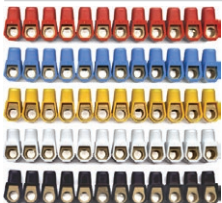

- 450 V~; 2x2,5 mm² ÷ 2x6 mm²
- термопласт PA
- предлага се в различни цветове
- брой полюси: 12

1 ROW TERMINAL BLOCKS

- 450V~; 2x2.5mm² ÷ 2x6mm²
- thermoplast PA
- available in different colours
- number of poles: 12

UW15CO	(NS12)	2x2.5mm ²	12P
UW16CO	(NS12)	2x4mm ²	12P
UW17CO	(NS12)	2x6mm ²	12P

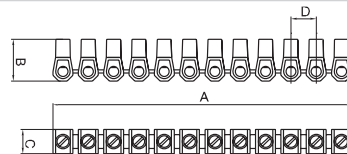

	A	B	C	D
2x2.5 □	110	16.4	9	10
2x4 □	118.8	19	10	10
2x6 □	129.8	21.3	11	11.8

2 РЕДА КЛЕМОРЕДИ PP

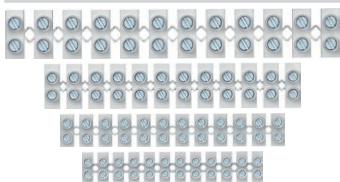

- 450 V~; 1 mm² ÷ 16 mm²
- термопласт полипропилен PP, бял
- за температури до 80°С
- брой полюси: 12

2 ROW TERMINAL BLOCKS PP

- 450V~; 1mm² ÷ 16mm²
- thermoplast polypropylene PP, white
- for temperatures up to 80°C
- number of poles: 12



					A	B	C	D	E
UW29WHPP	1.0-4.0mm ²	24 A	450 V		94,9	13	16,6	8,1	6,4
UW30WHPP	1.5-6.0mm ²	32 A	450 V		116,5	14,9	18,9	10	7,3
UW31WHPP	2.5-10mm ²	41 A	450 V		133,8	17,3	23,4	11,5	10
UW32WHPP	4-16mm ²	76 A	450 V		174,5	20,7	25	15	11

2 РЕДА КЛЕМОРЕДИ РА

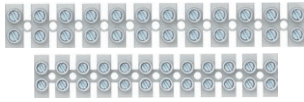

- 450 V~; 1 mm² ÷ 16 mm²
- термопласт полиамид РА, бял
- за температури до 110° C
- брой полюси: 12

2 ROW TERMINAL BLOCKS PA

- 450V~; 1mm² ÷ 16mm²
- thermoplast polyamide PA, white
- for temperatures up to 110°C
- number of poles: 12

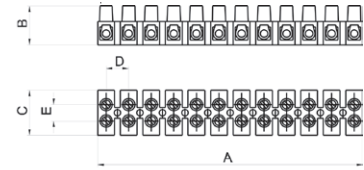

					A	B	C	D	E
UW27WHPA	2.5-10mm ²	41 A	450 V		132,8	17,3	22,2	11,5	10
UW28WHPA	4-16mm ²	76 A	450 V		173,9	20,8	25,2	15	11

СЪЕДИНИТЕЛИ С ВКАРВАНЕ НА ПРОВОДНИЦИТЕ



- 24 A 450 V~, термопласт РА, сив
- брой полюси: 3÷8
- контакти чрез вкарване 0,5÷1,5 mm², за твърди проводници
- в съответствие с EN 60998-1

PLUG-IN WIRE CONNECTORS

- 24A 450V~, thermoplast PA, grey
- number of poles: 3÷8
- plug-in contacts 0.5÷1.5mm², for rigide wires
- in accordance with EN 60998-1

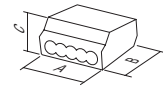

UW40GY	PC153	1.5mm ²	3P	3P	A	B	C
UW41GY	PC155	1.5mm ²	5P	5P	12	18	9
UW42GY	PC158	1.5mm ²	8P	8P	17	18	9
					26	18	9

СЪЕДИНИТЕЛИ С ВКАРВАНЕ НА ПРОВОДНИЦИТЕ



- 24 A 450 V~, термопласт РА, сив
- брой полюси: 3÷5
- контакти чрез вкарване 1,5÷2,5 mm², за твърди проводници
- в съответствие с EN 60998-1

PLUG-IN WIRE CONNECTORS

- 24A 450V~, thermoplast PA, grey
- number of poles: 3÷5
- plug-in contacts 1.5÷2.5mm², for rigide wires
- in accordance with EN 60998-1

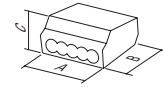

UW45GY	PC253	2.5mm ²	3P	3P	A	B	C
UW46GY	PC254	2.5mm ²	4P	4P	14	19	9
UW47GY	PC255	2.5mm ²	5P	5P	17	19	9
					21	19	9

СЪЕДИНИТЕЛ С ВКАРВАНЕ НА ПРОВОДНИЦИТЕ



- 24 A 450 V~, термопласт РА, сив
- брой полюси: 2 (твърд проводник)+1 (мек проводник)
- контакти чрез вкарване 1,5÷2,5 mm²
- в съответствие с EN 60998-1

PLUG-IN WIRE CONNECTOR

- 24A 450V~, thermoplast PA, grey
- number of poles: 2 (rigide wire)+1 (soft wire)
- plug-in contacts 1.5÷2.5mm²
- in accordance with EN 60998-1

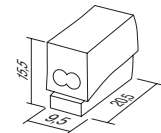

UW50WH	PC302	2.5mm ²	2/1P
--------	-------	--------------------	------



158



159



161

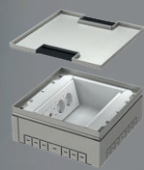

166



ДИСТРИБУЦИЯ



TEM

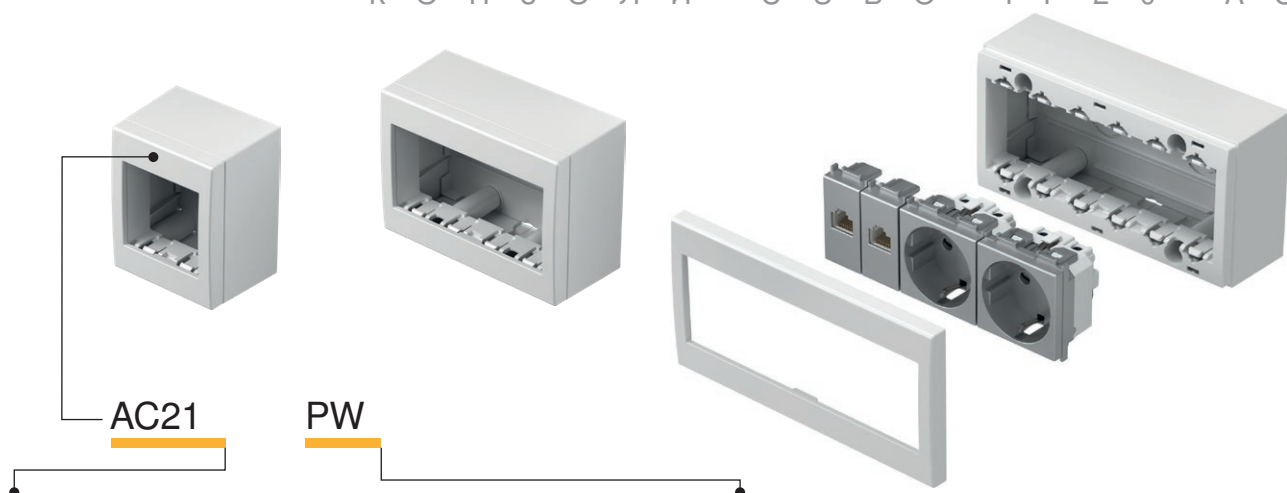

тип type	описание description	технически данни technical data	размер size	цвет colour
AC11	КОНЗОЛА NO CUBO СЪС ЗАДЕН КАПАК SURFACE MOUNT BOX WITH BACK SIDE COVER	IP20	1M	<input type="checkbox"/> PW снежнобял цвят polar white <input type="checkbox"/> ES сребрист цвят с анодизирано покритие elox silver
AC21	КОНЗОЛА NO CUBO СЪС ЗАДЕН КАПАК SURFACE MOUNT BOX WITH BACK SIDE COVER	IP20	2M	<input type="checkbox"/> IW слонова кост ivory white <input type="checkbox"/> AT антрацит anthracite
AC41	КОНЗОЛА NO CUBO СЪС ЗАДЕН КАПАК SURFACE MOUNT BOX WITH BACK SIDE COVER	IP20	4M	<input type="checkbox"/> AT антрацит anthracite

КОНЗОЛА NO CUBO СЪС ЗАДЕН КАПАК IP20 1M

AC11PW
 AC11ES
 AC11IW
 AC11AT

- конзола IP20 1M
- за външен монтаж на елементи
- подходяща за ключове SM
- в съответствие с EN 60669-1

BOX NO CUBO WITH BACK SIDE COVER IP20 1M
 - box IP20 1M
 - for surface mounting of elements
 - suitable to SM switches
 - in accordance with EN 60669-1

КОНЗОЛА NO CUBO СЪС ЗАДЕН КАПАК IP20 2M

AC21PW
 AC21ES
 AC21IW
 AC21AT

- конзола IP20 2M
- за външен монтаж на елементи
- в съответствие с EN 60669-1, EN60884-1

BOX NO CUBO WITH BACK SIDE COVER IP20 2M
 - box IP20 2M
 - for surface mounting of elements
 - in accordance with EN 60669-1, EN60884-1

КОНЗОЛА NO CUBO СЪС ЗАДЕН КАПАК IP20 4M

AC41PW
 AC41ES
 AC41IW
 AC41AT

- конзола IP20 4M
- за външен монтаж на елементи
- в съответствие с EN 60669-1, EN60884-1

BOX NO CUBO WITH BACK SIDE COVER IP20 4M
 - box IP20 4M
 - for surface mounting of elements
 - in accordance with EN 60669-1, EN60884-1

КОНЗОЛА NO CUBO СЪС ЗАДЕН КАПАК IP20 6M

AC61PW
 AC61ES
 AC61IW
 AC61AT

- конзола IP20 6M
- за външен монтаж на елементи
- в съответствие с EN 60669-1, EN60884-1

BOX NO CUBO WITH BACK SIDE COVER IP20 6M
 - box IP20 6M
 - for surface mounting of elements
 - in accordance with EN 60669-1, EN60884-1

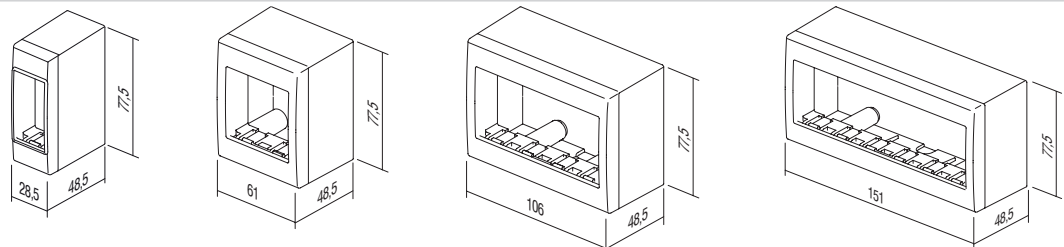

B O X E S C U B O I P 5 5 A Q



тип type	описание description	технически данни technical data	размер size	ЦВЯТ colour
AQ20	КОНЗОЛА NO CUBO OUTDOOR SURFACE MOUNT BOX	IP55	2M	<input type="checkbox"/> PW снежнобял цвят polar white
AQ22	КОНЗОЛА NO CUBO OUTDOOR SURFACE MOUNT BOX	IP55	2x2M	<input checked="" type="checkbox"/> GY сив grey
AQ30	КОНЗОЛА NO CUBO OUTDOOR SURFACE MOUNT BOX	IP55	3M	
AQ31	КОНЗОЛА PO CUBO OUTDOOR SURFACE MOUNT BOX	IP55	3M	

КОНЗОЛА NO CUBO IP55 2M



- AQ20PW
 AQ20GY

- конзола IP55 2M
- за външен монтаж
- IP55 за използване във влажни зони
- в съответствие с IEC 23-48, CEI 60670

BOX NO CUBO IP55 2M

- box IP55 2M
- for surface mounting
- IP55 for usage in humid areas
- in accordance with CEI 23-48, EN 60670



КОНЗОЛА NO CUBO IP55 2x2M



- AQ22PW
 AQ22GY

- конзола IP55 2x2M
- за външен монтаж
- IP55 за използване във влажни зони
- в съответствие с IEC 23-48, CEI 60670

BOX NO CUBO IP55 2x2M

- box IP55 2x2M
- for surface mounting
- IP55 for usage in humid areas
- in accordance with CEI 23-48, EN 60670



КОНЗОЛА NO CUBO IP55 3M



- AQ30PW
 AQ30GY

- конзола IP55 3M
- за външен монтаж
- IP55 за използване във влажни зони
- в съответствие с IEC 23-48, CEI 60670

BOX NO CUBO IP55 3M

- box IP55 3M
- for surface mounting
- IP55 for usage in humid areas
- in accordance with CEI 23-48, EN 60670



КУТИЯ ПО CUBO IP55 2M



- AQ21PW
- AQ21AT

- кутия IP55 2M
- може да се съчетава с функционални елементи на Modul
- за вграден монтаж
- IP55 за употреба в помещения с наличие на влага
- в съответствие със CEI 23-48, EN 60670

BOX PO CUBO IP55 2M

- box IP55 2M
- can be combined with all Modul functional elements
- for flush mounting
- IP55 for usage in humid areas
- in accordance with CEI 23-48, EN 60670



КОНЗОЛА ПО CUBO IP55 3M



- AQ31PW
- AQ31GY

- конзола IP55 3M
- за скрит монтаж
- IP55 за използване във влажни зони
- в съответствие с IEC 23-48, CEI 60670

BOX PO CUBO IP55 3M

- box IP55 3M
- for flush mounting
- IP55 for usage in humid areas
- in accordance with CEI 23-48, EN 60670

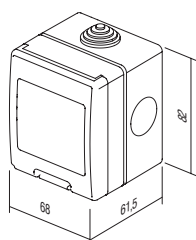

AQ20

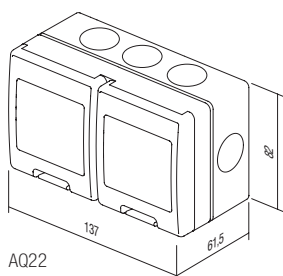

AQ22

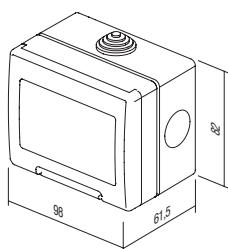

AQ30

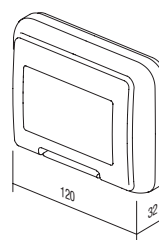

AQ31

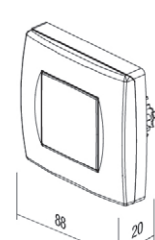

AQ21

TRUNKING SYSTEM ALUMINIUM

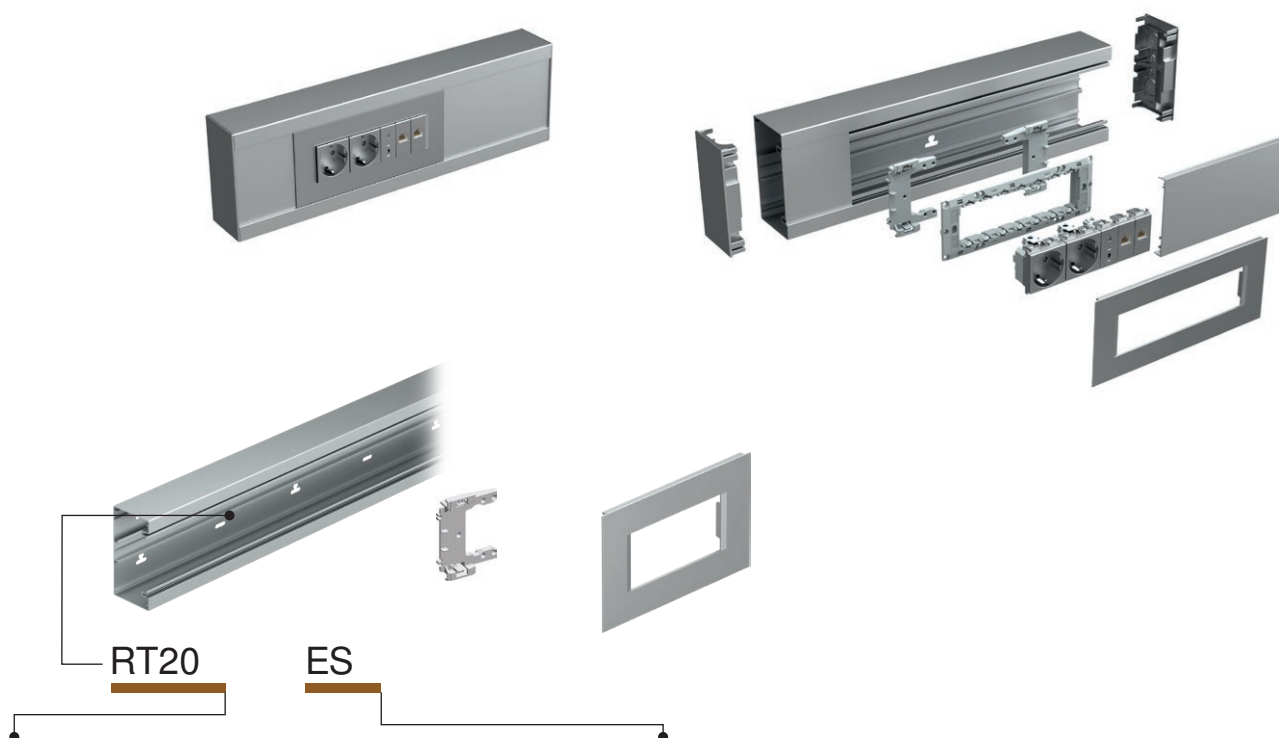

тип type	описание description	размер size	цвет colour
RT10	АДАПТЕР MA 92 ADAPTER MA 92	/	■ ES сребрист цвят с анодизирано покритие elox silver-mat
RT12	ПАНЕЛ MA 92 COVER PLATE MA 92	2/3M	□ PW бял матов (RAL 9016) white-mat
RT14	ПАНЕЛ MA 92 COVER PLATE MA 92	4M	
⋮	⋮	⋮	

АДАПТЕР MA 92



RT10

- адаптер за закрепване за монтажни рамки 2/3M, 4M или 7M върху канал MA без конзола
- за всяка монтажна рамка са нужни два адаптера
- в съответствие с EN 50085-1

ADAPTER MA 92

- adapter for fixing mounting frames 2/3M, 4M or 7M on MA trunking without box
- each mounting frame needs two adapters
- in accordance with EN 50085-1

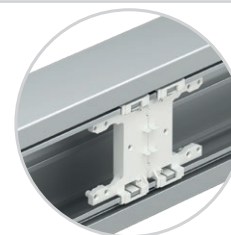

ПАНЕЛ MA 92 2/3M



■ RT12ES
□ RT12PW

- декоративен панел MA 2/3M
- в съответствие с EN 50085-1

COVER PLATE MA 92 2/3M

- decorative cover plate MA 2/3M
- in accordance with EN 50085-1

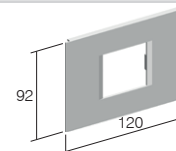

ПАНЕЛ MA 92 4M



■ RT14ES
□ RT14PW

- декоративен панел MA 4M
- в съответствие с EN 50085-1

COVER PLATE MA 92 4M

- decorative cover plate MA 4M
- in accordance with EN 50085-1

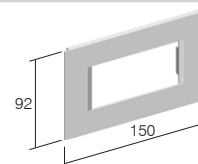

ПАНЕЛ MA 92 7M



■ RT17ES
□ RT17PW

- декоративен панел MA 7M
- в съответствие с EN 50085-1

COVER PLATE MA 92 7M

- decorative cover plate MA 7M
- in accordance with EN 50085-1

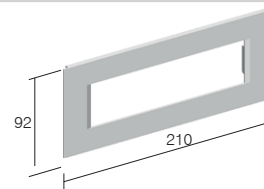

ОСНОВА ЗА КАНАЛ МА 130x65



- RT20ES
- RT20PW

- основа за канал от екструдирани алуминий
- височина 130 mm, дължина 2 m
- DIN – релса 35 mm долен профил
- в съответствие с EN 50085-1

TRUNKING BASE MA 130x65

- trunking base from extruded aluminium
- height 130mm, length 2m
- DIN - rail 35mm shape on bottom
- in accordance with EN 50085-1

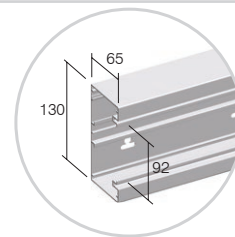

ОСНОВА ЗА КАНАЛ МА 165x65



- RT21ES
- RT21PW

- основа за канал от екструдирани алуминий
- височина 165 mm, дължина 2 m
- DIN – релса 35 mm долен профил
- в съответствие с EN 50085-1

TRUNKING BASE MA 165x65

- trunking base from extruded aluminium
- height 165mm, length 2m
- DIN - rail 35mm shape on bottom
- in accordance with EN 50085-1

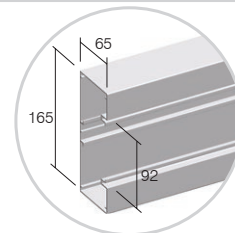

ПРЕДЕН КАПАК МА 92



- RT25ES
- RT25PW

- преден капак от екструдирани алуминий
- височина 92mm, дължина 2 m
- в съответствие с EN 50085-1

FRONT COVER MA 92

- front cover from extruded aluminium
- height 92mm, length 2m
- in accordance with EN 50085-1

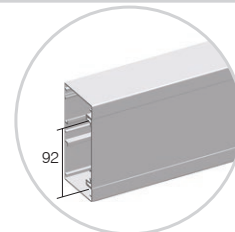

КАБЕЛНА СКАРА МА 43



RT30

- кабелна скара от екструдирани полимер
- дълбочина 43 mm, дължина 2 m
- в съответствие с EN 50085-1

CABLE SHELF MA 43

- cable shelf from extruded polymer
- depth 43mm, length 2m
- in accordance with EN 50085-1

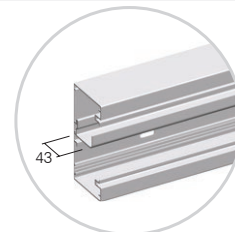

КАБЕЛНА СКАРА МА 43 AL



RT31

- кабелна скара от екструдирани алуминий
- дълбочина 43 mm, дължина 2 m
- в съответствие с EN 50085-1

CABLE SHELF MA 43 AL

- cable shelf from extruded aluminium
- depth 43mm, length 2m
- in accordance with EN 50085-1

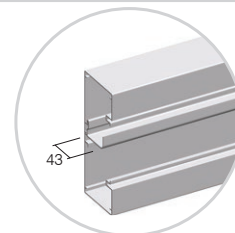

ДВОЙНА КАБЕЛНА СКАРА МА 43 AL



RT32

- двойна кабелна скара от екструдирани алуминий
- дълбочина 43 mm, дължина 2 m
- в съответствие с EN 50085-1

CABLE SHELF MA 43 AL DOUBLE

- double cable shelf from extruded aluminium
- depth 43mm, length 2m
- in accordance with EN 50085-1

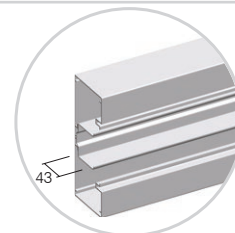

TRUNKING SYSTEM ALUMINIUM

КРАЕН ЕЛЕМЕНТ МА 130x65



- RT35ES
- RT35PW

- краен елемент от полимер
- височина 130 mm
- в съответствие с EN 50085-1

STOP END MA 130x65

- stop end element from polymer
- height 130mm
- in accordance with EN 50085-1

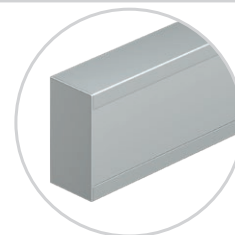

КРАЕН ЕЛЕМЕНТ МА 165x65



- RT36ES
- RT36PW

- метален краен елемент
- височина 165mm
- в съответствие с EN 50085-1

STOP END MA 165x65

- stop end element from metal
- height 165mm
- in accordance with EN 50085-1

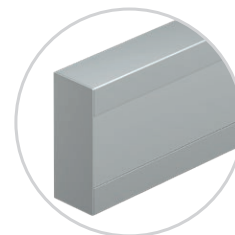

КОМПЛЕКТ СЪЕДИНИТЕЛЕН ЕЛЕМЕНТ МА 65



RT38

- съединителен елемент от полимер
- комплектът съдържа два елемента и винтове
- в съответствие с EN 50085-1

SET JOINING PIECE MA 65

- joining piece from polymer
- set contains two pieces and screws
- in accordance with EN 50085-1

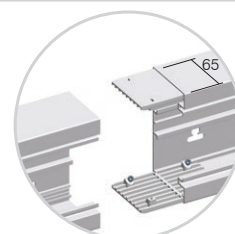

УНИВЕРСАЛЕН ТЪГЛОВ ЕЛЕМЕНТ МА 130x65



- RT40ES
- RT40PW

- универсален ъглов елемент
- височина 130 mm
- в съответствие с EN 50085-1

UNIVERSAL CORNER MA 130x65

- universal corner element
- height 130mm
- in accordance with EN 50085-1



УНИВЕРСАЛЕН ТЪГЛОВ ЕЛЕМЕНТ МА 165x65



- RT41ES
- RT41PW

- универсален ъглов елемент
- височина 165mm
- в съответствие с EN 50085-1

UNIVERSAL CORNER MA 165x65

- universal corner element
- height 165mm
- in accordance with EN 50085-1



ЗАЗЕМИТЕЛЕН ЕЛЕМЕНТ МА 2 x А6.3



RT42

- заземителен елемент за заземяване на основата на канала и предния капак
- в съответствие с EN 50085-1

EARTHING PIECE MA 2x A6.3

- earthing piece for earthing of trunking base and front cover
- in accordance with EN 50085-1

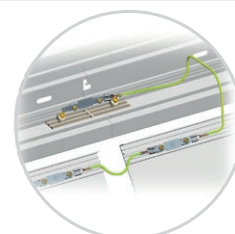

L-КОЛЯНО МА 130x65 / 130



- RT43ES
- RT43PW

- универсален елемент- L-коляно от алуминий
- височина 130 mm, дължина 400 mm
- свързване с МА 130x65
- в съответствие с EN 50085-1

L-BEND MA 130x65 / 130

- universal L bend element from aluminium
- height 130mm, length 400mm
- connection on MA 130x65
- in accordance with EN 50085-1

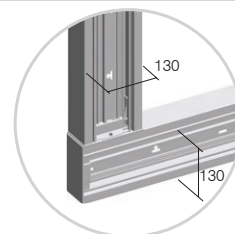

L-КОЛЯНО MA 165x65 / 130



- RT44ES
- RT44PW

- универсален елемент- L-коляно от алуминий
- височина 165 mm, дължина 400 mm
- свързване с MA 130x65
- в съответствие с EN 50085-1

L-BEND MA 165x65 / 130

- universal L bend element from aluminium
- height 165mm, length 400mm
- connection on MA 130x65
- in accordance with EN 50085-1

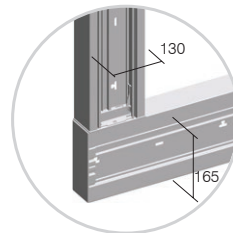

L-КОЛЯНО MA 165x65 / 165



- RT47ES
- RT47PW

- универсален елемент- L-коляно от алуминий
- височина 165 mm, дължина 400 mm
- свързване с MA 165x65
- в съответствие с EN 50085-1

L-BEND MA 165x65 / 165

- universal L bend element from aluminium
- height 165mm, length 400mm
- connection on MA 165x65
- in accordance with EN 50085-1

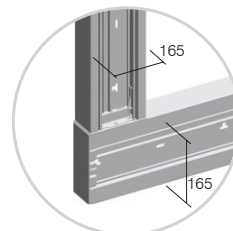

T-КОЛЯНО MA 130x65 / 130



- RT45ES
- RT45PW

- универсален елемент- T-коляно от алуминий
- височина 130 mm, дължина 400 mm
- свързване с MA 130x65
- в съответствие с EN 50085-1

T-BEND MA 130x65 / 130

- universal T bend element from aluminium
- height 130mm, length 400mm
- connection on MA 130x65
- in accordance with EN 50085-1

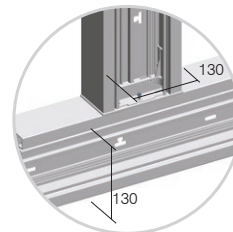

T-КОЛЯНО MA 165x65 / 130

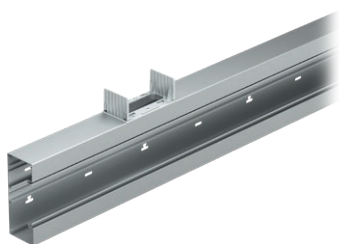

- RT46ES
- RT46PW

- универсален елемент- T-коляно от алуминий
- височина 165 mm, дължина 400 mm
- свързване с MA 130x65
- в съответствие с EN 50085-1

T-BEND MA 165x65 / 130

- universal T bend element from aluminium
- height 165mm, length 400mm
- connection on MA 130x65
- in accordance with EN 50085-1

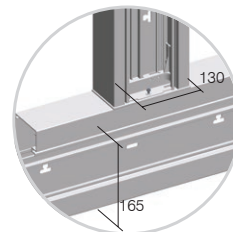

T-КОЛЯНО MA 165x65 / 165

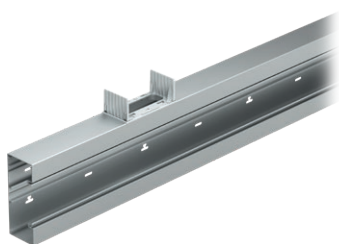

- RT48ES
- RT48PW

- универсален елемент- T-коляно от алуминий
- височина 165 mm, дължина 400 mm
- свързване с MA 165x65
- в съответствие с EN 50085-1

T-BEND MA 165x65 / 165

- universal T bend element from aluminium
- height 165mm, length 400mm
- connection on MA 165x65
- in accordance with EN 50085-1

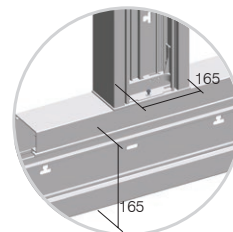

каналите MA се основават на модулна система за 2M, 4M или 7M комбинации от елементи
 MA trunking is based on modular system making 2M, 4M or 7M combinations of elements

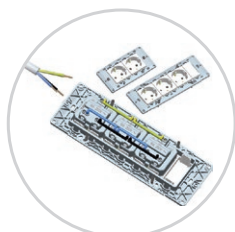

В Modul ние предоставяме специални елементи за бърз монтаж
 In Modul we provide special elements for quick installation

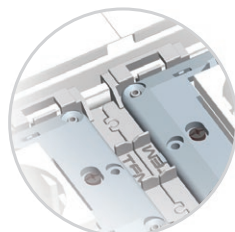

С Adapter MA се предоставя точно позициониране без излишни усилия
 With Adapter MA exact positioning without extra effort is provided

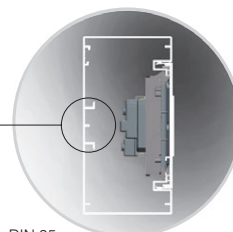

Монтаж без конзола означава повече място за кабели, DIN-релса базов профил EN-60715
 Mounted without box means more space for cables, DIN-rail base shape EN-60715

TRUNKING SYSTEM ALUMINIUM



ЕДИНИЧНА ЗАКРЕПВАЩА ПЛАСТИНА MA 130x65



- RT50ES
- RT50PW

- закрепваща пластина за закрепване на основа за канал MA130 върху под и/или на таван
- в съответствие с EN 50085-1

FIXING PLATE MA SINGLE 130x65

- fixing plate for fixing trunking base MA130 on the floor and/or on the ceiling
- in accordance with EN 50085-1



- RT51ES
- RT51PW

ДВОЙНА ЗАКРЕПВАЩА ПЛАСТИНА MA 130x65

- закрепваща пластина за закрепване на две основи за канал MA130 върху под и/или на таван
- в съответствие с EN 50085-1

FIXING PLATE MA DOUBLE 130x65

- fixing plate for fixing two trunking bases MA130 on the floor and/or on the ceiling
- in accordance with EN 50085-1



СЕРВИЗНА КОЛОНА MA 130x65x500



- RT52ES
- RT52PW

- сервисна колона MA
- височина 500 mm
- включена в доставката монтажна рамка 7M
- в съответствие с EN 50085-1

SERVICE POST MA 130x65x500

- service post MA
- height 500mm
- mounting frame 7M included
- in accordance with EN 50085-1



ДВОЙНА СЕРВИЗНА КОЛОНА MA 130x130x500

- RT53ES
- RT53PW

- двойна сервисна колона MA
- височина 500 mm
- включена в доставката монтажни рамки 7M
- в съответствие с EN 50085-1

SERVICE POST MA DOUBLE 130x130x500

- service post MA double
- height 500mm
- mounting frames 7M included
- in accordance with EN 50085-1

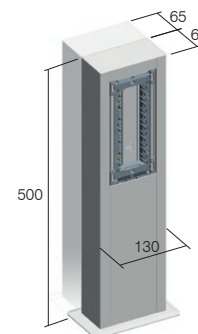

Сечение на кабел / Cable intersection mm ²	Напречно сечение на кабелите / Cable cross-section (mm ²)				
	1 проводник / 1 wire	2 проводника / 2 wires	3 проводника / 3 wires	4 проводника / 4 wires	5 проводника / 5 wires
1,5	44	111	121	144	169
2,5	49	133	157	169	211
4	58	169	183	211	256
6	68	196	225	256	307

Вместимост на канал за кабели / Trunk capacity				
Канал за кабели / Trunk	MA 130x65	MA 130x65	MA 165x65	MA 130x65
	празен / empty	с ключове и контакти Modul / with Modul switches and sockets	празен / empty	с ключове и контакти Modul / with Modul switches and sockets
вместимост / capacity	7600 mm ²	5500 mm ²	9900 mm ²	7800 mm ²
max ø	54 mm	2x42 mm	54 mm	2x42 mm

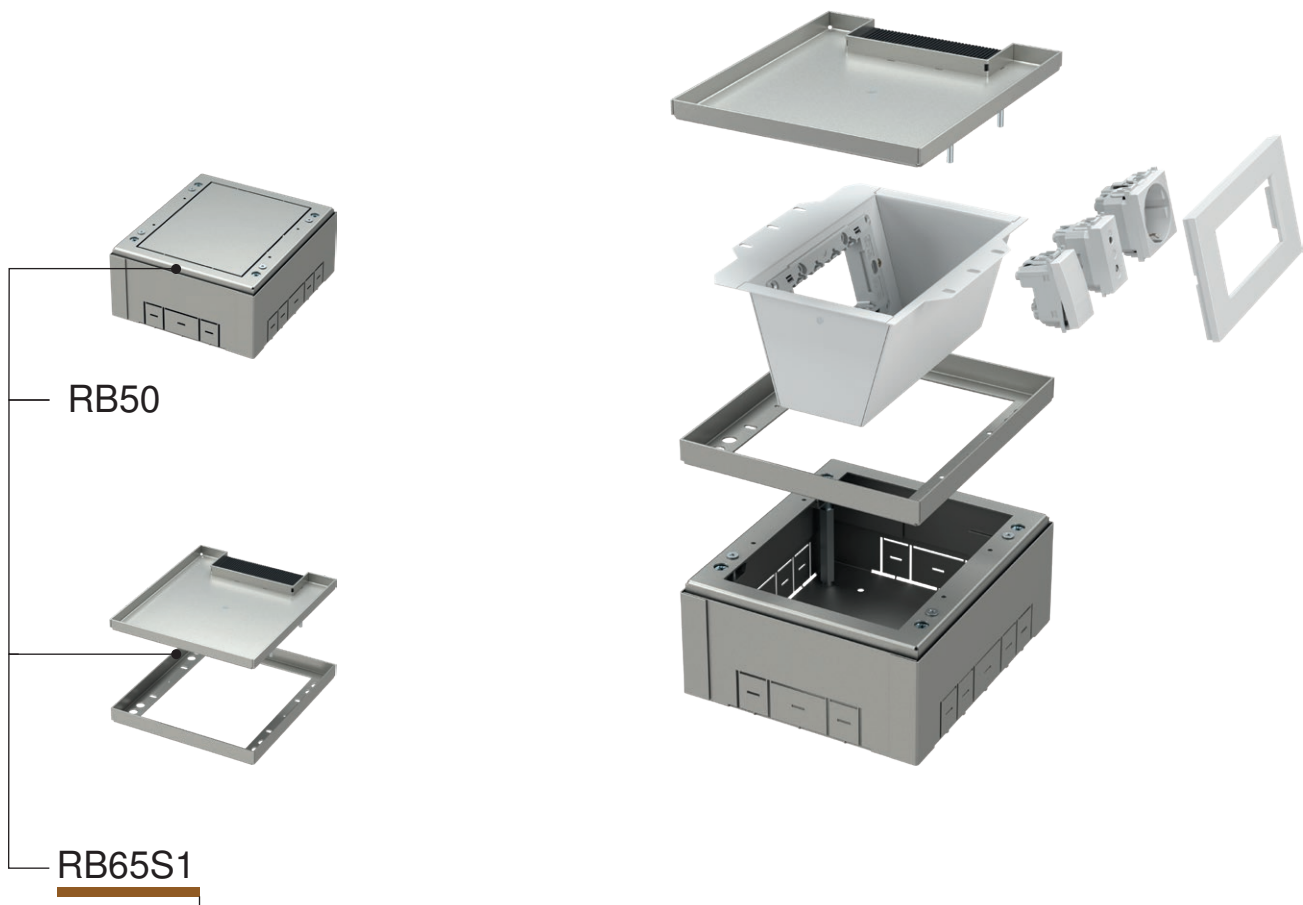

тип type	описание description	технически данни technical data
RB50	ОСНОВА ЗА ПОДОВА КОНЗОЛА FLOOR BOX BASE	4M
RB65S1	КАПАК ЗА ПОДОВА РАЗПРЕДЕЛИТЕЛНА КУТИЯ FLOOR DISTRIBUTION BOX COVER	4M
RB60	ВЛОЖКА ЗА ПОДОВА РАЗПРЕДЕЛИТЕЛНА КУТИЯ INSERT FOR FLOOR DISTRIBUTION BOX	4M
·	·	·
·	·	·

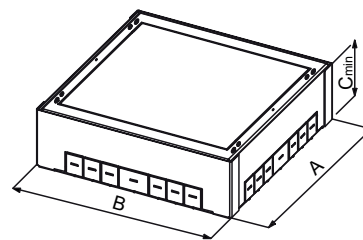
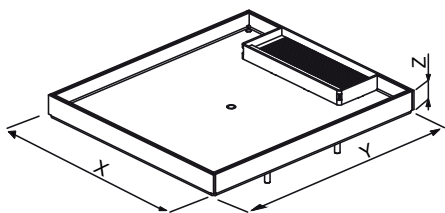

	RB65S1	RB66S1	RB67S2	RB68S2
X	177	178	265	516,5
Y	200,5	265	265	265
Z	17,5	17,5	17,5	17,5

	RB50	RB51	RB52	RB53
A	208,5	273	273	273
B	182	182,5	269,5	521
C min	83	83	83	83

ÎNĂLȚIMEA COMPOZITIEI MIN / MAX
ASSEMBLY HEIGHT MIN / MAX



F L O O R B O X E S M T

ОСНОВА ЗА ПОДОВА КОНЗОЛА 4М



RB50

- основа за подова конзола 4 М
- метална, с галванично покритие
- за инсталиране в под и в двоен под
- размери за монтаж 208,5 x 182 мм, дълбочина мин. 83 мм
- регулируема височина 83 – 128 мм
- в съответствие с EN 5005-1 в EN 50085-2-2

FLOOR BOX BASE 4M

- floor box base 4M
- metal, galvanized
- for installation in a floor or double floor
- mounting dimensions 208.5x182mm, min. depth 83mm
- adjustable height 83-128mm
- in accordance with EN 5005-1 and EN 50085-2-2

ВЛОЖКА ЗА ПОДОВА РАЗПРЕДЕЛИТЕЛНА КУТИЯ 4 М



RB60

- вложка за подова конзола 4 М
- метална, бял цвят RAL 9006
- включен МОДУЛ за монтажна рамка 4 М
- в съответствие с EN 5005-1 в EN 50085-2-2

INSERT FOR FLOOR DISTRIBUTION BOX 4M

- insert for floor box 4M
- metal, colour white RAL 9006
- mounting frame MODUL 4M included
- in accordance with EN 5005-1 and EN 50085-2-2

КАПАК ЗА ПОДОВА РАЗПРЕДЕЛИТЕЛНА КУТИЯ 4 М



RB65S1

- капак за подова конзола 4 М
- метална, с галванично покритие
- размери за монтаж 200,5 x 177 мм, дълбочина 17,5 мм
- дебелина на пода до 11,5 мм
- в съответствие с EN 5005-1 в EN 50085-2-2

FLOOR DISTRIBUTION BOX COVER 4M

- floor box cover 4M
- metal, galvanized
- mounting dimensions 200.5x177mm, depth 17.5mm
- floor thickness up to 11.5mm
- in accordance with EN 5005-1 and EN 50085-2-2

ОСНОВА ЗА ПОДОВА КОНЗОЛА 7 М



RB51

- основа за подова конзола 7 М
- метална, с галванично покритие
- за инсталиране в под и в двоен под
- размери за монтаж 273 x 182,5 мм, дълбочина мин. 83 мм
- регулируема височина 83 – 128 мм
- в съответствие с EN 5005-1 в EN 50085-2-2

FLOOR BOX BASE 7M

- floor box base 7M
- metal, galvanized
- for installation in a floor or double floor
- mounting dimensions 273x182.5mm, min. depth 83mm
- adjustable height 83-128mm
- in accordance with EN 5005-1 and EN 50085-2-2

ВЛОЖКА ЗА ПОДОВА РАЗПРЕДЕЛИТЕЛНА КУТИЯ 7 М



RB61

- вложка за подова конзола 7 М
- метална, бял цвят RAL 9006
- включен МОДУЛ за монтажна рамка 7 М
- в съответствие с EN 5005-1 в EN 50085-2-2

INSERT FOR FLOOR DISTRIBUTION BOX 7M

- insert for floor box 7M
- metal, colour white RAL 9006
- mounting frame MODUL 7M included
- in accordance with EN 5005-1 and EN 50085-2-2

КАПАК ЗА ПОДОВА РАЗПРЕДЕЛИТЕЛНА КУТИЯ 7 М

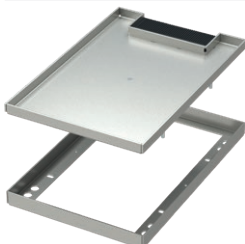

RB66S1

- капак за подова конзола 7 М
- метална, с галванично покритие
- размери за монтаж 265 x 178 мм, дълбочина 17,5 мм
- дебелина на пода до 11,5 мм
- в съответствие с EN 5005-1 в EN 50085-2-2

FLOOR DISTRIBUTION BOX COVER 7M

- floor box cover 7M
- metal, galvanized
- mounting dimensions 265x178mm, depth 17.5mm
- floor thickness up to 11.5mm
- in accordance with EN 5005-1 and EN 50085-2-2

ОСНОВА ЗА ПОДОВА КОНЗОЛА 2 X 7 М

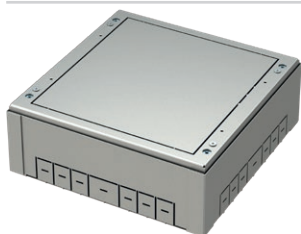

RB52

- основа за подова конзола 2 X 7 М
- метална, с галванично покритие
- за инсталиране в под и в двоен под
- размери за монтаж 273 x 269,5 мм, дълбочина мин. 83 мм
- регулируема височина 83 – 128 мм
- в съответствие с EN 5005-1 в EN 50085-2-2

FLOOR BOX BASE 2X7M

- floor box base 2X7M
- metal, galvanized
- for installation in a floor or double floor
- mounting dimensions 273x269.5mm, min. depth 83mm
- adjustable height 83-128mm
- in accordance with EN 5005-1 and EN 50085-2-2

ВЛОЖКА ЗА ПОДОВА РАЗПРЕДЕЛИТЕЛНА КУТИЯ 2X7 М



RB62

- вложка за подова конзола 2 x 7 М
- метална, бял цвят RAL 9006
- включен МОДУЛ за монтажни рамки 2x7M
- в съответствие с EN 5005-1 в EN 50085-2-2

INSERT FOR FLOOR DISTRIBUTION BOX 2X7M

- insert for floor box 2x7M
- metal, colour white RAL 9006
- mounting frames MODUL 2x7M included
- in accordance with EN 5005-1 and EN 50085-2-2

КАПАК ЗА ПОДОВА РАЗПРЕДЕЛИТЕЛНА КУТИЯ 2 X 7 М



RB67S2

- капак за подова конзола 2x7 М
- метална, с галванично покритие
- размери за монтаж 265 x 265 мм, дълбочина 17,5 мм
- дебелина на пода до 11,5 мм
- в съответствие с EN 5005-1 в EN 50085-2-2

FLOOR DISTRIBUTION BOX COVER 2X7M

- floor box cover 2x7M
- metal, galvanized
- mounting dimensions 265x265mm, depth 17.5mm
- floor thickness up to 11.5mm
- in accordance with EN 5005-1 and EN 50085-2-2

ОСНОВА ЗА ПОДОВА КОНЗОЛА 4 X 7 М

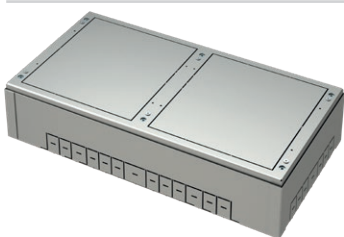

RB53

- основа за подова конзола 4 X 7 М
- метална, с галванично покритие
- за инсталиране в под и в двоен под
- размери за монтаж 273 x 521 мм, дълбочина мин. 83 мм
- регулируема височина 83 – 128 мм
- в съответствие с EN 5005-1 в EN 50085-2-2

FLOOR BOX BASE 4X7M

- floor box base 4X7M
- metal, galvanized
- for installation in a floor or double floor
- mounting dimensions 273x521mm, min. depth 83mm
- adjustable height 83-128mm
- in accordance with EN 5005-1 and EN 50085-2-2

ВЛОЖКА ЗА ПОДОВА РАЗПРЕДЕЛИТЕЛНА КУТИЯ 2X7 М



RB62

- вложка за подова конзола 2 x 7 М
- метална, бял цвят RAL 9006
- включен МОДУЛ за монтажни рамки 2x7M
- в съответствие с EN 5005-1 в EN 50085-2-2

INSERT FOR FLOOR DISTRIBUTION BOX 2X7M

- insert for floor box 2x7M
- metal, colour white RAL 9006
- mounting frames MODUL 2x7M included
- in accordance with EN 5005-1 and EN 50085-2-2

КАПАК ЗА ПОДОВА РАЗПРЕДЕЛИТЕЛНА КУТИЯ 4 X 7 М



RB68S2

- капак за подова конзола 4 x 7 М
- метална, с галванично покритие
- размери за монтаж 265 x 516,5 мм, дълбочина 17,5 мм
- дебелина на пода до 11,5 мм
- в съответствие с EN 5005-1 в EN 50085-2-2

FLOOR DISTRIBUTION BOX COVER 4X7M

- floor box cover 4x7M
- metal, galvanized
- mounting dimensions 265x516.5mm, depth 17.5mm
- floor thickness up to 11.5mm
- in accordance with EN 5005-1 and EN 50085-2-2



RB55S1

тип type	описание description	технически данни technical data
RB55S1	ПОДОВА КОНЗОЛА С КАПАК ЗА ДВОЕН ПОД FLOOR BOX WITH COVER FOR DOUBLE FLOORS	4M
RB60	ВЛОЖКА ЗА ПОДОВА РАЗПРЕДЕЛИТЕЛНА КУТИЯ INSERT FOR FLOOR DISTRIBUTION BOX	4M
⋮	⋮	⋮
⋮	⋮	⋮

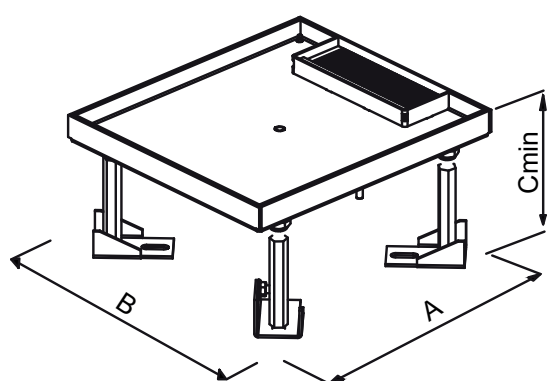

ÎNĂLȚIMEA FINALĂ A PODELEI MIN
FINAL FLOOR HEIGHT: MIN

	RB55S1	RB56S1	RB57S2	RB58S2
A	200,5	265	265	265
B	177	178	265	516,5
C min	100	100	100	100

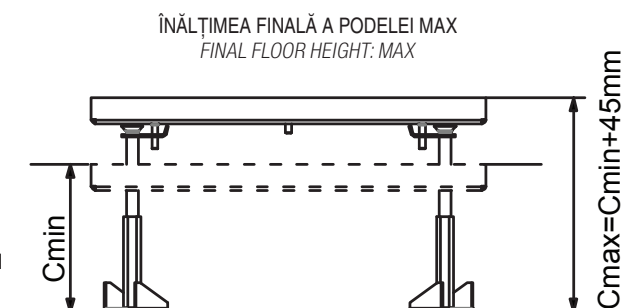

ÎNĂLȚIMEA FINALĂ A PODELEI MAX
FINAL FLOOR HEIGHT: MAX

ПОДОВА КОНЗОЛА С КАПАК ЗА ДВОЕН ПОД 4 М



RB55S1

- основа за подова конзола 4 М
- метална, с галванично покритие
- размери за монтаж 200,5 x 177 мм, дълбочина мин. 100 мм
- регулируема височина 100 – 145 мм
- дебелина на пода до 11,5 мм
- в съответствие с EN 5005-1 в EN 50085-2-2

FLOOR BOX WITH COVER FOR DOUBLE FLOORS 4M

- floor box base 4M
- metal, galvanized
- mounting dimensions 200.5x177mm, min. depth 100mm
- adjustable height 100-145mm
- floor thickness up to 11.5mm
- in accordance with EN 5005-1 and EN 50085-2-2

ВЛОЖКА ЗА ПОДОВА РАЗПРЕДЕЛИТЕЛНА КУТИЯ 4 М



RB60

- вложка за подова конзола 4 М
- метална, бял цвят RAL 9006
- включен МОДУЛ за монтажна рамка 4 М
- в съответствие с EN 5005-1 в EN 50085-2-2

INSERT FOR FLOOR DISTRIBUTION BOX 4M

- insert for floor box 4M
- metal, colour white RAL 9006
- mounting frame MODUL 4M included
- in accordance with EN 5005-1 and EN 50085-2-2

ПОДОВА КОНЗОЛА С КАПАК ЗА ДВОЕН ПОД 7 М



RB56S1

- основа за подова конзола 7 М
- метална, с галванично покритие
- размери за монтаж 265 x 178 мм, дълбочина мин. 100 мм
- регулируема височина 100 – 145 мм
- дебелина на пода до 11,5 мм
- в съответствие с EN 5005-1 в EN 50085-2-2

FLOOR BOX WITH COVER FOR DOUBLE FLOORS 7M

- floor box base 7M
- metal, galvanized
- mounting dimensions 265x178mm, min. depth 100mm
- adjustable height 100-145mm
- floor thickness up to 11.5mm
- in accordance with EN 5005-1 and EN 50085-2-2

ВЛОЖКА ЗА ПОДОВА РАЗПРЕДЕЛИТЕЛНА КУТИЯ 7 М



RB61

- вложка за подова конзола 7 М
- метална, бял цвят RAL 9006
- включен МОДУЛ за монтажна рамка 7 М
- в съответствие с EN 5005-1 в EN 50085-2-2

INSERT FOR FLOOR DISTRIBUTION BOX 7M

- insert for floor box 7M
- metal, colour white RAL 9006
- mounting frame MODUL 7M included
- in accordance with EN 5005-1 and EN 50085-2-2

ПОДОВА КОНЗОЛА С КАПАК ЗА ДВОЕН ПОД 2 X 7 М



RB57S2

- основа за подова конзола 2 X 7 М
- метална, с галванично покритие
- размери за монтаж 265 x 265 мм, дълбочина мин. 100 мм
- регулируема височина 100 – 145 мм
- дебелина на пода до 11,5 мм
- в съответствие с EN 5005-1 в EN 50085-2-2

FLOOR BOX WITH COVER FOR DOUBLE FLOORS 2X7M

- floor box base 2x7M
- metal, galvanized
- mounting dimensions 265x265mm, min. depth 100mm
- adjustable height 100-145mm
- floor thickness up to 11.5mm
- in accordance with EN 5005-1 and EN 50085-2-2

ВЛОЖКА ЗА ПОДОВА РАЗПРЕДЕЛИТЕЛНА КУТИЯ 2X7 М



RB62

- вложка за подова конзола 2 x 7 М
- метална, бял цвят RAL 9006
- включен МОДУЛ за монтажни рамки 2x7M
- в съответствие с EN 5005-1 в EN 50085-2-2

INSERT FOR FLOOR DISTRIBUTION BOX 2X7M

- insert for floor box 2x7M
- metal, colour white RAL 9006
- mounting frames MODUL 2x7M included
- in accordance with EN 5005-1 and EN 50085-2-2

ПОДОВА КОНЗОЛА С КАПАК ЗА ДВОЕН ПОД 4 X 7 М



RB58S2

- основа за подова конзола 4 X 7 М
- метална, с галванично покритие
- размери за монтаж 265 x 516,5 мм, дълбочина мин. 100 мм
- регулируема височина 100 – 145 мм
- дебелина на пода до 11,5 мм
- в съответствие с EN 5005-1 в EN 50085-2-2

FLOOR BOX WITH COVER FOR DOUBLE FLOORS 4X7M

- floor box base 4x7M
- metal, galvanized
- mounting dimensions 265x516.5mm, min. depth 100mm
- adjustable height 100-145mm
- floor thickness up to 11.5mm
- in accordance with EN 5005-1 and EN 50085-2-2

ВЛОЖКА ЗА ПОДОВА РАЗПРЕДЕЛИТЕЛНА КУТИЯ 2X7 М



RB62

- вложка за подова конзола 2 x 7 М
- метална, бял цвят RAL 9006
- включен МОДУЛ за монтажни рамки 2x7M
- в съответствие с EN 5005-1 в EN 50085-2-2

INSERT FOR FLOOR DISTRIBUTION BOX 2X7M

- insert for floor box 2x7M
- metal, colour white RAL 9006
- mounting frames MODUL 2x7M included
- in accordance with EN 5005-1 and EN 50085-2-2

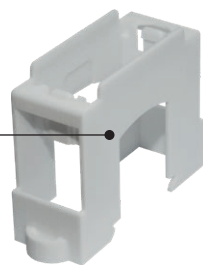
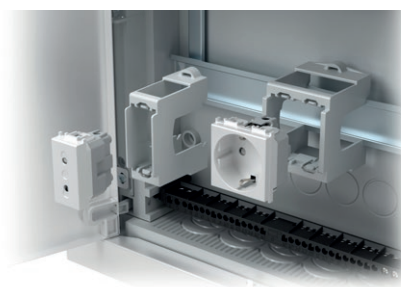
RB10

тип type	описание description	технически данни technical data
RB10	АДАПТЕР ЗА DIN РЕЛСА ADAPTER FOR DIN RAIL	35mm 1M
RB11	АДАПТЕР ЗА DIN РЕЛСА ADAPTER FOR DIN RAIL	35mm 2M
·	РАЗПРЕДЕЛИТЕЛНА КУТИЯ	·
·	·	·
·	·	·

АДАПТЕР ЗА DIN РЕЛСА 35 mm 1M

RB10

- адаптер MODUL 1M
- за DIN релса 35 mm
- в съответствие с EN 50022

ADAPTER FOR DIN RAIL 35mm 1M

- adapter MODUL 1M
- for DIN rail 35mm
- in accordance with EN 50022

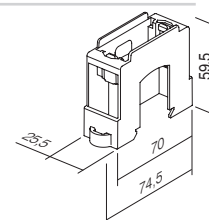

АДАПТЕР ЗА DIN РЕЛСА 35 mm 2M

RB11

- адаптер MODUL 2M
- за DIN релса 35 mm
- в съответствие с EN 50022

ADAPTER FOR DIN RAIL 35mm 2M

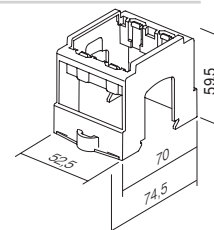
- adapter MODUL 2M
- for DIN rail 35mm
- in accordance with EN 50022



TEM

SWITCH
LOGIQ



LOGIQ

LOGIQ
FLAT



LOGIQ
BOLD



LOGIQ
PRIME



LOGIQ

FLAT





LOGIQ

B O L D





LOGIQ

PRIME



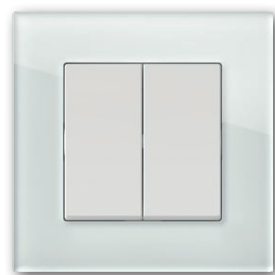

Произведени за всяко пространство

Универсалните линии ключове оставят отпечатъка си в модерните бизнес среди или в по-домашните топли жилищни помещения. За всяко ваше желание групата ключове LOGIQ ви предлага лесно и логично решение.

Made for every room

The switches have universal lines that make a mark in both modern work environments and cosy, comfortable living spaces. The LOGIQ family of switches offers a simple and logical solution for your every wish.

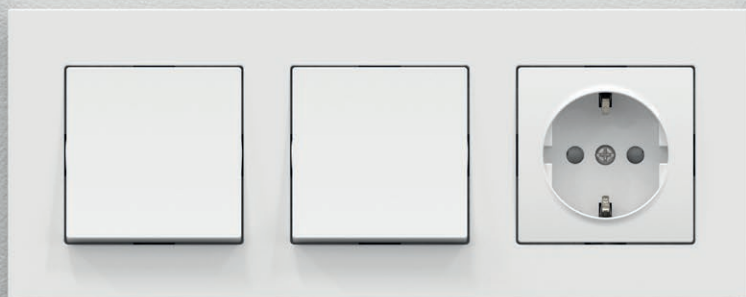

LOGIQ
FLAT



LOGIQ
PRIME

Хармония на цветовете за всяко помещение

Групата LOGIQ се отличава с логичен избор на проверени и елегантни цветови нюанси, които клиентите обичат най-много. Не се приспособявайте вие, LOGIQ се приспособява към вас.

Harmony of colours for every room

The LOGIQ family prides itself on its logical range of verified and elegant hues known and loved by our users. Do not compromise, LOGIQ has you covered.

■ черно	<i>black</i>
■ антрацит	<i>anthracite</i>
■ титан	<i>titanium</i>
□ полярно бяло	<i>polar white</i>



LOGIQ
FLAT



LOGIQ
BOLD



LOGIQ
PRIME

Безгранична фантазия

Групата LOGIQ позволява съставянето на произволни комбинации. С цел лесно комбиниране изработихме за вас практично допълнение, което улеснява понижаването на хоризонталните и вертикалните линии. Т.нар. система 55/55 позволява използването на еднакви универсални елементи.

LIMITLESS IMAGINATION

The LOGIQ family allows you to create your own combinations. To make combining simple, we have created a useful system that supports the sequencing of horizontal and vertical lines. The so-called 55/55 system allows you to use the same universal elements every time.



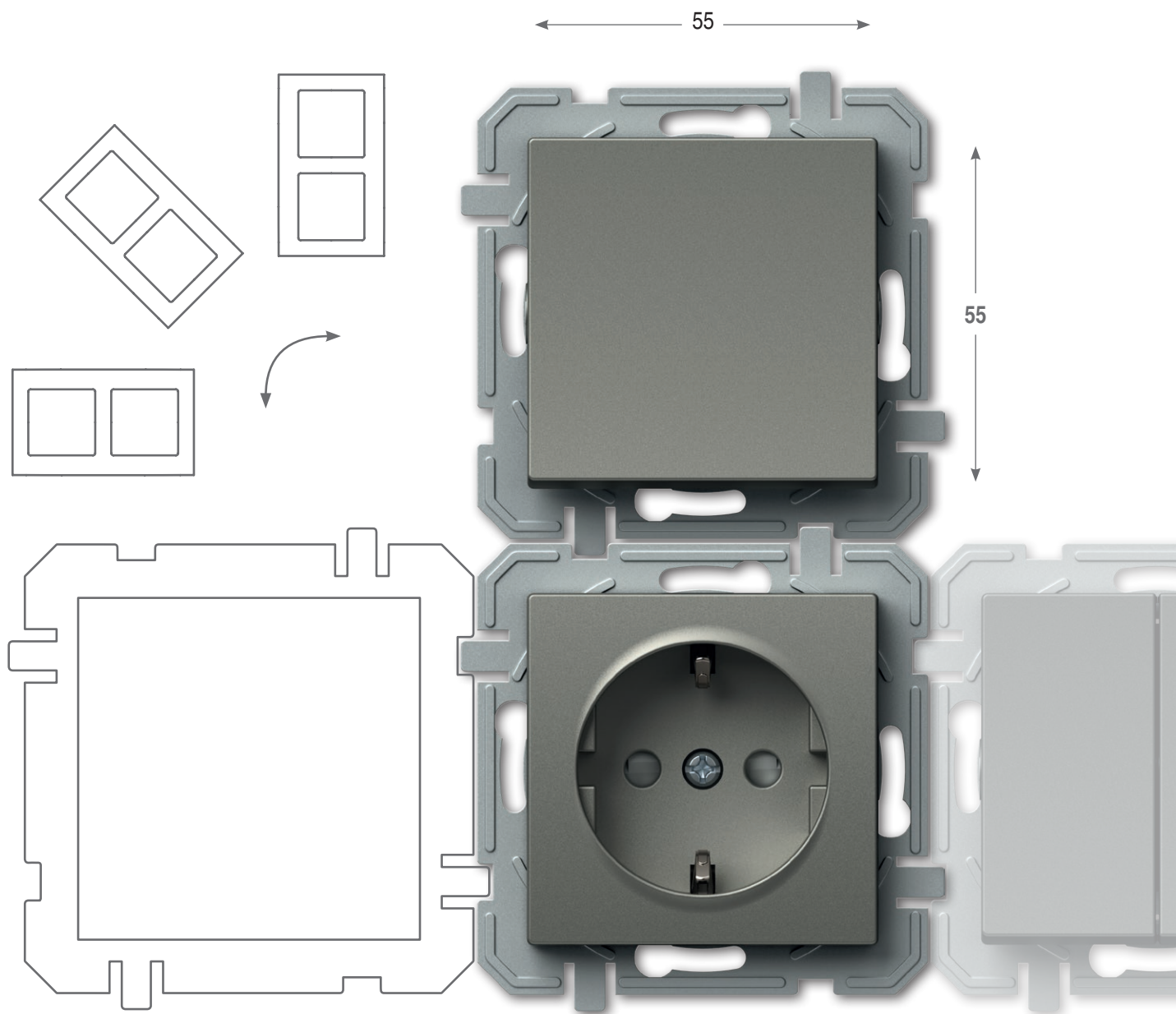

Лесно за най-взискателните

Групата LOGIQ предлага функционални елементи за всяко помещение и цел. Можете да ги използвате отделно или в съчетание. Хоризонтално или вертикално.

Логично.

Simple for the most demanding

The LOGIQ family offers functional elements for every space and purpose. You can use these products individually or in a sequence, horizontally or vertically. Logically.

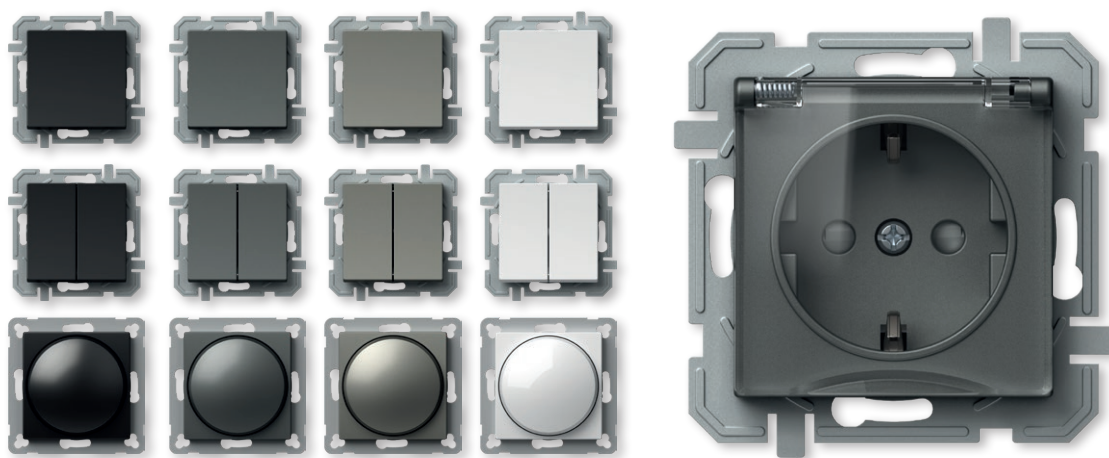

Универсално поставяне на декоративните рамки от трите дизайнерски линии FLAT, BOLD и PRIME.

A universal layout of decorative cover plates in all three design lines – FLAT, BOLD and PRIME.



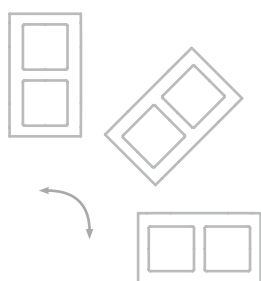

Логичен монтаж

LOGIQ е решение за системата на старндартните кръгли конзоли. С него можете да планиране както обикновени, така и по-сложни инсталации, нови строежи и адаптации. Системата се отличава с контакти без болтове, което ви спестява време при вграждането на елементите.

Logical installation

LOGIQ is a solution for the system of standardized round installations boxes. It can be used for simple as well as more demanding installations, new buildings and adaptations. The system is characterised by plug-in contacts which save time during installation of elements.

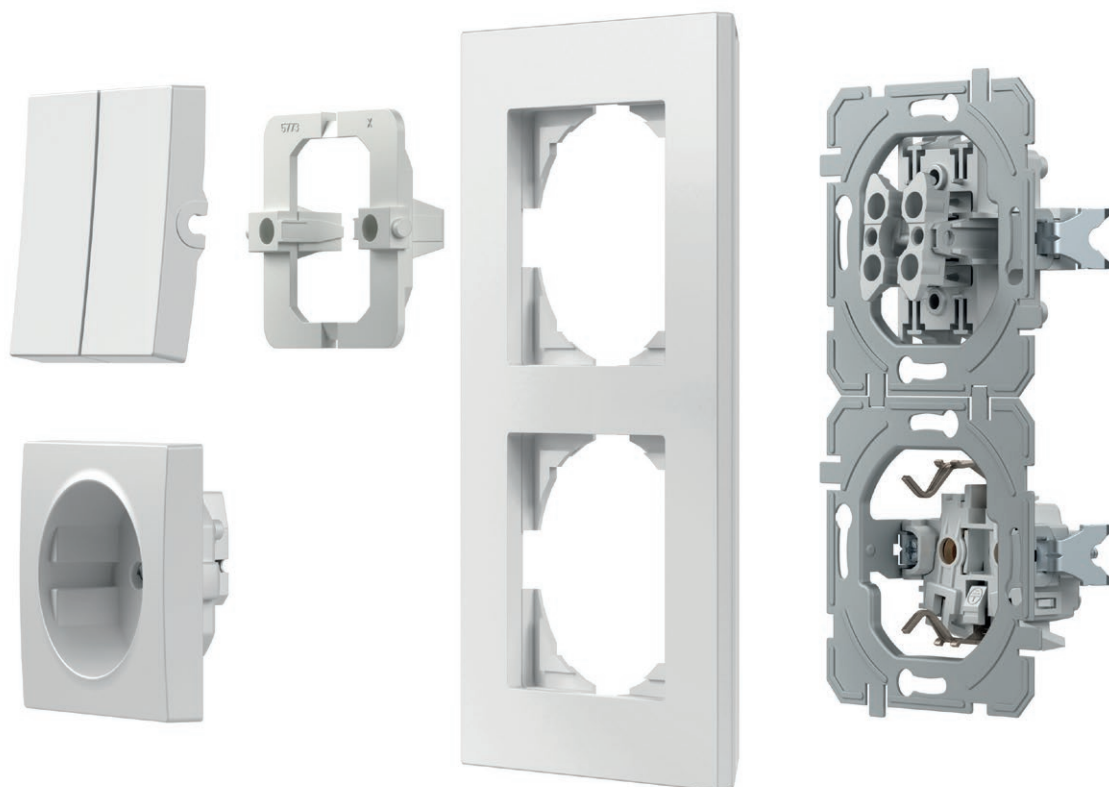

Добре е да знаете

Good to know



Всички контакти са оборудвани за безопасно изключване, което гарантира защитата на контактите, които са под напрежение.

All the sockets are equipped with a safety shutters assuring the protection to live contacts.



Добре обмислената конструкция на ключа позволява и допълнително лесна индикация.

The well-thought-out design of the switch enables the easy integration of the indication, including at a later time.



Надеждността на превключването се гарантира от контакти от сребърна сплав.

Contacts made of silver alloy guarantee safe switching.



Контактите, осъществявани чрез вкарване на проводниците, позволяват бързо и надеждно закрепване на проводниците. Два проводника с различни диаметри може да се свържат към един и същи контакт.

Plug-in contacts enable quick and reliable attachment of wires. Two wires of different diameters can be attached to the same contact.



Закрепващите крачета дават възможност за по-дълбоко закрепване (също така и през керамични плочки и подобни)

Fixing claws enable deeper fixing (also through ceramic tiles, etc.)



Лесните за монтиране инсталационни конзоли ще улеснят работата ви. Правилните дължини са гарантирани.

Easy-fitting installation boxes will make your work easier. Proper lengths are guaranteed.

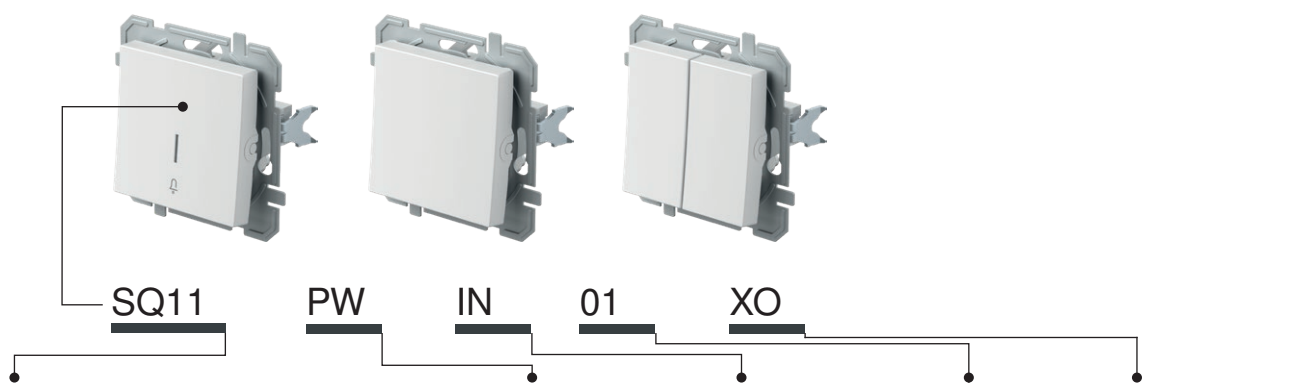

тип type	описание description	технически данни technical data	цвет colour	допълнителна информация 1 optional data 1	допълнителна информация 2 optional data 2	допълнителна информация 3 optional data 3
SQ10	КЛЮЧ 1WAY SWITCH 1WAY	10AX 250V~	□ PW полярно бяло polar white	NT неутрален neutral	🔔 01	XO без декоративен панел without cover plate
SQ11	БУТОН 1WAY PUSH BUTTON 1WAY	10A 250V~	■ TI титан titanium	IN индикатор indicator	🔊 02	
SQ22	КЛЮЧ 2POLE SWITCH 2POLE	16AX 250V~	■ AT антрацит anthracite ■ BK черно black		🔊 03	

КЛЮЧ 1WAY 10AX 250V~

- SQ10PWXO - 10AX 250V~, тип SQ10
- SQ10TIXO - в съответствие с EN 60669-1
- SQ10ATXO - контакти чрез вкарване 1,5-2,5 mm²
- SQ10BKXO

SWITCH 1WAY 10AX 250V~

- 10AX 250V~, type SQ10
- in accordance with EN 60669-1
- plug-in contacts 1.5-2.5mm²

КЛЮЧ 1WAY 10AX 250V~ __ IN

- SQ10PWINXO - IN индикатор, без неонна лампа
- SQ10TIINXO - 10AX 250V~, тип SQ10
- SQ10ATINXO - в съответствие с EN 60669-1
- SQ10BKINXO - контакти чрез вкарване 1,5-2,5 mm²

SWITCH 1WAY 10AX 250V~ __ IN

- IN indicator, without neon lamp
- 10AX 250V~, type SQ10
- in accordance with EN 60669-1
- plug-in contacts 1.5-2.5mm²

БУТОН 1WAY 10A 250V~

- SQ11PWXO - 10A 250V~, тип SQ11
- SQ11TIXO - в съответствие с EN 60669-1
- SQ11ATXO - контакти чрез вкарване 1,5-2,5 mm²
- SQ11BKXO

PUSH BUTTON 1WAY 10A 250V~

- 10A 250V~, type SQ11
- in accordance with EN 60669-1
- plug-in contacts 1.5-2.5mm²

БУТОН 1WAY 10A 250V~ __ IN 01

- SQ11PWIN01XO - IN 01 звънчев индикатор, без неонна лампа
- SQ11TIIN01XO - 10A 250V~, тип SQ11
- SQ11ATIN01XO - в съответствие с EN 60669-1
- SQ11BKIN01XO - контакти чрез вкарване 1,5-2,5 mm²

PUSH BUTTON 1WAY 10A 250V~ __ IN 01

- IN 01 indicator bell, without neon lamp
- 10A 250V~, type SQ11
- in accordance with EN 60669-1
- plug-in contacts 1.5-2.5mm²

S W I T C H E S S Q

БУТОН 1WAY 10A 250V~ __ IN 02



- SQ11PWIN02XO
- SQ11TIIN02XO
- SQ11ATIN02XO
- SQ11BKIN02XO

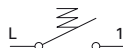

- IN 02 светлинен индикатор, без неонева лампа
- 10A 250V~, тип SQ11
- в съответствие с EN 60669-1
- контакти чрез вкарване 1,5-2,5 mm²

PUSH BUTTON 1WAY 10A 250V~ __ IN 02

- IN 02 indicator light, without neon lamp
- 10A 250V~, type SQ11
- in accordance with EN 60669-1
- plug-in contacts 1.5-2.5mm²



БУТОН 1WAY 10A 250V~ __ IL



- SQ11PWILXO
- SQ11TIILXO
- SQ11ATILXO
- SQ11BKILXO

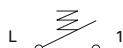

- IL панел с надпис
- 10A 250V~, тип SQ11
- в съответствие с EN 60669-1
- контакти чрез вкарване 1,5 - 2,5 mm²

PUSH BUTTON 1WAY 10A 250V~ __ IL

- IL inscription plate
- 10A 250V~, type SQ11
- in accordance with EN 60669-1
- plug-in contacts 1.5-2.5mm²



КЛЮЧ 2POLE 16AX 250V~ __ IN 03



- SQ22PWIN03XO
- SQ22TIIN03XO
- SQ22ATIN03XO
- SQ22BKIN03XO

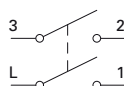

- IN 03 неутрален 0-1, без неонева лампа
- 16AX 250V~, тип SQ22
- в съответствие с EN 60669-1
- винтови контакти 1,5-2,5 mm²

SWITCH 2POLE 16AX 250V~ __ IN 03

- IN 03 neutral 0-1, without neon lamp
- 16AX 250V~, type SQ22
- in accordance with EN 60669-1
- screw contacts 1.5-2.5mm²



КЛЮЧ 2GANG-1WAY 10AX 250V~



- SQ50PWXO
- SQ50TIXO
- SQ50ATXO
- SQ50BKXO

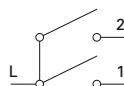

- 10AX 250V~, тип SQ50
- в съответствие с EN 60669-1
- контакти чрез вкарване 1,5-2,5 mm²

SWITCH 2GANG-1WAY 10AX 250V~

- 10AX 250V~, type SQ50
- in accordance with EN 60669-1
- plug-in contacts 1.5-2.5mm²



БУТОН 2GANG-1WAY 10A 250V~



- SQ51PWXO
- SQ51TIXO
- SQ51ATXO
- SQ51BKXO

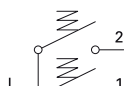

- 10A 250V~, тип SQ51
- в съответствие с EN 60669-1
- контакти чрез вкарване 1,5-2,5 mm²

PUSH BUTTON 2GANG-1WAY 10A 250V~

- 10A 250V~, type SQ51
- in accordance with EN 60669-1
- plug-in contacts 1.5-2.5mm²



КЛЮЧ ЗА ЩОРИ 10AX 250V~ __ NT 09



- SQ52PWNT09XO
- SQ52TINT09XO
- SQ52ATNT09XO
- SQ52BKNT09XO



- NT 09 неутрално положение – нагоре-надолу
- 10AX 250V~, тип SQ52
- в съответствие с EN 60669-1
- контакти чрез вкарване 1,5-2,5 mm²
- с механична блокировка

SWITCH SHUTTERS 10AX 250V~ __ NT 09

- NT 09 neutral up-down
- 10AX 250V~, type SQ52
- in accordance with EN 60669-1
- plug-in contacts 1.5-2.5mm²
- with mechanical interblock



БУТОН ЗА ЩОРИ 10A 250V~ __ NT 09



- SQ53PWNT09XO
- SQ53TINT09XO
- SQ53ATNT09XO
- SQ53BKNT09XO

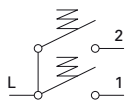

- NT 09 неутрално положение – нагоре-надолу
- 10A 250V~, тип SQ53
- в съответствие с EN 60669-1
- контакти чрез вкарване 1,5-2,5 mm²
- с механична блокировка



PUSH BUTTON SHUTTERS 10A 250V~ __ NT 09

- NT 09 neutral up-down
- 10A 250V~, type SQ53
- in accordance with EN 60669-1
- plug-in contacts 1.5-2.5mm²
- with mechanical interblock

КЛЮЧ 2WAY 10AX 250V~



- SQ60PWXO
- SQ60TIXO
- SQ60ATXO
- SQ60BKXO

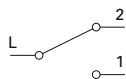

- 10AX 250V~, тип SQ60
- в съответствие с EN 60669-1
- контакти чрез вкарване 1,5-2,5 mm²

SWITCH 2WAY 10AX 250V~

- 10AX 250V~, type SQ60
- in accordance with EN 60669-1
- plug-in contacts 1.5-2.5mm²



КЛЮЧ 2WAY 10AX 250V~_IN



- SQ60PWINXO
- SQ60TIINXO
- SQ60ATINXO
- SQ60BKINXO

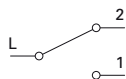

- IN индикатор, без неонна лампа
- 10AX 250V~, тип SQ60
- в съответствие с EN 60669-1
- контакти чрез вкарване 1,5-2,5 mm²

SWITCH 2WAY 10AX 250V~_IN

- IN indicator, without neon lamp
- 10AX 250V~, type SQ60
- in accordance with EN 60669-1
- plug-in contacts 1.5-2.5mm²



КЛЮЧ 2WAY 10AX 250V~_IN 02



- SQ60PWIN02XO
- SQ60TIIN02XO
- SQ60ATIN02XO
- SQ60BKIN02XO

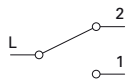

- IN 02 светлинен индикатор, без неонна лампа
- 10AX 250V~, тип SQ60
- в съответствие с EN 60669-1
- контакти чрез вкарване 1,5-2,5 mm²

SWITCH 2WAY 10AX 250V~_IN 02

- IN 02 indicator light, without neon lamp
- 10AX 250V~, type SQ60
- in accordance with EN 60669-1
- plug-in contacts 1.5-2.5mm²



NEW

NEW

ДВОЕН КЛЮЧ 2WAY 10AX 250V~



- SQ63PWXO
- SQ63TIXO
- SQ63ATXO
- SQ63BKXO

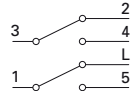

- 10AX 250V~, тип SQ63
- в съответствие с EN 60669-1
- контакти чрез вкарване 1,5-2,5 mm²

SWITCH DOUBLE 2WAY 10AX 250V~
 - 10AX 250V~, type SQ63
 - in accordance with EN 60669-1
 - plug-in contacts 1.5-2.5mm²



КРЪСТАТ КЛЮЧ 10AX 250V~



- SQ70PWXO
- SQ70TIXO
- SQ70ATXO
- SQ70BKXO



- 10AX 250V~, тип SQ70
- в съответствие с EN 60669-1
- контакти чрез вкарване 1,5-2,5 mm²

SWITCH INTERMEDIATE 10AX 250V~
 - 10AX 250V~, type SQ70
 - in accordance with EN 60669-1
 - plug-in contacts 1.5-2.5mm²



SQ10
SQ11

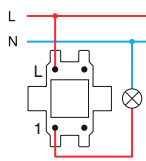

SQ22

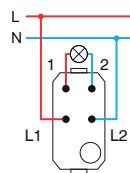

SQ50
SQ51

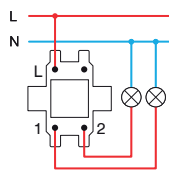

SQ52
SQ53

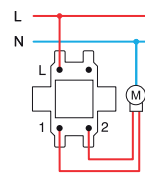

SQ60+SQ60

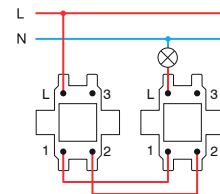

SQ63+SQ63

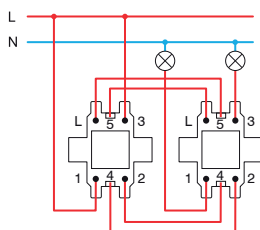

SQ60+SQ70+SQ60

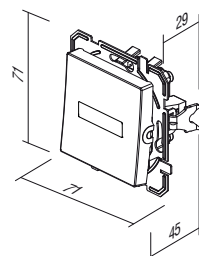
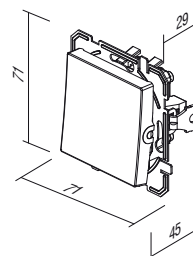
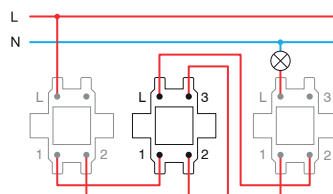

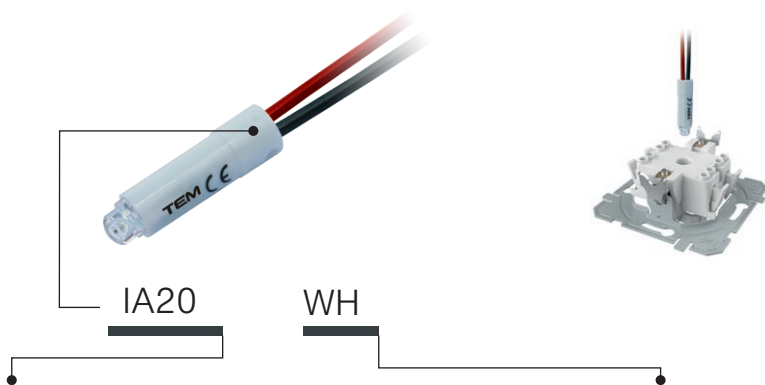

тип type	описание description	технически данни technical data	цвет colour
IA10	НЕОНОВА ЛАМПА NEON LAMP	230V~ 0,34W	<input type="checkbox"/> WH бяло white
IA20	СВЕТОДИОДНА СИГНАЛИЗАЦИЯ LED SIGNALLING UNIT	230V~ 0,40W	<input checked="" type="checkbox"/> BL синьо blue
IA21	СВЕТОДИОДНА СИГНАЛИЗАЦИЯ LED SIGNALLING UNIT	24V AC/DC 0,20W	<input checked="" type="checkbox"/> RD червено red
.	.	.	<input checked="" type="checkbox"/> GR зелено green
.	.	.	<input checked="" type="checkbox"/> OR оранжево orange

НЕОНОВА ЛАМПА 230V~ 0,34W

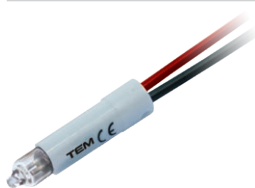

IA10OR

- за индикиране, сигнализация или постоянна сигнализация;
- в съчетание с бутон с индикатор

NEON LAMP 230V~ 0,34W

- for indication, signalling or permanent signalling
- in combination with a button featuring an indicator

СВЕТОДИОДНА СИГНАЛИЗАЦИЯ 230V AC/DC 0,40W

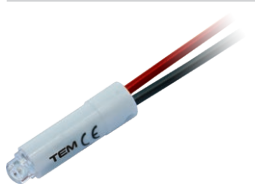

IA20WH
 IA20GR
 IA20RD
 IA20BL

- за индикиране, сигнализация или постоянна сигнализация;
- в съчетание с бутон с индикатор

LED SIGNALLING UNIT 230V AC/DC 0,40W

- for indication, signalling or permanent signalling
- in combination with a button featuring an indicator

СВЕТОДИОДНА СИГНАЛИЗАЦИЯ 24V AC/DC 0,20W

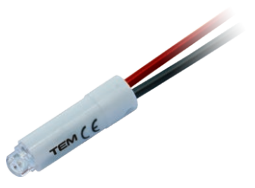

IA21WH
 IA21RD

- за индикиране, сигнализация или постоянна сигнализация;
- в съчетание с бутон с индикатор

LED SIGNALLING UNIT 24V AC/DC 0,20W

- for indication, signalling or permanent signalling
- in combination with a button featuring an indicator

СВЕТОДИОДНА СИГНАЛИЗАЦИЯ 12V AC/DC 0,10W

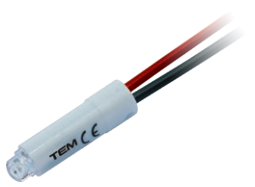

IA22WH
 IA22RD

- за индикиране, сигнализация или постоянна сигнализация;
- в съчетание с бутон с индикатор

LED SIGNALLING UNIT 12V AC/DC 0,10W

- for indication, signalling or permanent signalling
- in combination with a button featuring an indicator

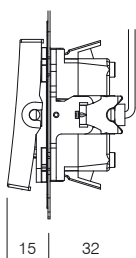

S I G N A L I Z A T I O N I A

Индикация
Indication

*Сигнализация
Signalization

Постоянна сигнализация
Permanent signalling

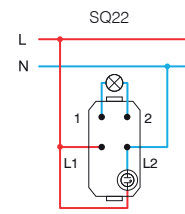
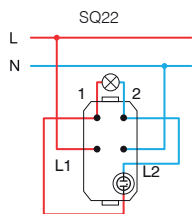
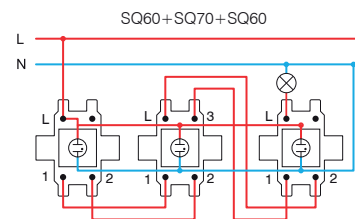
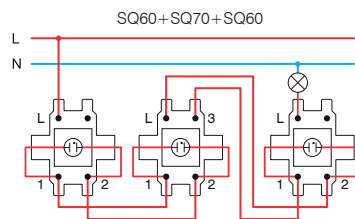
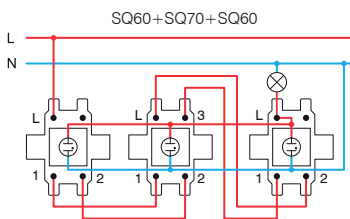
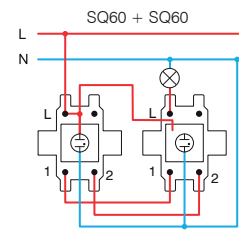
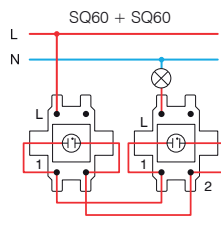
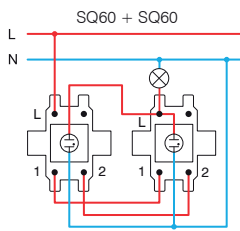
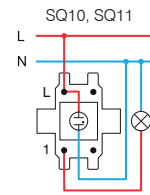
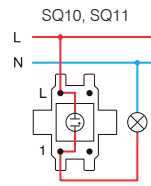
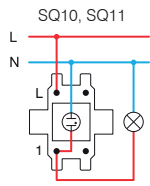

* връзките не са подходящи за енергоспестяващи крушки (CFL, LED) /
the connections are not suitable for energy-saving bulbs (CFL, LED)

VQ10

PW

XO

тип type	описание description	технически данни technical data	допълнителна информация 1 optional data 1
VQ10	КОНТАКТ ШУКО SOCKET SCHUKO	2P+E 16A 250V~	XO без декоративен панел without cover plate
VQ11	КОНТАКТ ШУКО+КАПАК SOCKET SCHUKO+COVER	2P+E 16A 250V~	
VQ12	КОНТАКТ ШУКО SOCKET SCHUKO	2P+E 16A 250V~ BV	
⋮		⋮	
⋮		⋮	

ЦВЯТ
colour

<input type="checkbox"/> PW	полярно бяло polar white	<input checked="" type="checkbox"/> PT	бяло + прозрачно white+transparent	<input type="checkbox"/> PP	бяло + бяло white+white
<input type="checkbox"/> TI	титан titanium	<input checked="" type="checkbox"/> TT	титан + прозрачно titanium+transparent	<input type="checkbox"/> TI	титан + титан titanium+titanium
<input type="checkbox"/> AT	антрацит anthracite	<input checked="" type="checkbox"/> AT	антрацит + прозрачно anthracite+transparent	<input type="checkbox"/> AA	антрацит + антрацит anthracite+anthracite
<input type="checkbox"/> BK	черно black	<input checked="" type="checkbox"/> BT	черно + прозрачно black+transparent	<input type="checkbox"/> BB	черно + черно black+black
<input type="checkbox"/> RD	червено red	<input checked="" type="checkbox"/> RT	червено + прозрачно red+transparent	<input type="checkbox"/> RR	червено + червено red+red
<input type="checkbox"/> GR	зелено green	<input checked="" type="checkbox"/> GT	зелено + прозрачно green+transparent	<input type="checkbox"/> GG	зелено + зелено green+green
<input type="checkbox"/> OR	оранжево orange	<input checked="" type="checkbox"/> OT	оранжево + прозрачно orange+transparent	<input type="checkbox"/> OO	оранжево + оранжево orange+orange



шuko - в съответствие с EN 60884-1, CEE7 (лист със стандарти III)

schuko - in accordance with EN 60884-1, CEE7 (standard sheet III)

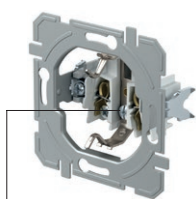

винтови контакти
screw contacts

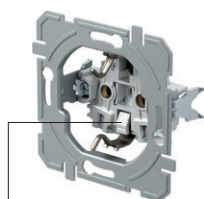

BV контакти чрез вкарване
BV plug-in contacts

S O C K E T S V Q

КОНТАКТ ШУКО 2P+E 16A 250V~ __ XO

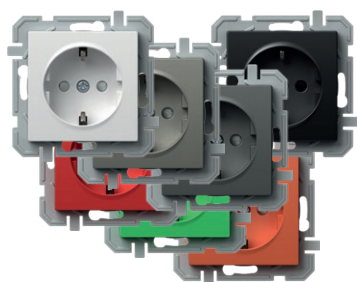

- VQ10PWXO
- VQ10TIXO
- VQ10ATXO
- VQ10BKXO

- VQ10RDXO
- VQ10GRXO
- VQ10ORXO

- винтови контакти 1,5-2,5 mm²
- XO без панел
- 2P+E шуко
- 16A 250V~, тип VQ10
- Вградена защита от допир на контакти



SOCKET SCHUKO 2P+E 16A 250V~ __ XO

- screw contacts 1.5-2.5mm²
- XO without surround
- 2P+E schuko
- 16A 250V~, type VQ10
- shuttered live contacts

КОНТАКТ ШУКО+КАПАК 2P+E 16A 250V~ __ XO

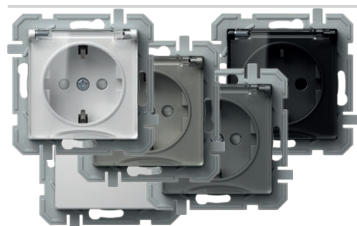

- VQ11PTXO
- VQ11TTXO
- VQ11ATXO
- VQ11BTXO

- VQ11PPXO

- винтови контакти 1,5-2,5 mm²
- XO без панел
- 2P+E шуко+капак
- 16A 250V~, тип VQ11
- Вградена защита от допир на контакти



SOCKET SCHUKO+COVER 2P+E 16A 250V~ __ XO

- screw contacts 1.5-2.5mm²
- XO without surround
- 2P+E schuko+cover
- 16A 250V~, type VQ11
- shuttered live contacts

КОНТАКТ ШУКО 2P+E 16A 250V~ BV __ XO

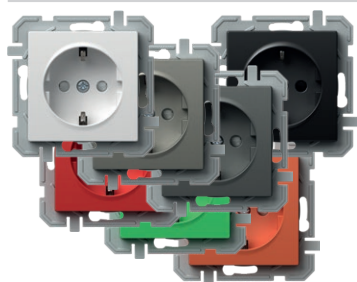

- VQ12PWXO
- VQ12TIXO
- VQ12ATXO
- VQ12BKXO

- VQ12RDXO
- VQ12GRXO
- VQ12ORXO

- BV контакти чрез вкарване 1,5-2,5 mm²
- XO без панел
- 2P+E шуко
- 16A 250V~, тип VQ12
- Вградена защита от допир на контакти



SOCKET SCHUKO 2P+E 16A 250V~ BV __ XO

- BV plug-in contacts 1.5-2.5mm²
- XO without surround
- 2P+E schuko
- 16A 250V~, type VQ12
- shuttered live contacts

КОНТАКТ ШУКО+КАПАК 2P+E 16A 250V~ BV __ XO



- VQ13PTXO
- VQ13TTXO
- VQ13ATXO
- VQ13BTXO

- VQ13PPXO

- BV контакти чрез вкарване 1,5-2,5 mm²
- XO без панел
- 2P+E шуко+капак
- 16A 250V~, тип VQ13
- Вградена защита от допир на контакти



SOCKET SCHUKO+COVER 2P+E 16A 250V~ BV __ XO

- BV plug-in contacts 1.5-2.5mm²
- XO without surround
- 2P+E schuko+cover
- 16A 250V~, type VQ13
- shuttered live contacts

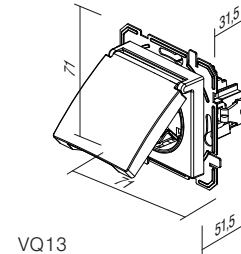
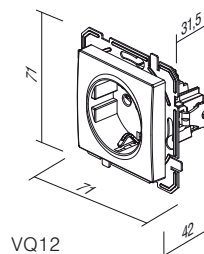
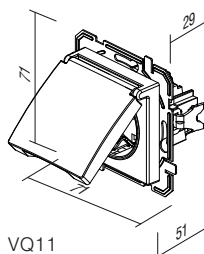
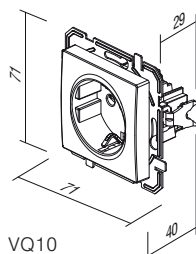

КОНТАКТ ФРЕНСКИ 2P+E 16A 250V~ __ XO

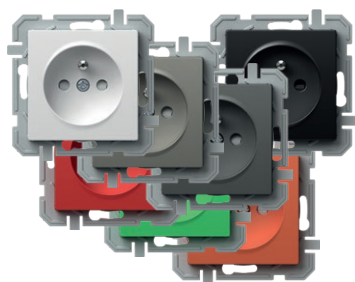

- VQ40PWXO
- VQ40TIXO
- VQ40ATXO
- VQ40BKXO
- VQ40RDXO
- VQ40GRXO
- VQ40ORXO

- винтови контакти 1,5 - 2,5 mm²
- XO без панел
- 2P+E френски контакт
- 16A 250V~, тип VQ40
- Вградена защита от допир на контакти



SOCKET FRENCH 2P+E 16A 250V~ __ XO

- screw contacts 1.5-2.5mm²
- XO without surround
- 2P+E French
- 16A 250V~, type VQ40
- shuttered live contacts

КОНТАКТ ФРЕНСКИ+КАПАК 2P+E 16A 250V~ __ XO



- ▣ VQ41PTXO
- ▣ VQ41TTXO
- ▣ VQ41ATXO
- ▣ VQ41BTXO
- VQ41PPXO

- винтови контакти 1,5 - 2,5 mm²
- XO без панел
- 2P+E френски контакт+капак
- 16A 250V~, тип VQ41
- Вградена защита от допир на контакти



SOCKET FRENCH+COVER 2P+E 16A 250V~ __ XO

- screw contacts 1.5-2.5mm²
- XO without surround
- 2P+E French+cover
- 16A 250V~, type VQ41
- shuttered live contacts

КОНТАКТ ШУКО ДВОЕН 2P+E 16A 250V~



- VQ16PWF
- VQ16TIF
- VQ16ATF
- VQ16BKF

- 2P+E шуко двоен
- 16A 250V~, тип VQ16
- в съответствие с IEC 60884-1, CEE7
- винтови контакти 1,5-2,5 mm²
- Вградена защита от допир на контакти



SOCKET SCHUKO DOUBLE 2P+E 16A 250V~

- 2P+E schuko double
- 16A 250V~, type VQ16
- in accordance with IEC 60884-1, CEE7
- screw contacts 1.5-2.5 mm²
- shuttered live contacts

КОНТАКТ ШУКО ДВОЕН 2P+E 16A 250V~



- VQ16PW
- VQ16TI
- VQ16AT
- VQ16BK

- 2P+E шуко двоен
- 16A 250V~, тип VQ16
- в съответствие с IEC 60884-1, CEE7
- винтови контакти 1,5-2,5 mm²
- Вградена защита от допир на контакти



SOCKET SCHUKO DOUBLE 2P+E 16A 250V~

- 2P+E schuko double
- 16A 250V~, type VQ16
- in accordance with IEC 60884-1, CEE7
- screw contacts 1.5-2.5 mm²
- shuttered live contacts

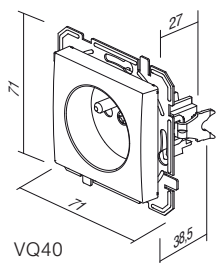

VQ40

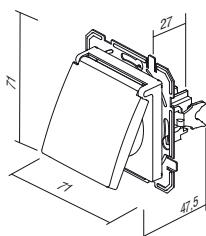

VQ41

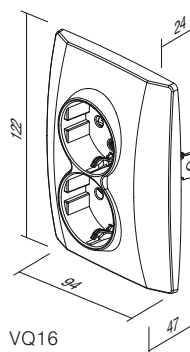

VQ16

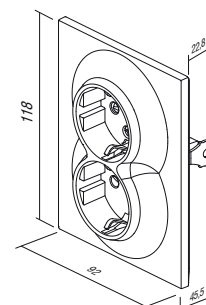

VQ16F

S O C K E T S V Q

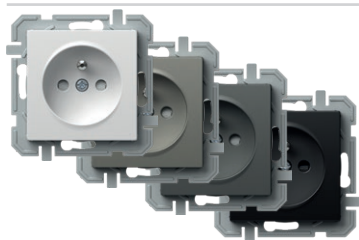

- VQ42PWXO
- VQ42TIXO
- VQ42ATXO
- VQ42BKXO

КОНТАКТ ФРЕНСКИ 2P+E 16A 250V~ BV __ XO

- BV контакти чрез вкарване 1,5 - 2,5 mm²
- XO без панел
- 2P+E френски контакт
- 16A 250V~, тип VQ42
- Вградена защита от допир на контакти



SOCKET FRENCH 2P+E 16A 250V~ BV __ XO

- BV plug-in contacts 1.5-2.5mm²
- XO without surround
- 2P+E French
- 16A 250V~, type VQ42
- shuttered live contacts



- VQ43PTXO
- VQ43TTXO
- VQ43ATXO
- VQ43BTXO

КОНТАКТ ФРЕНСКИ+КАПАК 2P+E 16 A 250 V~ BV __ XO

- BV контакти чрез вкарване 1,5 - 2,5 mm²
- XO без рамка
- 2P+E френски контакт+капак
- 16 A 250 V~, тип VQ43
- Вградена защита от допир на контакти



SOCKET FRENCH+COVER 2P+E 16A 250V~ BV __ XO

- BV plug-in contacts 1.5-2.5mm²
- XO without surround
- 2P+E French+cover
- 16A 250V~, type VQ43
- shuttered live contacts



- VQ46PWXO
- VQ46TIXO
- VQ46ATXO
- VQ46BKXO

КОНТАКТ ФРЕНСКИ ДВОЕН 2P+E 16A 250V~

- 2P+E френски двоен, 16A 250V~, тип VQ46
- в съответствие с IEC 60884-1, CEE7; NF C 61-314, CSN 33 2318; PN-E 93201
- винтови контакти 1,5 - 2,5 mm²
- Вградена защита от допир на контакти



SOCKET FRENCH DOUBLE 2P+E 16A 250V~

- 2P+E French double
- 16A 250V~, type VQ46
- in accordance with IEC 60884-1, CEE7; NF C 61-314, CSN 33 2318; PN-E 93201
- screw contacts 1,5-2,5 mm²
- shuttered live contacts



- VQ46PWXO
- VQ46TIXO
- VQ46ATXO
- VQ46BKXO

КОНТАКТ ФРЕНСКИ ДВОЕН 2P+E 16A 250V~

- 2P+E френски двоен, 16A 250V~, тип VQ46
- в съответствие с IEC 60884-1, CEE7; NF C 61-314, CSN 33 2318; PN-E 93201
- винтови контакти 1,5 - 2,5 mm²
- Вградена защита от допир на контакти



SOCKET FRENCH DOUBLE 2P+E 16A 250V~

- 2P+E French double
- 16A 250V~, type VQ46
- in accordance with IEC 60884-1, CEE7; NF C 61-314, CSN 33 2318; PN-E 93201
- screw contacts 1,5-2,5 mm²
- shuttered live contacts

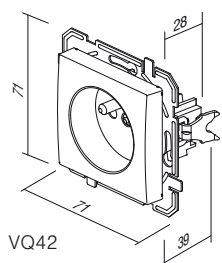

VQ42

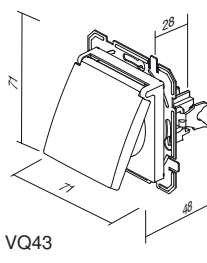

VQ43

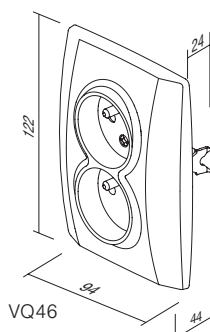

VQ46

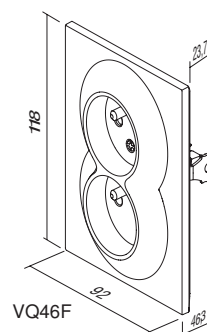

VQ46F

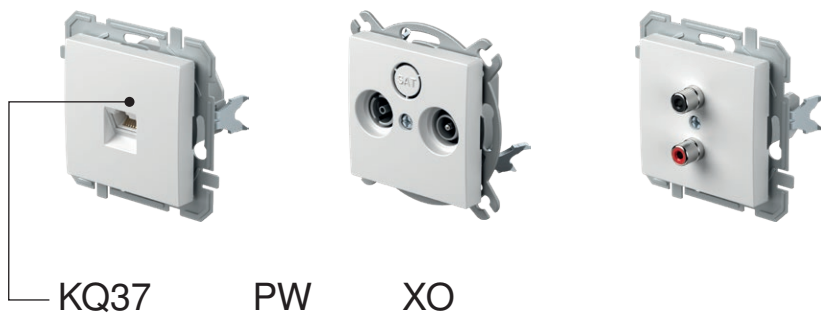

тип type	описание description	технически данни technical data	цвет colour	допълнителна информация 1 optional data 1
KQ11	КОНТАКТ ЗА ТВ-РАДИО КРАЕН SOCKET TV-R END-LINE	1dB	□ PW полярно бяло polar white	XO без декоративен панел without cover plate
KQ12	КОНТАКТ ЗА ТВ-РАДИО ПРЕХОДЕН SOCKET TV-R THROUGHPASS	10dB	■ TI титан titanium	
KQ16	КОНТАКТ ЗА САТЕЛИТНА ТВ-РАДИО КРАЕН SOCKET SAT-TV-R END-LINE	3dB	■ AT антрацит anthracite	
...	■ BK черно black	

КОНТАКТ ЗА ТВ БАЗОВ 0 dB



- KQ10PWXO
- KQ10TIXO
- KQ10ATXO
- KQ10BKXO

- контакт за ТВ базов
- затихване 0dB
- заден конектор – стандарт F
SOCKET TV BASIC 0dB
- TV basic
- reduction 0dB
- back connector – F standard



КОНТАКТ ЗА ТВ-РАДИО КРАЕН 1 dB

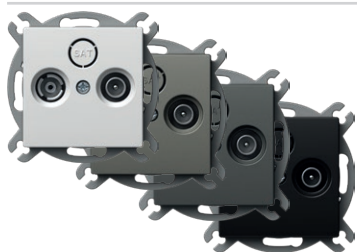

- KQ11PWXO
- KQ11TIXO
- KQ11ATXO
- KQ11BKXO

- за ТВ-радио краен
- честотен обхват 5÷862 MHz
- затихване: Радио – 1,5 dB, ТВ – 1 dB
- в съответствие с EN 50083-1
- винтов контакт
SOCKET TV-R END-LINE 1dB
- TV-R end-line
- frequency range 5÷862 MHz
- reduction: R-1.5dB, TV-1dB
- in accordance with EN 50083-1
- screw contact



КОНТАКТ ЗА ТВ-РАДИО ПРЕХОДЕН 10 dB

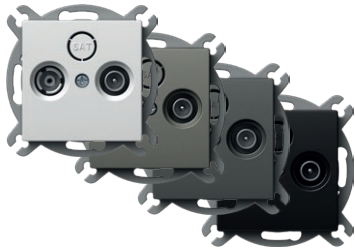

- KQ12PWXO
- KQ12TIXO
- KQ12ATXO
- KQ12BKXO

- за ТВ-радио преходен
- честотен обхват 5÷862 MHz
- затихване: Радио – 10 dB, ТВ – 10 dB, преход – 2 dB
- в съответствие с EN 50083-1
- винтови контакти

SOCKET TV-R TROUGHPASS 10dB

- TV-R troughpass
- frequency range 5÷862 MHz
- reduction: R-10dB, TV-10dB, trough-2dB
- in accordance with EN 50083-1
- screw contacts



КОНТАКТ ЗА САТЕЛИТНА ТВ-РАДИО КРАЕН 3 dB

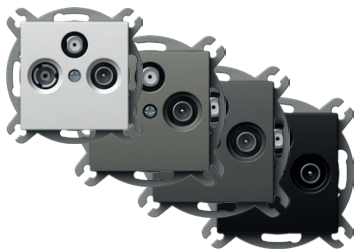

- KQ16PWXO
- KQ16TIXO
- KQ16ATXO
- KQ16BKXO

- за сателитна ТВ-радио краен
- честотен обхват 5÷2400 MHz
- затихване: Радио – 1 dB, ТВ – 1,5 dB, сателитна ТВ – 3 dB
- в съответствие с EN 50083-1
- винтови контакти

SOCKET SAT-TV-R END-LINE 3dB

- SAT-TV-R end-line
- frequency range 5÷2400 MHz
- reduction: R-1dB, TV-1.5dB, SAT-3dB
- in accordance with EN 50083-1
- screw contacts



КОНТАКТ ЗА АУДИОСИГНАЛИ 2xRCA



- KQ22PWXO
- KQ22TIXO
- KQ22ATXO
- KQ22BKXO

- за аудиосигнали 2xRCA
- свързване на кабела чрез запояване

SOCKET AUDIO 2xRCA

- audio 2xRCA
- soldering connection of cable



КОНТАКТ ЗА ВИСОКОГОВОРТЕЛИ



- KQ23PWXO
- KQ23TIXO
- KQ23ATXO
- KQ23BKXO

- за аудиосигнали 2x Ø4 mm
- за проводник за високоговорители, с щепсел тип банан Ø4 mm или плоски конектори
- свързване на кабела от задната страна чрез запояване

SOCKET AUDIO LOUDSPEAKERS

- audio 2x Ø4mm
- to accommodate speaker wire, banana plug Ø4mm or spades
- soldering connection of cable at the back side



КОНЕКТОР ЗА ТЕЛЕФОН KS RJ11 6/4



- KQ36PWXO
- KQ36TIXO
- KQ36ATXO
- KQ36BKXO

- KS модулен стандарт за закрепване
- RJ11 6/4
- в съответствие с IEC 60603-7

SOCKET TEL KS RJ11 6/4

- KS keystone fixing standard
- RJ11 6/4
- in accordance with IEC 60603-7



КОНЕКТОР CAT5e KS RJ45 8/8



- KQ37PWXO
- KQ37TIXO
- KQ37ATXO
- KQ37BKXO

- KS модулен стандарт за закрепване
- CAT5e, RJ45 8/8
- в съответствие с IEC 60603-7

SOCKET CAT5e KS RJ45 8/8

- KS keystone fixing standard
- CAT5e, RJ45 8/8
- in accordance with IEC 60603-7



КОНЕКТОР ЗА ТЕЛЕФОН KS ДВОЕН 2x RJ11 6/4



- KQ38PWXO
- KQ38TIXO
- KQ38ATXO
- KQ38BKXO

- KS модулен стандарт за закрепване
- 2x RJ11, 6/4
- в съответствие с IEC 60603-7

SOCKET TEL KS DOUBLE 2x RJ11 6/4

- KS keystone fixing standard
- 2x RJ11, 6/4
- in accordance with IEC 60603-7



КОНЕКТОР CAT5e KS ДВОЕН 2x RJ45 8/8



- KQ39PWXO
- KQ39TIXO
- KQ39ATXO
- KQ39BKXO

- KS модул стандарт за закрепване
- 2x CAT5e, RJ45 8/8
- в съответствие с IEC 60603-7

SOCKET CAT5e KS DOUBLE 2x RJ45 8/8

- KS keystone fixing standard
- 2x CAT5e, RJ45 8/8
- in accordance with IEC 60603-7



КОНЕКТОР ЗА ТЕЛЕФОН LT RJ11 6/4



- KQ35PWXO
- KQ35TIXO
- KQ35ATXO
- KQ35BKXO

- телефонен LT винтов
- винтови контакти
- RJ11 6/4
- в съответствие с IEC 60603-7

SOCKET TEL LT RJ11 6/4

- TEL LT screw
- screw contacts
- RJ11 6/4
- in accordance with IEC 60603-7



КОНЕКТОР CAT6s KS RJ45 8/8 SLIM

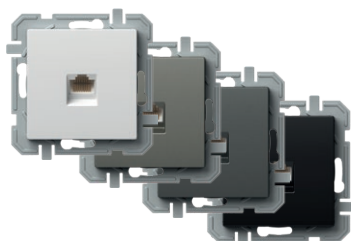

- KQ40PWXO
- KQ40TIXO
- KQ40ATXO
- KQ40BKXO

- KS модул стандарт за закрепване
- CAT6s, RJ45 8/8
- в съответствие с IEC 60603-7

SOCKET CAT6s KS RJ45 8/8 SLIM

- KS keystone fixing standard
- CAT6s, RJ45 8/8
- in accordance with IEC 60603-7



КОНЕКТОР CAT6s KS ДВОЕН 2x RJ45 8/8 SLIM

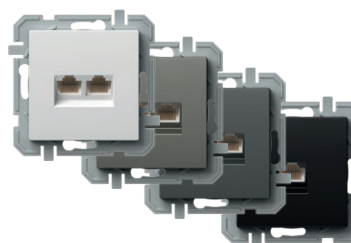

- KQ41PWXO
- KQ41TIXO
- KQ41ATXO
- KQ41BKXO

- KS модул стандарт за закрепване
- 2x CAT6s, RJ45 8/8
- в съответствие с IEC 60603-7

SOCKET CAT6s KS DOUBLE 2x RJ45 8/8 SLIM

- KS keystone fixing standard
- 2x CAT6s, RJ45 8/8
- in accordance with IEC 60603-7

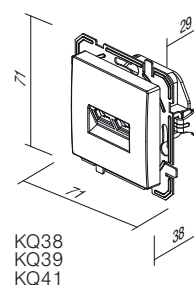
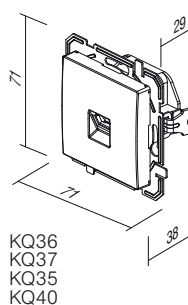
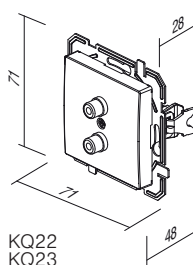
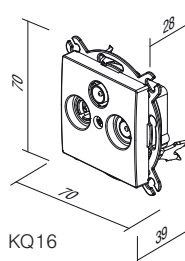
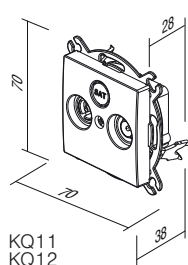
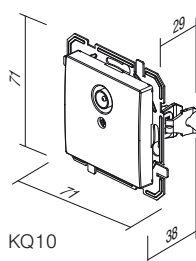



EQ15

PW

XO

тип type	описание description	технически данни technical data	цвет colour	допълнителна информация 1 optional data 1
EQ15	ДИМЕР, ВЪРТЯЩ ТИП, ДВУПОСОЧЕН DIMMER ROTATIVE 2WAY	RL 400W	<input type="checkbox"/> PW полярно бяло polar white	XO без декоративен панел without cover plate
EQ16	ДИМЕР, ВЪРТЯЩ ТИП, ДВУПОСОЧЕН DIMMER ROTATIVE 2WAY	RLC 400W	<input type="checkbox"/> TI титан titanium	
EQ19	ДИМЕР, ВЪРТЯЩ ТИП, ДВУПОСОЧЕН DIMMER ROTATIVE 2WAY	LED 100W	<input type="checkbox"/> AT антрацит anthracite	
⋮			<input type="checkbox"/> BK черно black	

ДИМЕР, ВЪРТЯЩ ТИП, ДВУПОСОЧЕН,
АКТИВЕН/ИНДУКТИВЕН ТОВАР 400 W



- EQ15PWXO
- EQ15TIXO
- EQ15ATXO
- EQ15BKXO



- управление чрез завъртане, с двупосочен ключ
- активен/индуктивен товар, 40 W - 400 W
- възможна е комбинация с двупосочен ключ
- не се допуска комбинация с допълнителни димери
- в съответствие с EN 60669-1 and EN 60669-2-1
- контакти чрез вкарване на проводниците 1,5 mm²
- захранващо напрежение 230 V~ 50 Hz
- предпазител за смяна е включен в доставката



DIMMER ROTATIVE 2WAY RL 400W

- rotation control with 2-way switch
- load RL, 40W - 400W
- 2-way switch combination is possible
- more dimmers combination is not allowed
- in accordance with EN 60669-1 and EN 60669-2-1
- plug-in contacts 1.5mm²
- supply 230V~ 50Hz
- replaceable fuse included

ДИМЕР, ВЪРТЯЩ ТИП, ДВУПОСОЧЕН,
АКТИВЕН/ИНДУКТИВЕН/КАПАЦИТИВЕН ТОВАР 400 W

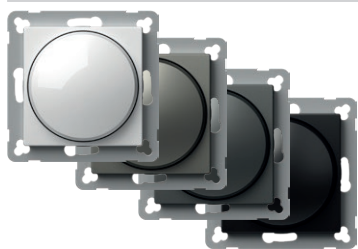

- EQ16PWXO
- EQ16TIXO
- EQ16ATXO
- EQ16BKXO



- управление чрез завъртане, с двупосочен ключ
- активен/индуктивен/капацитивен товар, 20 W - 400 W
- възможна е комбинация с двупосочен ключ
- не се допуска комбинация с допълнителни димери
- в съответствие с EN 60669-1 and EN 60669-2-1
- контакти чрез вкарване на проводниците 1,5 mm²
- захранващо напрежение 230 V~ 50 Hz
- електронен предпазител



DIMMER ROTATIVE 2WAY RLC 400W

- rotation control with 2-way switch
- load RLC, 20W - 400W
- 2-way switch combination is possible
- more dimmers combination is not allowed
- in accordance with EN 60669-1 and EN 60669-2-1
- plug-in contacts 1.5mm²
- supply 230V~ 50Hz
- electronic fuse

ДИМЕР, ВЪРТЯЩ ТИП, ДВУПОСОЧЕН, ЗА
СВЕТОДИОДНО ОСВЕТЛЕНИЕ 100 W

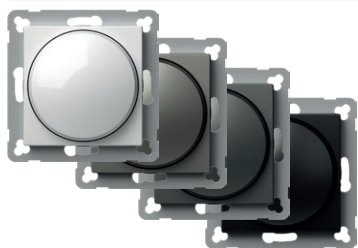

- EQ19PWXO
- EQ19TIXO
- EQ19ATXO
- EQ19BKXO



- управление чрез завъртане, с двупосочен ключ
- това: светодиодно осветление, 0-100 W (макс. 10 светодиода)
GLS, 10-250 W
- възможна е комбинация с двупосочен ключ
- не се допуска комбинация с допълнителни димери
- в съответствие с EN 60669-1 and EN 60669-2-1
- контакти чрез вкарване на проводниците 1,5 mm²
- захранващо напрежение 230 V~ 50 Hz
- предпазител за смяна е включен в доставката



DIMMER ROTATIVE 2WAY LED 100W

- rotation control with 2-way switch
- load: LED, 0-100W (max. 10 LEDs)
GLS, 10-250W
- 2-way switch combination is possible
- more dimmers combination is not allowed
- in accordance with EN 60669-1 and EN 60669-2-1
- plug-in contacts 1.5mm²
- supply 230V~ 50Hz
- replaceable fuse included

EQ15, EQ16, EQ19

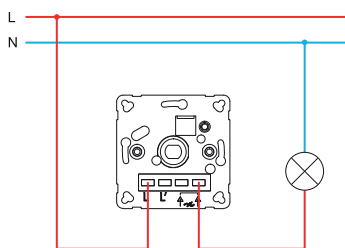

EQ15, EQ16, EQ19

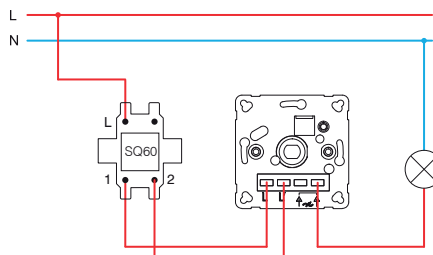

EQ15, EQ16, EQ19

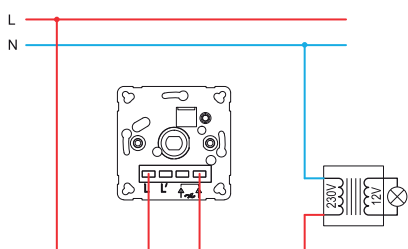

EQ15, EQ16, EQ19

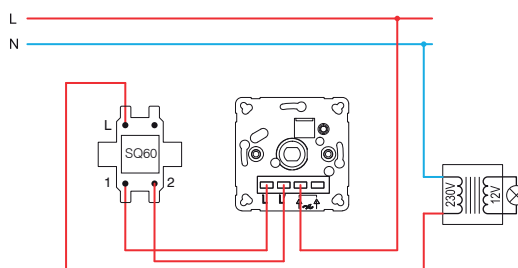

EQ16, EQ19

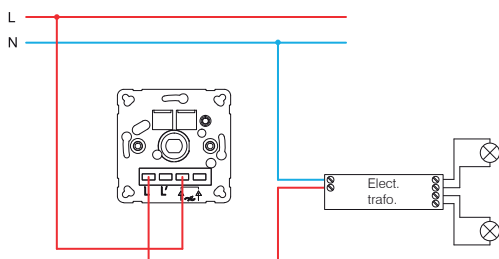

EQ16, EQ19

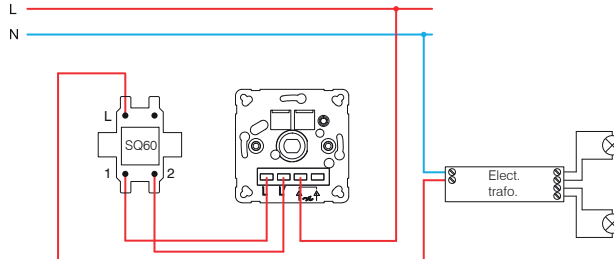
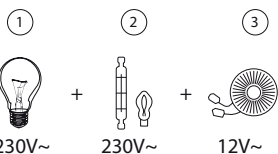
**EQ15 (40÷400W)**

- 1 - лампа с нажежаема жичка
incandescent lamp
- 2 - халогенна лампа
halogen lamp

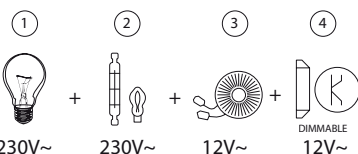
EQ16 (20÷400W)

- 3 - класически трансформатор
classical transformer
- 4 - димиращ електронен трансформатор
dimnable electronic transformer

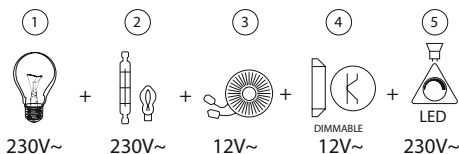
EQ19 (GLS 10÷250W ; LED 0÷100W)

- 5 - димируема светодиодна лампа
dimnable LED lamp

УПРАВЛЯВАЩ модул MZC за EM18

EM17

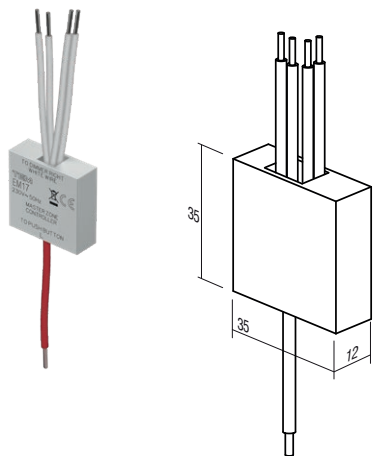

- свържете MZC, съгласно схемата за свързване.
- възможно свързване с няколко бутона.
- монтаж само на едно устройство в една конзола
- само за вътрешно ползване
- захранване: 230 V~ 50Hz
- максимално съпротивление на жиците: 50 kΩ
- максимален ток през част MZC: 10 mA
- брой димери на MZC: 1-4
- максимален брой MZC в мрежата: ограничено до предпазител в движението на тока- температура при функциониране: -5 °C до 45 °C
- температура на складиране: -30 °C до 80 °C
- максимална влажност: 90% (без кондензиране)
- размери на корпуса: 36 x 36 x 12 mm.

MZC CONTROL Module for EM18

- Connect the MZC according to the wiring diagram.
- Possible wiring with several push buttons.
- Only one device installation per mounting box.
- For indoor use only.
- Power supply: 230V~ 50Hz
- Max. cable resistance: 50kΩ
- Max. current per MZC unit: 10mA
- Number of dimmers on MZC: 1-4
- Max. number of MZC in the wiring: limited to the fuse in the circuit
- Operating temperature: -5°C to 45°C
- Storage temperature: -30°C to 80°C
- Max. humidity: 90% (no condensation)
- Casing dimensions: 36x36x12 mm

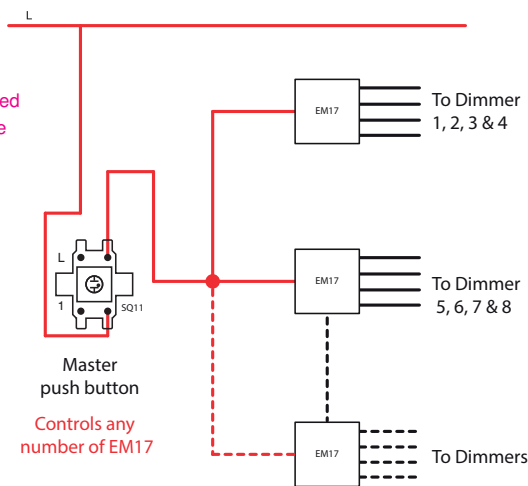
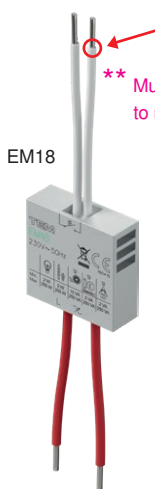
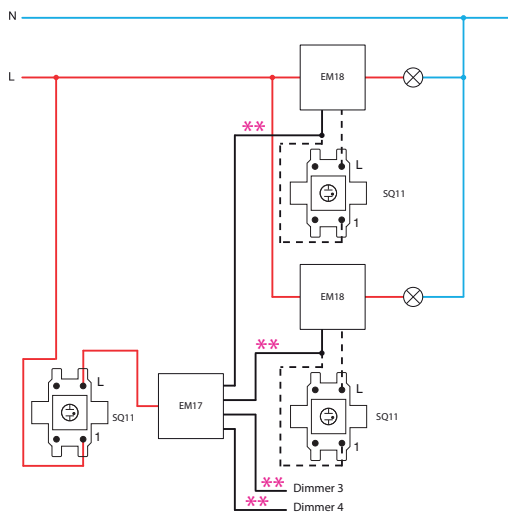

ДИМЕРНО УСТРОЙСТВО ЗА СВЕТОДИОДИ 250W

EM18

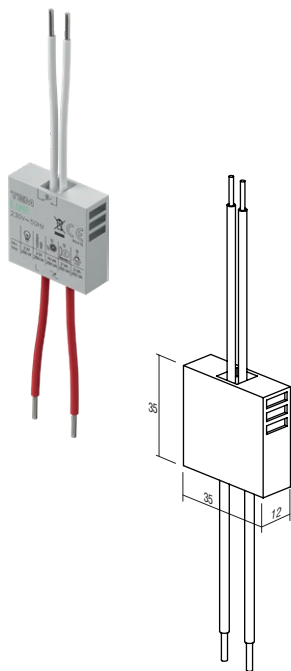

- вградена кутия, управлява се външно чрез бутон
- за индуктивен и капацитивен товар
- захранващо напрежение 230 V~ 50 Hz
- възможни са няколко комбинации с бутони
- функция за запамятаване на последната настройка, освен при прекъсване на захранването
- функция за плавен старт/стоп
- контрол на минималния интензитет
- само един димер за стенна кутия
- само за употреба на закрито
- в съответствие с EN 60669-1 и EN 60669-2-1

DIMMER INBOX LED 250W

- inbox, controlled by external push button
- for leading or trailing edge
- supply voltage 230V~ 50Hz
- several push-buttons combinations is possible
- memory function of the last setting, except in the case of a power failure
- soft start / stop function
- minimum intensity control
- only one dimmer per wall box
- only for indoor usage
- in accordance with EN 60669-1 and EN 60669-2-1

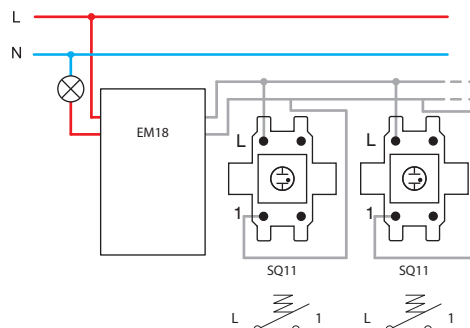

ДИМЕРНО УСТРОЙСТВО ЗА СВЕТОДИОДИ, ПОСТОЯНЕН ТОК 96 W

EM19

- вградена кутия, управлява се външно чрез бутон
- за употреба със светодиодни драйвери с постоянен напрежение и някои светодиодни драйвери с постоянен ток, 9 – 48 V DC, макс. 96 W (подходящо и за светодиодни ленти)
- не е подходящо за употреба при индуктивен товар
- възможни са комбинации от няколко бутона и няколко димера
- функция за запаметяване на последната настройка, освен при прекъсване на захранването
- функция за плавен старт/стоп
- само един димер за стена кутия
- само за употреба на закрито

DIMMER INBOX DC LED 96W

- inbox, controlled by external push button
- for use with constant voltage LED drivers and some constant current LED drivers, 9-48V DC, max 96W (also for LED strips)
- not for use with inductive loads
- several push-buttons combinations and several dimmers is possible
- memory function of the last setting, except in the case of a power failure
- soft start / stop function
- only one dimmer per wall box
- only for indoor usage

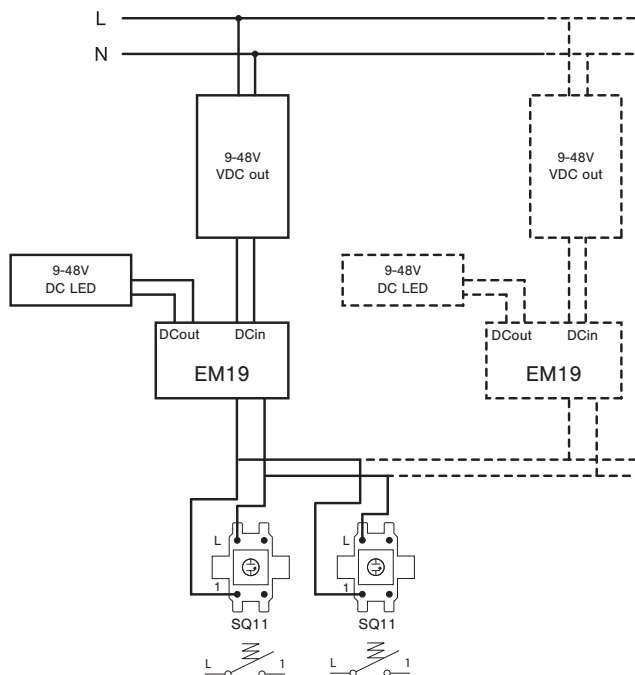
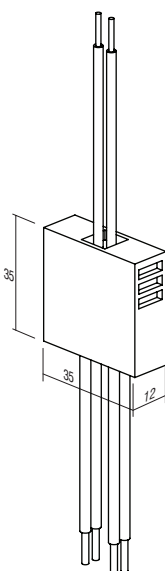
**ВНИМАНИЕ!**

Ако няколко димера са свързани в една конзола, намалете допустимата обща максимална мощност с 10 % за всеки димер.

ATTENTION!

If more dimmers are connected in one box reduce maximum common power for 10% for each dimmer.

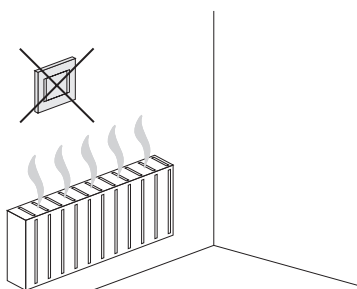

EM18 (2÷250VA)

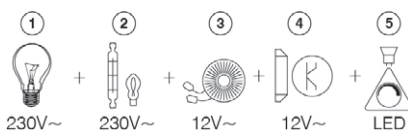

- 1 – лампа с нажежаема жичка / incandescent lamp
- 2 – халогенна лампа / halogen lamp
- 3 – класически трансформатор / classical transformer
- 4 – Димиращ електронен трансформатор / dimmable electronic transformer
- 5 – димируема светодиодна лампа / dimmable LED lamp

ИЧ КЛЮЧ 5А 230V~



- EQ32PWXO
- EQ32TIXO
- EQ32ATXO
- EQ32BKXO



- инфрачервен ключ IR
- захранващо напрежение: 230V~ ±10% 50 Hz
- реле: 5A / 250V~ изход за ограничен ток с висока устойчивост за нулевата стойност
- клас на защита: IP40
- сечение на проводниците при контакта: 0,75 - 2,5 mm²
- ъгъл на откриване: до 110° при 20°C
- разстояние на откриване: припл. 8 m при 20°C
- регулируема продължителност: от припл. 5 сек до 12 min
- регулиране на яркостта на осветлението: от припл. 5 до 200 лукса
- работна температура: от 0°C до +40°C
- не е подходящо за инсталиране в конзоли с дълбочина 45 mm
- само за употреба на закрито

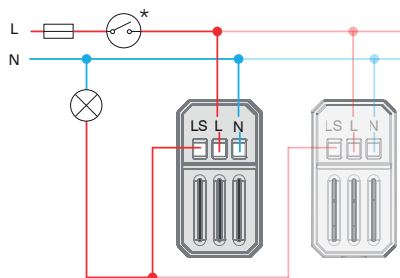

IR SWITCH 5A 230V~

- IR infrared switch
- supply voltage: 230V~ ±10 % 50Hz
- relay: 5A / 250V~ output for limited current with high resistance for zero crossing
- protection rating: IP40
- cross-section of wires at the contact terminal: 0.75 - 2.5 mm²
- detection angle: up to 110° at 20°C
- detection area: approx. 8 m at 20°C
- adjustability of duration: from approx. 5 s to 12 min
- adjustability of brightness: from approx. 5 to 200 LUX
- operating temperature: from 0°C to +40°C
- not suitable for installation in 45 mm deep boxes
- only for indoor usage

ОТОПЛЕНИЕ С ТЕРМОСТАТ 10А 230V~

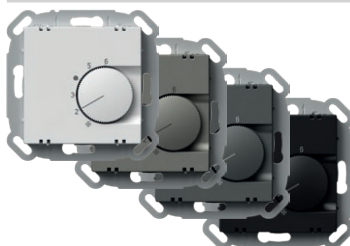

- EQ35PWXO
- EQ35TIXO
- EQ35ATXO
- EQ35BKXO

- работен режим: отопление
- захранване: 230 V~, 50 Hz
- изход: 4 А (макс. 10 А), 230 V~, 50 Hz
- комутационен контактор: NC (макс. 10 устройства)
- обхват на регулиране: +5°C до +30°C
- хистерезис: 0,5 К
- защита: IP30
- тип датчик: биметален
- тип електрическа връзка: пружинно натоварени контакти
- типове проводници: 0,75 – 1,5 mm² (гъвкаво-вплетена основа) или 1,0 – 2,5 mm² (солидна основа)

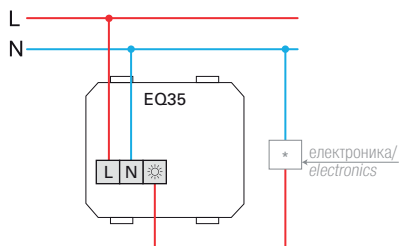

THERMOSTAT HEATING 10A 230V~

- operation mode: heating
- power supply: 230 V~, 50 Hz
- output: 4 A (max. 10 A), 230 V~, 50 Hz
- switching contact: NC (max. 10 actuators)
- regulation range: +5 °C to +30 °C
- hysteresis: 0,5 K
- protection: IP30
- sensor type: bimetal
- type of electrical connection: spring-loaded contacts
- type of conductors: 0,75 – 1,5mm² (flexible-stranded core) or 1,0 – 2,5 mm² (solid core)

ОТОПЛЕНИЕ/ОХЛАЖДАНЕ С ТЕРМОСТАТ 5А 230V~

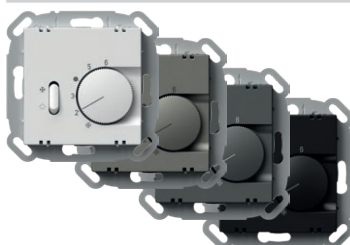

- EQ36PWXO
- EQ36TIXO
- EQ36ATXO
- EQ36BKXO

- работен режим: отопление/охлаждане
- захранване: 230 V~, 50 Hz
- изход: 2 А (макс. 5 А), 230 V~, 50 Hz
- комутационен контактор: превключващ ключ (превключвател, макс. 5 устройства)
- обхват на регулиране: +5°C до +30°C
- хистерезис: 0,5 К
- защита: IP30
- тип датчик: биметален
- тип електрическа връзка: пружинно натоварени контакти
- типове проводници: 0,75 – 1,5 mm² (гъвкаво-вплетена основа) или 1,0 – 2,5 mm² (солидна основа)

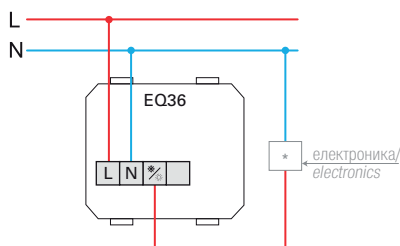

THERMOSTAT HEATING / COOLING 5A 230V~

- operation mode: heating / cooling
- power supply: 230 V~, 50 Hz
- output: 2 A (max. 5 A), 230 V~, 50 Hz
- switching contact: changeover switch (toggler, max. 5 actuators)
- regulation range: +5 °C to +30 °C
- hysteresis: 0,5 K
- protection: IP30
- sensor type: bimetal
- type of electrical connection: spring-loaded contacts
- type of conductors: 0,75 – 1,5mm² (flexible-stranded core) or 1,0 – 2,5 mm² (solid core)

ПОДОВО ОТОПЛЕНИЕ С ТЕРМОСТАТ 16A 230V~

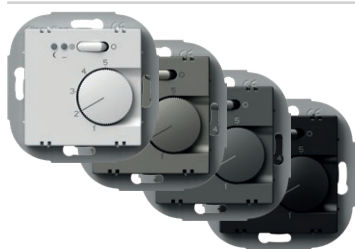

- EQ37PWXO
- EQ37TIXO
- EQ37ATXO
- EQ37BKXO

- работен режим: подово отопление
- захранване: 230 V~, 50 Hz
- изход: 2 A (макс. 16 A), 230 V~, 50 Hz
- обхват на регулиране: +10 °C до +50 °C
- хистерезис: 1 K
- защита: IP30
- тип датчик: NTC в съответствие с DIN EN 60730-2-1
- индикатори: Червен светодиод за отопление и зелен светодиод за режим на намаляване през нощта
- тип електрическа връзка: Винтови контакти
- типове проводници: 0,5 - 2,5 mm²

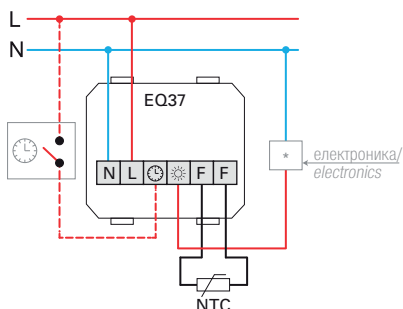

THERMOSTAT FLOOR HEATING 16A 230V~

- operation mode: floor heating
- power supply: 230 V~, 50 Hz
- output: 2 A (max. 16 A), 230 V~, 50 Hz
- regulation range: +10 °C to +50 °C
- hysteresis: 1 K
- protection: IP30
- sensor type: NTC in compliance with DIN EN 60730-2-1
- indicators: Red LED for heating and green LED for night decrease mode
- type of electrical connection: Screw contacts
- type of conductors: 0,5 - 2,5mm²



ПОДМАЗИЛКОВО РАДИО + ТОНКОЛОНА DAB BLUETOOTH



BLUETOOTH



- EQ01PWXO

- захранване: 230 V~ / 50 Hz
- енергопотребление при обичайно функциониране: макс. 6 W
- енергопотребление в режим на готовност: < 0.5 W
- защита от категория: IP20
- честота на приемане: DAB/DAB+ 174,928-239,200 MHz FM: 87,5-108 MHz
- bluetooth: версия V4.1, 2,402-2,480 GHz; клас 2, макс. +4 dBm
- изход за музика: 2 x 2W RMS
- разширен вход: за външен ключ (включване на радиото/готовност)
- екологични условия: относителна влажност: функциониране: 10-75% без кондензация
- съхранение на склад: 5-90%
- температура: функциониране: 5 °C-35 °C
- съхранение на склад: -20 °C-60 °C



FLUSH MOUNTED RADIO + SPEAKER DAB BLUETOOTH

- power supply: 230 V~ / 50 Hz
- power consumption during normal operation: max. 6 W
- power consumption when on standby: < 0.5 W
- protection class: IP20
- reception frequencies: DAB/DAB+ 174.928 - 239.200 MHz FM: 87.5 - 108 MHz
- bluetooth: Version V4.1, 2.402-2.480 GHz Class 2, max. +4 dBm
- music output: 2 x 2W RMS
- extension input: For external switch (Switches radio on/ standby)
- ambient conditions
- relative humidity: Operation: 10 % - 75 % non-condensing
- storage: 5 % - 90 %
- temperature: Operation: 5 °C - 35 °C
- storage: -20 °C - 60 °C



ПОДМАЗИЛКОВА ТОНКОЛОНА



- EQ02PWXO

- защита от категория: IP20
- музикална мощност: 2W RMS
- екологични условия: относителна влажност: функциониране: 10-75% без кондензация
- съхранение на склад: 5-90%
- температура: функциониране: 5-35 °C
- съхранение на склад: -20 °C-60 °C



FLUSH MOUNTED SPEAKER

- protection class: IP20
- music power: 2W RMS
- ambient conditions
- relative humidity: Operation: 10 % - 75 % non-condensing
- storage: 5 % - 90 %
- temperature: Operation: 5 °C - 35 °C
- storage: -20 °C - 60 °C

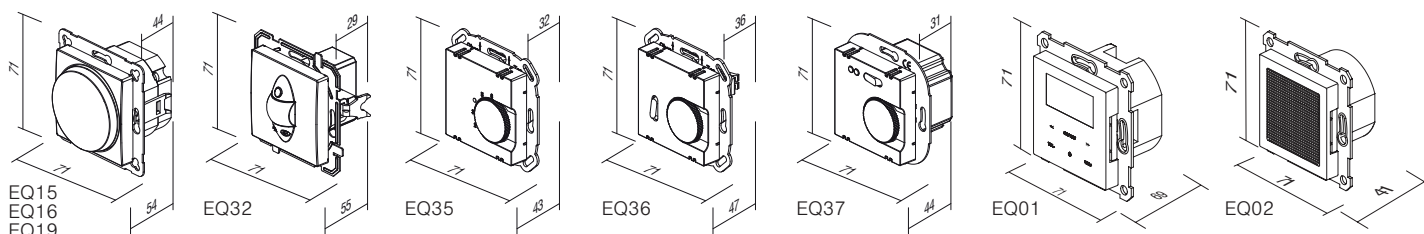
EQ15
EQ16
EQ19

EQ32

EQ35

EQ36

EQ37

EQ01

EQ02

ЗАРЯДНО УСТРОЙСТВО USB PD 20W



- EQ69PWXO
- EQ69TIXO
- EQ69ATXO
- EQ69BKXO

- USB драйвър с осигуряване на мощност до 20W.
- за зареждане на електронни устройства чрез стандартен USB порт (съвместимо и с устройствата Apple).
- захранване: 100-230 V~ 50/60 Hz
- потребление в режим на функциониране 420 mA при 100 V~/220 mA при 230 V~
- потребление в изключен режим: <100 mW при 230 V~
- изходна мощност: Макс 20W.
- Изход/ порт:
- USB тип C 5.0 VDC 3.0A; 9.0 VDC 2.2 A 12.0 VDC 1.67 A (PD 20W)
- USB тип A 5.0 VDC 3.0A; 9.0 VDC 2.0 A 12.0 VDC 1.5 A (QC 18W)
- USB A+C: 5 VDC 3A
- тип конектор: 1 x USB A; 1 x USB C
- средна ефективност в активен режим: 86%
- ефективност при минимално натоварване (10%): 81%
- температура при функциониране 0 °C/+ 45 °C (вътрешно ползване)
- клас IP защита: IP20, само за вътрешно ползване.
- клас на безопасност на устройството II
- защита от пренапрежение (EN 60364-4-44): клас III
- прикрепване на проводниците с винтове макс. 2.5 кв. мм
- устройство с отстояние на контактите мин. 3 мм
- не е подходящо за вграждането в конзоли с дълбочина 45 мм и конзоли за външен монтаж CUBO IP20.
- Съответства на:
- Директиви: BT, EMC, RoHS, ErP
- Стандарти: EN IEC 62368-1, EN 55032, EN55035, EN IEC 61000-3-2, EN 61000-3-3, EN 50563, EN IEC 63000
- Допълнителни регулации: (EU) n. 2019/1782 REACH, n. 1907/2006 – чл. 33.
- Изделието може да съдържа следи от олово.



USB POWER SUPPLY UNIT PD 20W

- 20 W USB power delivery power supply unit
- for charging of electronic devices via a standard USB port (also compatible with Apple devices)
- power supply: 100-230V~ 50/60Hz
- power consumption: 420mA at 100V~/220mA at 230V~
- standby power consumption: <100mW at 230V~
- Output power: 20 W Max
- Output:
- USB tip C: 5.0 VDC 3.0A; 9.0 VDC 2.2 A; 12.0 VDC 1.67 A (PD 20W)
- USB tip A: 5.0 VDC 3.0A; 9.0 VDC 2.0 A; 12.0 VDC 1.5 A (QC 18W)
- USB A+C: 5 VDC 3A
- connector type: 1x USB A; 1x USB C
- average efficiency in active mode: 86%
- efficiency with low load (10%): 81%
- operating temperature: 0°C/+45°C (indoor use)
- IP protection class: IP20, indoor use only
- class device II
- overvoltage category (EN 60364-4-44): Class III
- screw contacts: max. 2.5 mm²
- device with a contact gap of at least 3mm
- Conformity:
- Directive: BT, EMC, RoHS, ErP
- Standards: EN IEC 62368-1, EN 55032, EN55035, EN IEC 61000-3-2, EN 61000-3-3, EN 50563, EN IEC 63000
- External power supplies regulation: (EU) n. 2019/1782 REACH, n. 1907/2006 – art.33. The product may contain traces of lead.

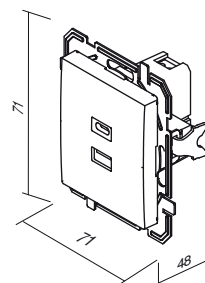

A C C E S S O R I E S P Q

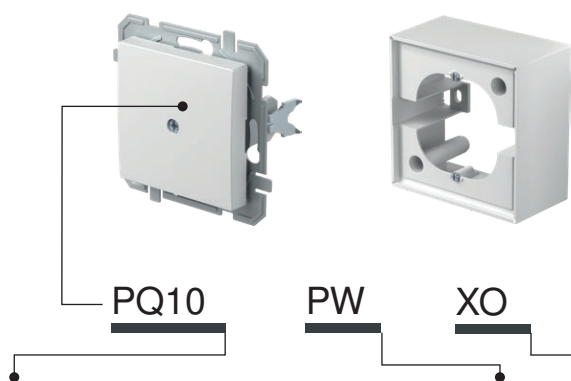

тип type	описание description	цвет colour	допълнителна информация 1 optional data 1
PQ10	КАПАЧЕ BLANK	□ PW полярно бяло polar white	XO без декоративен панел without cover plate
PQ30	ПАНЕЛ TAE/TDO COVER TAE/TDO	■ TI титан titanium ■ AT антрацит anthracite ■ BK черно black	

КАПАЧЕ



- PQ10PWXO
- PQ10TIXO
- PQ10ATXO
- PQ10BKXO

- за запълване на празни позиции
BLANK
- for filling up empty spaces



ПАНЕЛ TAE/TDO

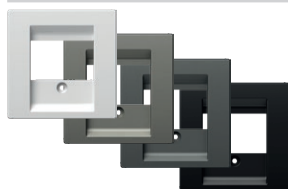

- PQ30PW
- PQ30TI
- PQ30AT
- PQ30BK

- TAE или TDO панел с винт
COVER TAE/TDO
- TAE or TDO cover with screw

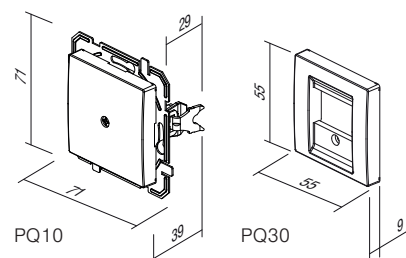

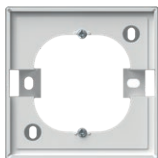

□ PQ20PWF

КОНЗОЛА ЗА ВЪНШЕН МОНТАЖ 1

- конзола за външен монтаж FLAT

SURFACE MOUNT BOX 1

- *surface mounting box FLAT*

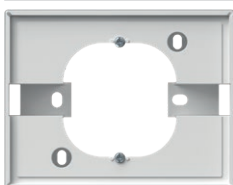

□ PQ21PWF

КУТИЯ ЗА МОНТАЖ НА ПОВЪРХНОСТИ ЗА ДВОЕН КОНТАКТ

- конзола за външен монтаж FLAT

SURFACE MOUNT BOX FOR DOUBLE SOCKET

- *surface mounting box FLAT*





- PQ22PWF
- PQ22TIF
- PQ22ATF
- PQ22BKF

КОМПЛЕКТ ЗА КЛЮЧОВЕ FLAT IP44

- за вграждане във влажни помещения
- IP44 осигурява защита за ключовете (SQ10, SQ11, SQ22, SQ60, SQ70)
- ключовете и бутоните не са съставна част от комплекта
- рамка FLAT
- в съответствие с IEC 60669-1



SET SWITCHES FLAT IP44

- for usage in humid areas
- IP44 protection provides for LOGIQ switches (SQ10, SQ11, SQ22, SQ60, SQ70)
- switches and buttons are not part of the set
- FLAT cover plate
- in accordance with IEC 60669-1



- PQ23PWF
- PQ23TIF
- PQ23ATF
- PQ23BKF

КОМПЛЕКТ ЗА КОНТАКТИ FLAT IP44

- за вграждане във влажни помещения
- IP44 осигурява защита само в съчетание с контактно гнездо с капаче (VQ11XO, VQ13XO, VQ41XO, VQ43XO)
- контактните гнезда не са част от комплекта
- рамка FLAT
- в съответствие с IEC 60884-1



SOCKETS FLAT IP44



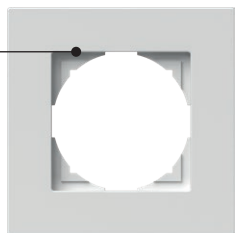

- for usage in humid areas
- IP44 protection can be achieved only in combination with covered socket (VQ11XO, VQ13XO, VQ41XO, VQ43XO)
- sockets are not part of the set
- FLAT cover plate
- in accordance with IEC 60884-1

П А Н Е Л И F L A T О F







OF10

PW

тип type	описание description	цвет colour
OF10	ПАНЕЛ FLAT 1 COVER PLATE FLAT 1	 PW полярно бяло polar white
OF20	ПАНЕЛ FLAT 2 COVER PLATE FLAT 2	 TI титан titanium
OF30	ПАНЕЛ FLAT 3 COVER PLATE FLAT 3	 AT антрацит anthracite
:	:	 BK черно black
:	:	

ПАНЕЛ FLAT 1



	OF10PW
	OF10TI
	OF10AT
	OF10BK



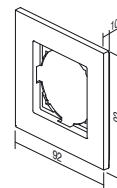

- декоративен панел 1-gang
- в съответствие с EN 60669-1

COVER PLATE FLAT 1
- decorative cover plate 1-gang
- in accordance with EN 60669-1



ПАНЕЛ FLAT 2



	OF20PW
	OF20TI
	OF20AT
	OF20BK

- декоративен панел 2-gang
- в съответствие с EN 60669-1



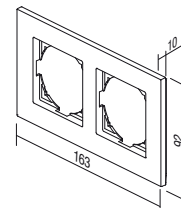

COVER PLATE FLAT 2
- decorative cover plate 2-gang
- in accordance with EN 60669-1



COVER PLATES FLAT OF

ПАНЕЛ FLAT 3



	OF30PW
	OF30TI
	OF30AT
	OF30BK



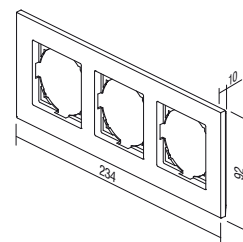

- декоративен панел 3-gang
- в съответствие с EN 60669-1

COVER PLATE FLAT 3
- decorative cover plate 3-gang
- in accordance with EN 60669-1



ПАНЕЛ FLAT 4



	OF40PW
	OF40TI
	OF40AT
	OF40BK



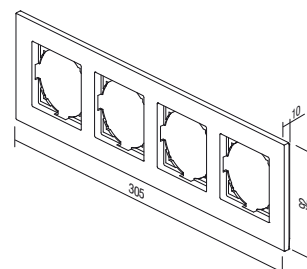

- декоративен панел 4-gang
- в съответствие с EN 60669-1

COVER PLATE FLAT 4
- decorative cover plate 4-gang
- in accordance with EN 60669-1

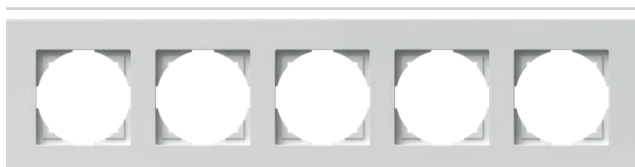

ПАНЕЛ FLAT 5



	OF50PW
	OF50TI
	OF50AT
	OF50BK

- декоративен панел 5-gang
- в съответствие с EN 60669-1

COVER PLATE FLAT 5
- decorative cover plate 5-gang
- in accordance with EN 60669-1

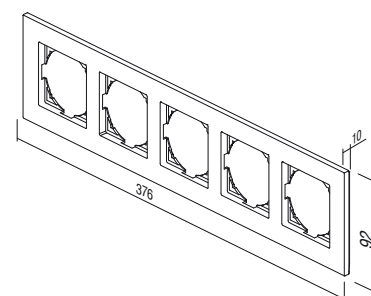

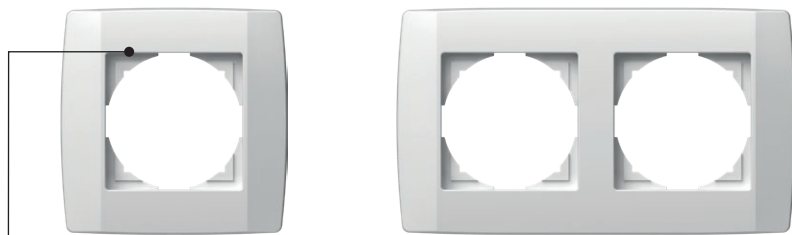

OQ10

PW

тип type	описание description	цвет colour
OQ10	ПАНЕЛ BOLD 1 COVER PLATE BOLD 1	PW полярно бяло polar white
OQ20	ПАНЕЛ BOLD 2 COVER PLATE BOLD 2	TI титан titanium
OQ30	ПАНЕЛ BOLD 3 COVER PLATE BOLD 3	AT антрацит anthracite
:	:	BK черно black
:	:	

ПАНЕЛ BOLD 1



- OQ10PW
- OQ10TI
- OQ10AT
- OQ10BK

- декоративен панел 1-gang
- в съответствие с EN 60669-1
COVER PLATE BOLD 1
- decorative cover plate 1-gang
- in accordance with EN 60669-1

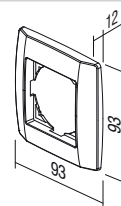

ПАНЕЛ BOLD 2



- OQ20PW
- OQ20TI
- OQ20AT
- OQ20BK

- декоративен панел 2-gang
- в съответствие с EN 60669-1
COVER PLATE BOLD 2
- decorative cover plate 2-gang
- in accordance with EN 60669-1

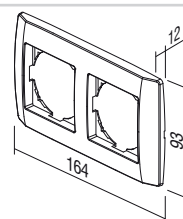

COVER PLATES BOLD OQ

ПАНЕЛ BOLD 3



	OQ30PW
	OQ30TI
	OQ30AT
	OQ30BK

- декоративен панел 3-gang
- в съответствие с EN 60669-1

COVER PLATE BOLD 3
- decorative cover plate 3-gang
- in accordance with EN 60669-1

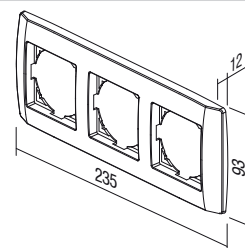

ПАНЕЛ BOLD 4



	OQ40PW
	OQ40TI
	OQ40AT
	OQ40BK

- декоративен панел 4-gang
- в съответствие с EN 60669-1

COVER PLATE BOLD 4
- decorative cover plate 4-gang
- in accordance with EN 60669-1

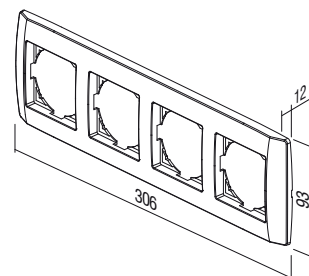

ПАНЕЛ BOLD 5



	OQ50PW
	OQ50TI
	OQ50AT
	OQ50BK

- декоративен панел 5-gang
- в съответствие с EN 60669-1

COVER PLATE BOLD 5
- decorative cover plate 5-gang
- in accordance with EN 60669-1

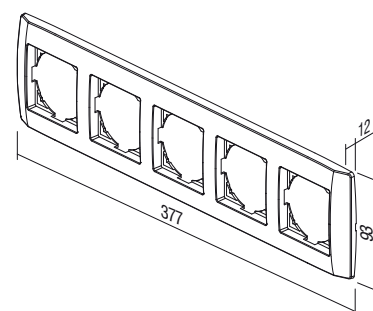

П А Н Е Л И П R I M E О R



OR10

PW

тип type	описание description	ЦВЯТ colour
OR10	ПАНЕЛ PRIME 1 COVER PLATE PRIME 1	 GL бяло glass light
OR20	ПАНЕЛ PRIME 2 COVER PLATE PRIME 2	 GD черно glass dark
OR30	ПАНЕЛ PRIME 3 COVER PLATE PRIME 3	
⋮	⋮	
⋮	⋮	

ПАНЕЛ PRIME 1

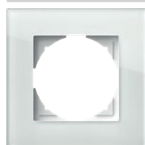

 OR10GL
 OR10GD

- декоративен панел 1-gang
- в съответствие с EN 60669-1

COVER PLATE PRIME 1
- decorative cover plate 1-gang
- in accordance with EN 60669-1

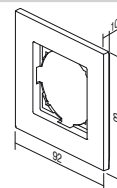

ПАНЕЛ PRIME 2



 OR20GL
 OR20GD

- декоративен панел 2-gang
- в съответствие с EN 60669-1

COVER PLATE PRIME 2
- decorative cover plate 2-gang
- in accordance with EN 60669-1

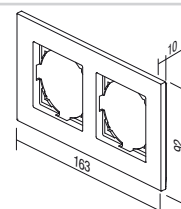

C O V E R P L A T E S P R I M E O R



OR30GL
 OR30GD

ПАНЕЛ PRIME 3

- декоративен панел 3-gang
 - в съответствие с EN 60669-1

COVER PLATE PRIME 3

- decorative cover plate 3-gang
 - in accordance with EN 60669-1

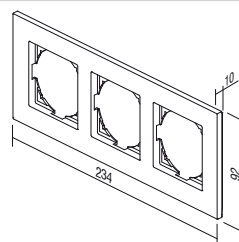

OR40GL
 OR40GD

ПАНЕЛ PRIME 4

- декоративен панел 4-gang
 - в съответствие с EN 60669-1

COVER PLATE PRIME 4

- decorative cover plate 4-gang
 - in accordance with EN 60669-1

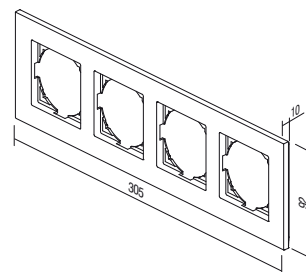

TEM

ekonomik





ekonomik

ПЛАНИРАНИ ЗА ПОСТИГАНЕ НА СЪВЪРШЕНСТВО **Стилът е важен**

Неутрален, компактен, елегантен стил, който се вписва във всяка работна или жилищна зона. В интериора нищо не се набива в очи, а по-скоро хармонично му пасва.

PLANNED FOR EXCELLENCE **Style is essential**

A neutral, compact, elegant design is adjustable to every working or living area. It does not stick out from the interior, but rather harmonically fits into it.





ekonomik

ХАРМОНИЯ НА ЦВЕТОВЕТЕ Изберете своя нюанс

Желанията могат да бъдат най-различни. Затова ние внимателно сме подбрали възможности за вас, които може да ви предоставят правилния отговор. Неутрална палитра от цветове само ще допълни вашата среда – а няма да я ограничава.

HARMONY OF COLOURS Choose your hue

Desires can be very different. Therefore we have carefully selected possibilities for you, which can offer you the right answer. A neutral palette of colours will only complement your ambient - it will not restrict it.

- | | | |
|-----------------------------|--------------------------|------------------------|
| <input type="checkbox"/> PW | полярно бяло | <i>polar white</i> |
| <input type="checkbox"/> IW | слонова кост | <i>ivory white</i> |
| <input type="checkbox"/> ES | елоксирано сребро | <i>elox silver</i> |
| <input type="checkbox"/> CO | термоактивно бяло | <i>white thermoset</i> |
| <input type="checkbox"/> NB | нощно черно | <i>night black</i> |





ОПТОСТЕНО ЗА НАЙ-ВЗИСКАТЕЛНИТЕ

Чрез грижливо планиране елементите под напрежение са защитени срещу докосване. Основното закрепване на механизмите чрез закрепващи крачета (1) дава възможност за допълнително заздравяване с винтове (2). Този начин е особено подходящ за безопасно и надеждно закрепване на контакти.

SIMPLE FOR THE MOST DEMANDING

By careful planning elements under voltage have been protected against touching. Basic fixing of mechanisms with fixing claws (1) allows additional strengthening with screws (2). This manner is especially appropriate for safe and reliable fixing of sockets.

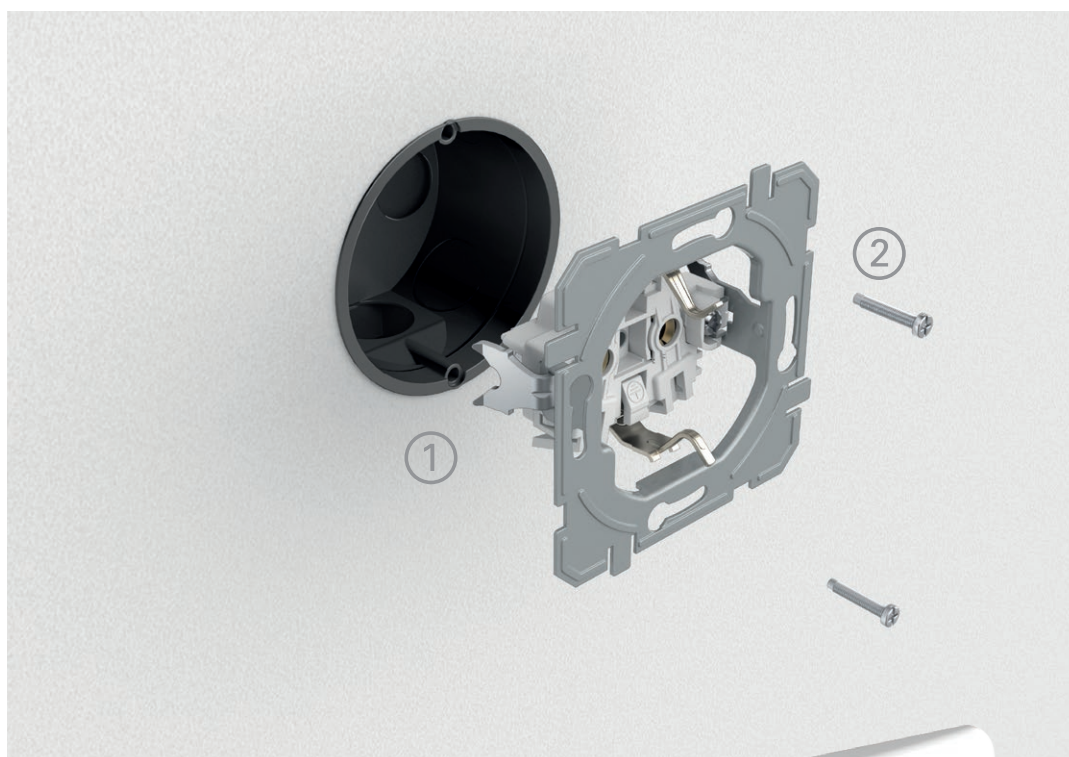

КОМБИНИРАЙТЕ КАКТО ВИ СЕ ИСКА.
COMBINE AS YOU PLEASE.

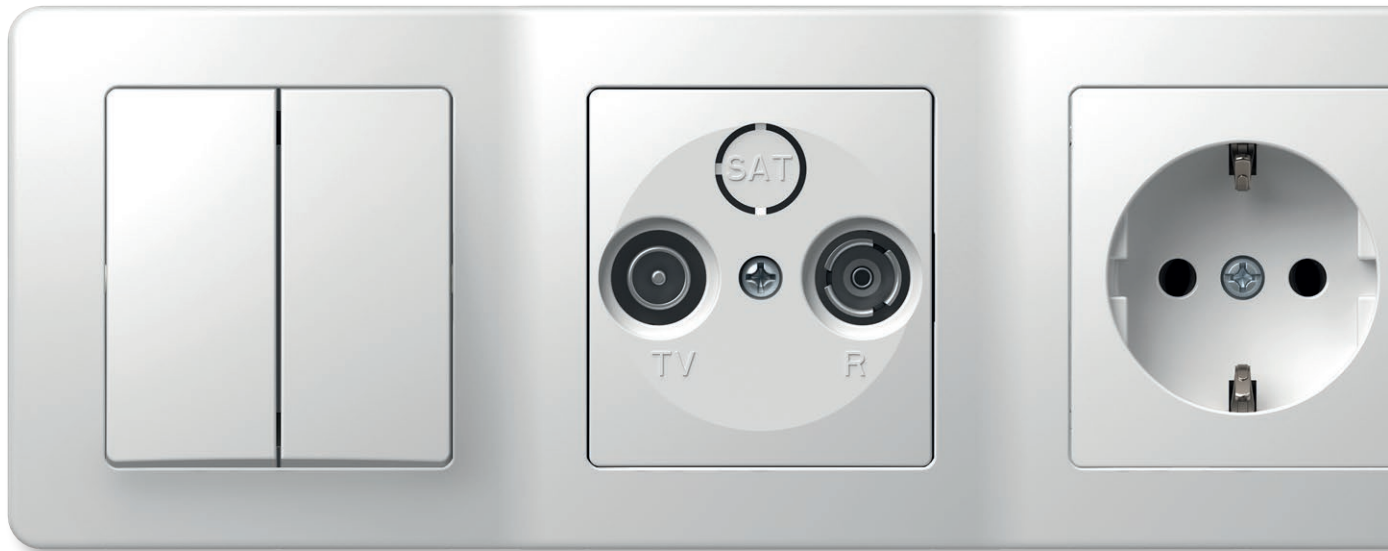

Комбинирайки, вие икономисвате място върху стената. Когато се сблъсквате с ограничено място, »вертикално« е правилното решение.

With combining you save space on the wall. When faced with a limited space, »vertically« is the right decision.

ЛЕСЕН МОНТАЖ

Економик е решение за системата от стандартизирани кръгли инсталационни кутии. Може да се използва както за прости, така и за по-взискателни инсталации, нови сгради и приспособления. Системата се характеризира с контакти чрез вкарване, които спестяват време при монтажа на елементите.

EASY INSTALLATION

Ekonomik is a solution for the system of standardized round installations boxes. It can be used for simple as well as more demanding installations, new buildings and adaptations. The system is characterised by plug-in contacts which save time during installation of elements.

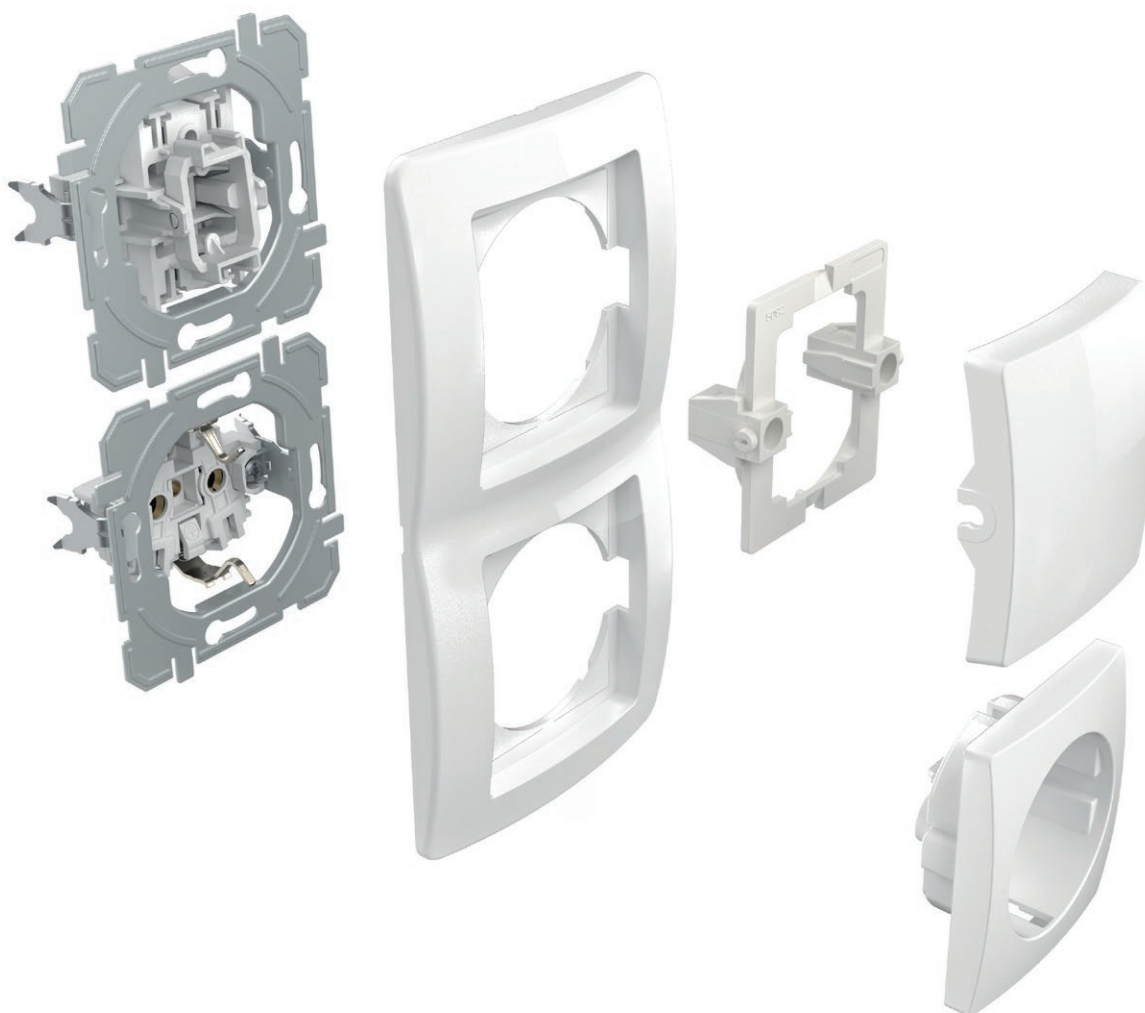

ДОБРЕ Е ДА ЗНАЕТЕ

GOOD TO KNOW



Всички контакти са оборудвани за безопасно изключване, което гарантира защитата на контактите, които са под напрежение.

All the sockets are equipped with a safety shutters assuring the protection to live contacts.



Добре обмислената конструкция на ключа позволява и допълнително лесна индикация.

The well-thought-out design of the switch enables the easy integration of the indication, including at a later time.



Надеждността на превключването се гарантира от контакти от сребърна сплав.

Contacts made of silver alloy guarantee safe switching.



Контактите, осъществявани чрез вкарване на проводниците, позволява бързо и надеждно закрепване на проводниците. Два проводника с различни диаметри може да се свържат към един и същи контакт.

Plug-in contacts enable quick and reliable attachment of wires. Two wires of different diameters can be attached to the same contact.



Закрепващите крачета дават възможност за по-дълбоко закрепване (също така и през керамични плочки и подобни)

Fixing claws enable deeper fixing (also through ceramic tiles, etc.)



Лесните за монтиране инсталационни конзоли ще улеснят работата ви. Правилните дължини са гарантирани.

Easy-fitting installation boxes will make your work easier. Proper lengths are guaranteed.

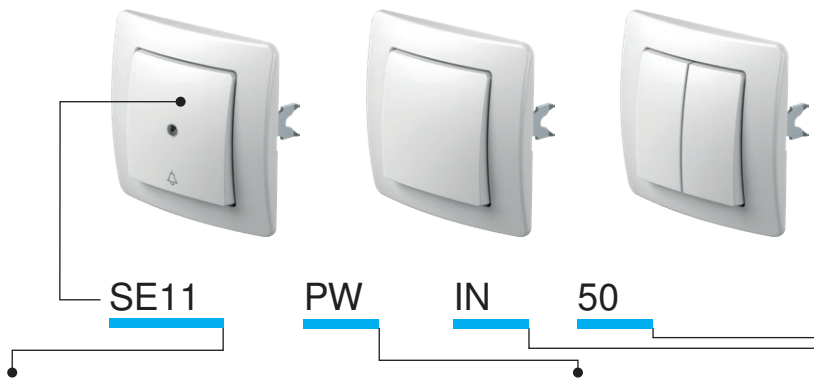

тип type	описание description	технически данни technical data	цвет colour	допълнителна информация 1 optional data 1	допълнителна информация 2 optional data 2
SE10	КЛЮЧ 1WAY SWITCH 1WAY	10AX 250V~	<input type="checkbox"/> PW снежнобял цвят polar white	NT неутрален neutral	50
SE11	БУТОН 1WAY PUSH BUTTON 1WAY	10A 250V~	<input type="checkbox"/> IW слонова кост ivory white		51
SE22	КЛЮЧ 2POLE SWITCH 2POLE	16AX 250V~	<input type="checkbox"/> ES сребрист elox silver <input type="checkbox"/> CO бял с термореактивен материал white thermoset	IN индикатор indicator	03 04
...	<input type="checkbox"/> NB тъмночерен night black		...

КЛЮЧ 1WAY 10AX 250V~

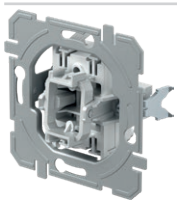

SE10

- 10AX 250V~, тип SE10
- в съответствие с EN 60669-1
- контакти чрез вкарване 1,5 - 2,5 mm²



- SWITCH 1WAY 10AX 250V~
- 10AX 250V~, type SE10
 - in accordance with EN 60669-1
 - plug-in contacts 1.5-2.5mm²

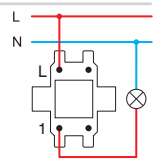

БУТОН 1WAY 10A 250V~

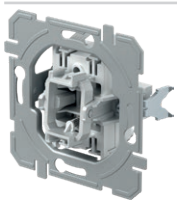

SE11

- 10A 250V~, тип SE11
- в съответствие с EN 60669-1
- контакти чрез вкарване 1,5 - 2,5 mm²



- PUSH BUTTON 1WAY 10A 250V~
- 10A 250V~, type SE11
 - in accordance with EN 60669-1
 - plug-in contacts 1.5-2.5mm²

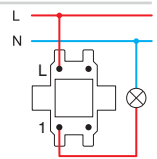

КЛЮЧ 2POLE 16AX 250V~

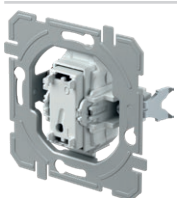

SE22

- 16AX 250V~, тип SE22
- в съответствие с EN 60669-1
- винтови контакти 1,5 - 2,5 mm²
- само в комбинация с бутон TE10__NT03

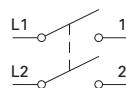

- SWITCH 2POLE 16AX 250V~
- 16AX 250V~, type SE22
 - in accordance with EN 60669-1
 - screw contacts 1.5-2.5mm²
 - only in combination with button TE10__NT03

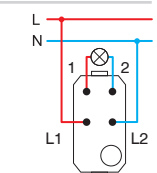

КЛЮЧ 2GANG-1WAY 10AX 250V~

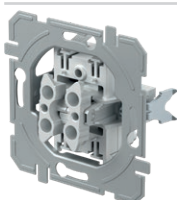

SE50

- 10AX 250V~, тип SE50
- в съответствие с EN 60669-1
- контакти чрез вкарване 1,5 - 2,5 mm²

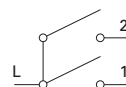

- SWITCH 2GANG-1WAY 10AX 250V~
- 10AX 250V~, type SE50
 - in accordance with EN 60669-1
 - plug-in contacts 1.5-2.5mm²

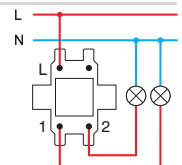

S W I T C H E S S E

БУТОН 2GANG-1WAY 10A 250V~

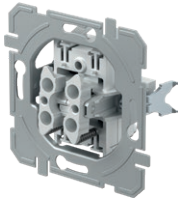

SE51

- 10 A 250 V~, тип SE51
- в съответствие с EN 60669-1
- контакти чрез вкарване 1,5 - 2,5 mm²

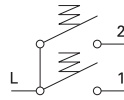
*PUSH BUTTON 2GANG-1WAY 10A 250V~*

- 10A 250V~, type SE51
- in accordance with EN 60669-1
- plug-in contacts 1.5-2.5mm²

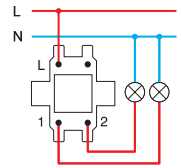

КЛЮЧ ЗА ЩОРИ 10AX 250V~

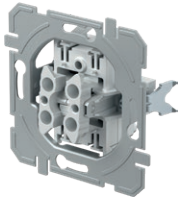

SE52

- 10AX 250 V~, тип SE52
- в съответствие с EN 60669-1
- контакти чрез вкарване 1,5 - 2,5 mm²
- с механична блокировка

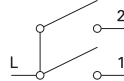
*SWITCH SHUTTERS 10AX 250V~*

- 10AX 250V~, type SE52
- in accordance with EN 60669-1
- plug-in contacts 1.5-2.5mm²
- with mechanical interblock

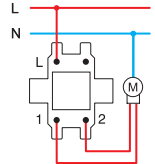

БУТОН ЗА ЩОРИ 10A 250V~

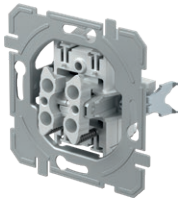

SE53

- 10A 250V~, тип SE53
- в съответствие с EN 60669-1
- контакти чрез вкарване 1,5 - 2,5 mm²
- с механична блокировка

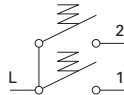
*PUSH BUTTON SHUTTERS 10A 250V~*

- 10A 250V~, type SE53
- in accordance with EN 60669-1
- plug-in contacts 1.5-2.5mm²
- with mechanical interblock

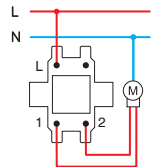

КЛЮЧ 2WAY 10AX 250V~

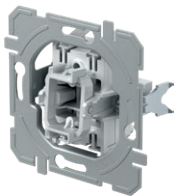

SE60

- 10AX 250V~, тип SE60
- в съответствие с EN 60669-1
- контакти чрез вкарване 1,5 - 2,5 mm²

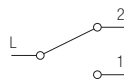
*SWITCH 2WAY 10AX 250V~*

- 10AX 250V~, type SE60
- in accordance with EN 60669-1
- plug-in contacts 1.5-2.5mm²

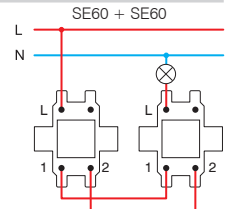

ДВОЕН КЛЮЧ 2WAY 10AX 250V~

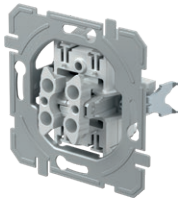

SE63

- 10AX 250V~, тип SE63
- в съответствие с EN 60669-1
- контакти чрез вкарване 1,5 - 2,5 mm²

*SWITCH DOUBLE 2WAY 10AX 250V~*

- 10AX 250V~, type SE63
- in accordance with EN 60669-1
- plug-in contacts 1.5-2.5mm²

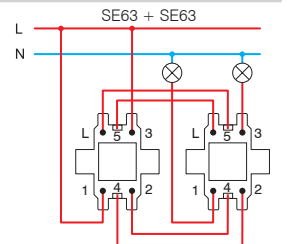

КРЪСТАТ КЛЮЧ 10AX 250V~

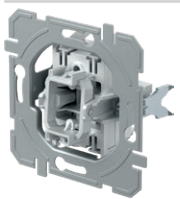

SE70

- 10AX 250V~, тип SE70
- в съответствие с EN 60669-1
- контакти чрез вкарване 1,5 - 2,5 mm²

*SWITCH INTERMEDIATE 10AX 250V~*

- 10AX 250V~, type SE70
- in accordance with EN 60669-1
- plug-in contacts 1.5-2.5mm²

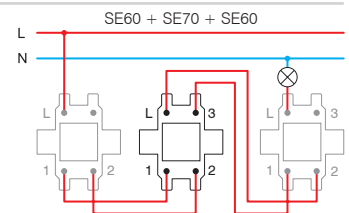

КЛЮЧ 1WAY 10AX 250V~



- SE10PW
- SE10IW
- SE10ES
- SE10CO
- SE10NB

- 10AX 250V~, тип SE10
 - в съответствие с EN 60669-1
 - контакти чрез вкарване 1,5 - 2,5 mm²

SWITCH 1WAY 10AX 250V~
 - 10AX 250V~, type SE10
 - in accordance with EN 60669-1
 - plug-in contacts 1.5-2.5mm²



КЛЮЧ 1WAY 10AX 250V~ __ IN



- SE10PWIN
- SE10IWIN
- SE10ESIN
- SE10COIN
- SE10NBIN

- IN индикатор
 - 10AX 250V~, тип SE10
 - в съответствие с EN 60669-1
 - контакти чрез вкарване 1,5 - 2,5 mm²

SWITCH 1WAY 10AX 250V~ __ IN
 - IN indicator
 - 10AX 250V~, type SE10
 - in accordance with EN 60669-1
 - plug-in contacts 1.5-2.5mm²



БУТОН 1WAY 10A 250V~



- SE11PW
- SE11IW
- SE11ES
- SE11CO
- SE11NB

- 10A 250V~, тип SE11
 - в съответствие с EN 60669-1
 - контакти чрез вкарване 1,5 - 2,5 mm²

PUSH BUTTON 1WAY 10A 250V~
 - 10A 250V~, type SE11
 - in accordance with EN 60669-1
 - plug-in contacts 1.5-2.5mm²



БУТОН 1WAY 10A 250V~ __ TI 50



- SE11PWTI50
- SE11IWTI50
- SE11ESTI50
- SE11COTI50
- SE11NBTI50

- TI 50 звънчев индикатор+неонова лампа
 - 10A 250V~, тип SE11
 - в съответствие с EN 60669-1
 - контакти чрез вкарване 1,5 - 2,5 mm²

PUSH BUTTON 1WAY 10A 250V~ __ TI 50
 - TI 50 indicator bell+neon lamp
 - 10A 250V~, type SE11
 - in accordance with EN 60669-1
 - plug-in contacts 1.5-2.5mm²



БУТОН 1WAY 10A 250V~ __ TI 51



- SE11PWTI51
- SE11IWTI51
- SE11ESTI51
- SE11COTI51
- SE11NBTI51

- TI 51 светлинен индикатор+неонова лампа
 - 10A 250V~, тип SE11
 - в съответствие с EN 60669-1
 - контакти чрез вкарване 1,5 - 2,5 mm²

PUSH BUTTON 1WAY 10A 250V~ __ TI 51
 - TI 51 indicator light+neon lamp
 - 10A 250V~, type SE11
 - in accordance with EN 60669-1
 - plug-in contacts 1.5-2.5mm²



БУТОН 1WAY 10A 250V~ __ IL



- SE11PWIL
- SE11IWIL
- SE11ESIL
- SE11COIL
- SE11NBIL

- IL панел с надпис
 - 10A 250V~, тип SE11
 - в съответствие с EN 60669-1
 - контакти чрез вкарване 1,5 - 2,5 mm²

PUSH BUTTON 1WAY 10A 250V~ __ IL
 - IL inscription plate
 - 10A 250V~, type SE11
 - in accordance with EN 60669-1
 - plug-in contacts 1.5-2.5mm²



КЛЮЧ 2POLE 16AX 250V~ __ IN 03



- SE22PWIN03
- SE22IWIN03
- SE22ESIN03
- SE22NBIN03

- IN 03 неутрално положение 0-1
 - 16AX 250V~, тип SE22
 - в съответствие с EN 60669-1
 - винтови контакти 1,5 - 2,5 mm²

SWITCH 2POLE 16AX 250V~ __ IN 03
 - IN 03 neutral 0-1
 - 16AX 250V~, type SE22
 - in accordance with EN 60669-1
 - screw contacts 1.5-2.5mm²



S W I T C H E S S E



- SE50PW
- SE50IW
- SE50ES
- SE50CO
- SE50NB

КЛЮЧ 2GANG-1WAY 10AX 250V~

- 10AX 250V~, тип SE50
- в съответствие с EN 60669-1
- контакти чрез вкарване 1,5 - 2,5 mm²

SWITCH 2GANG-1WAY 10AX 250V~

- 10AX 250V~, type SE50
- in accordance with EN 60669-1
- plug-in contacts 1.5-2.5mm²



- SE51PW
- SE51IW
- SE51ES
- SE51CO
- SE51NB

БУТОН 2GANG-1WAY 10A 250V~

- 10 A 250 V~, тип SE51
- в съответствие с EN 60669-1
- контакти чрез вкарване 1,5 - 2,5 mm²

PUSH BUTTON 2GANG-1WAY 10A 250V~

- 10A 250V~, type SE51
- in accordance with EN 60669-1
- plug-in contacts 1.5-2.5mm²



- SE52PWNT09
- SE52IWNT09
- SE52ESNT09
- SE52CONT09
- SE52NBNT09

КЛЮЧ ЗА ЩОРИ 10AX 250V~ __ NT 09

- NT 09 неутрално положение – нагоре-надолу
- 10AX 250 V~, тип SE52
- в съответствие с EN 60669-1
- контакти чрез вкарване 1,5 - 2,5 mm²
- с механична блокировка

SWITCH SHUTTERS 10AX 250V~ __ NT 09

- NT 09 neutral up-down
- 10AX 250V~, type SE52
- in accordance with EN 60669-1
- plug-in contacts 1.5-2.5mm²
- with mechanical interblock



- SE53PWNT09
- SE53IWNT09
- SE53ESNT09
- SE53CONT09
- SE53NBNT09

БУТОНИ ЗА ЩОРИ 10A 250V~ __ NT 09

- NT 09 неутрално положение – нагоре-надолу
- 10 A 250 V~, тип SE53
- в съответствие с EN 60669-1
- контакти чрез вкарване 1,5 - 2,5 mm²
- с механична блокировка

PUSH BUTTON SHUTTERS 10A 250V~ __ NT 09

- NT 09 neutral up-down
- 10A 250V~, type SE53
- in accordance with EN 60669-1
- plug-in contacts 1.5-2.5mm²
- with mechanical interblock



- SE60PW
- SE60IW
- SE60ES
- SE60CO
- SE60NB

КЛЮЧ 2WAY 10AX 250V~

- 10AX 250V~, тип SE60
- в съответствие с EN 60669-1
- контакти чрез вкарване 1,5 - 2,5 mm²

SWITCH 2WAY 10AX 250V~

- 10AX 250V~, type SE60
- in accordance with EN 60669-1
- plug-in contacts 1.5-2.5mm²



- SE63PW
- SE63IW
- SE63ES
- SE63CO
- SE63NB

ДВОЕН КЛЮЧ 2WAY 10AX 250V~

- 10AX 250V~, тип SE63
- в съответствие с EN 60669-1
- контакти чрез вкарване 1,5 - 2,5 mm²

SWITCH DOUBLE 2WAY 10AX 250V~

- 10AX 250V~, type SE63
- in accordance with EN 60669-1
- plug-in contacts 1.5-2.5mm²



- SE70PW
- SE70IW
- SE70ES
- SE70CO
- SE70NB

КРЪСТАТ КЛЮЧ 10AX 250V~

- 10AX 250V~, тип SE70
- в съответствие с EN 60669-1
- контакти чрез вкарване 1,5 - 2,5 mm²

SWITCH INTERMEDIATE 10AX 250V~

- 10AX 250V~, type SE70
- in accordance with EN 60669-1
- plug-in contacts 1.5-2.5mm²

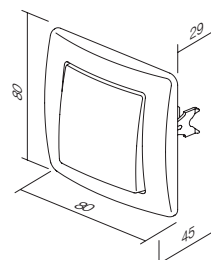
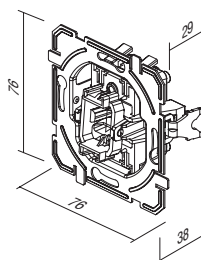

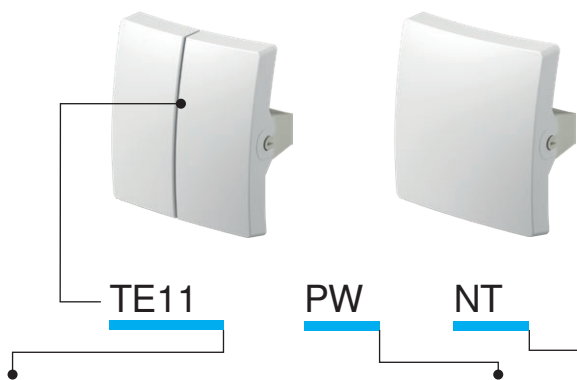

тип type	описание description	цвет colour	допълнителна информация 1 optional data 1	допълнителна информация 2 optional data 2
TE10	БУТОН 1GANG BUTTON 1GANG	<input type="checkbox"/> PW снежнобял цвет polar white	NT с неутрално положение neutral	50
TE11	БУТОН 2GANG BUTTON 2GANG	<input type="checkbox"/> IW слонова кост ivory white	IN индикатор indicator	51
...	...	<input type="checkbox"/> ES сребрист elox silver		03
...	...	<input type="checkbox"/> CO бял с термореактивен материал white thermoset		04
...	...	<input type="checkbox"/> NB тъмночерен night black		

БУТОН 1GANG



- TE10PW
- TE10IW
- TE10ES
- TE10CO
- TE10NB

- бутон заедно с носач
BUTTON 1GANG
- button together with carrier



БУТОН С ИНДИКАТОР

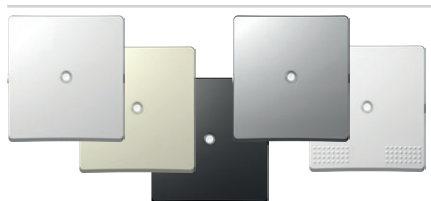

- TE10PWIN
- TE10IWIN
- TE10ESIN
- TE10COIN
- TE10NBIN

- бутон заедно с носач
BUTTON INDICATOR
- button together with carrier



БУТОН С ПАНЕЛ С НАДПИС

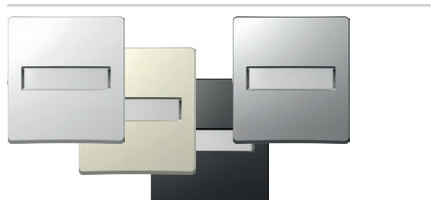

- TE13PWIL
- TE13IWIL
- TE13ESIL
- TE13NBIL

- бутон заедно с носач, с панел с надпис
BUTTON WITH INSCRIPTION PLATE
- button together with carrier, with inscription plate



БУТОН 2GANG



- TE11PW
- TE11IW
- TE11ES
- TE11CO
- TE11NB

- бутон 2gang с носач
BUTTON 2GANG
- button 2gang together with carrier

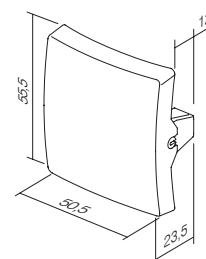
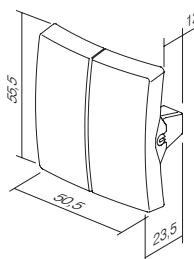

S I G N A L I Z A T I O N I A

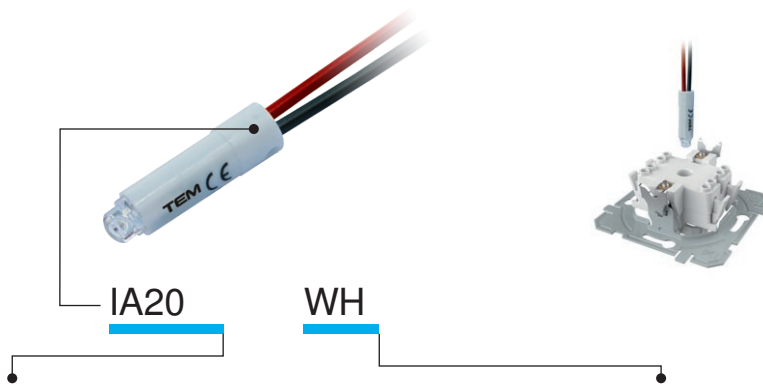

тип type	описание description	технически данни technical data	цвет colour
IA10	НЕОНОВА ЛАМПА NEON LAMP	230V~ 0,34W	<input type="checkbox"/> WH бял цвят white
IA20	СВЕТОДИОДНА СИГНАЛИЗАЦИЯ LED SIGNALLING UNIT	230V~ 0,40W	<input checked="" type="checkbox"/> BL син цвят blue
IA21	СВЕТОДИОДНА СИГНАЛИЗАЦИЯ LED SIGNALLING UNIT	24V AC/DC 0,20W	<input checked="" type="checkbox"/> RD червен red
·	·	·	<input checked="" type="checkbox"/> GR зелен green
·	·	·	<input checked="" type="checkbox"/> OR оранжев orange

НЕОНОВА ЛАМПА 230 V~ 0,34 W

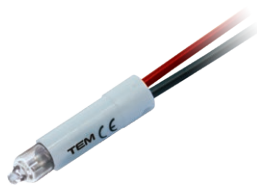

 IA10OR

- за индикиране, сигнализация или постоянна сигнализация;
- в съчетание с бутон с индикатор

NEON LAMP 230V~ 0,34W

- for indication, signalling or permanent signalling
- in combination with a button featuring an indicator

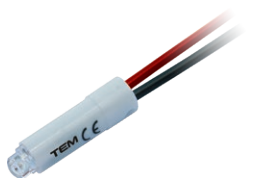
СВЕТОДИОДНА СИГНАЛИЗАЦИЯ 230 V AC/DC 0,40 W



 IA20WH
 IA20GR
 IA20RD
 IA20BL

- за индикиране, сигнализация или постоянна сигнализация;
- в съчетание с бутон с индикатор

LED SIGNALLING UNIT 230V AC/DC 0,40W

- for indication, signalling or permanent signalling
- in combination with a button featuring an indicator

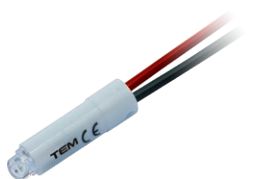
СВЕТОДИОДНА СИГНАЛИЗАЦИЯ 24V AC/DC 0,20W



 IA21WH
 IA21RD

- за индикиране, сигнализация или постоянна сигнализация;
- в съчетание с бутон с индикатор

LED SIGNALLING UNIT 24V AC/DC 0,20W

- for indication, signalling or permanent signalling
- in combination with a button featuring an indicator

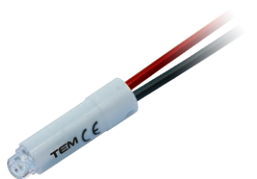
СВЕТОДИОДНА СИГНАЛИЗАЦИЯ 12V AC/DC 0,10W

 IA22WH
 IA22RD

- за индикиране, сигнализация или постоянна сигнализация;
- в съчетание с бутон с индикатор

LED SIGNALLING UNIT 12V AC/DC 0,10W

- for indication, signalling or permanent signalling
- in combination with a button featuring an indicator

Индикация /
Indication

* Сигнализация /
Signalization

Постоянна сигнализация /
Permanent signalling

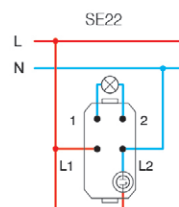
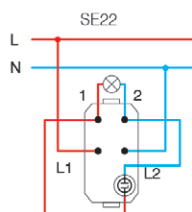
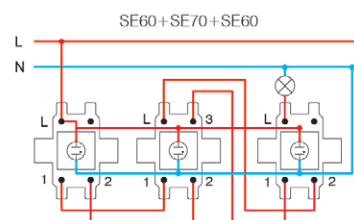
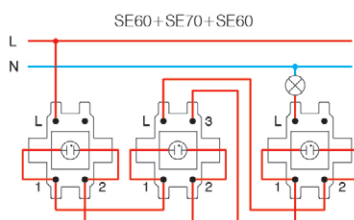
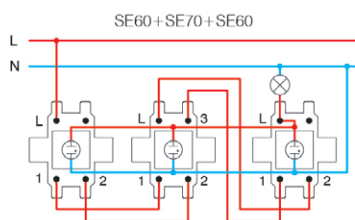
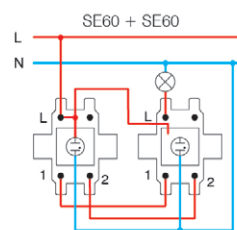
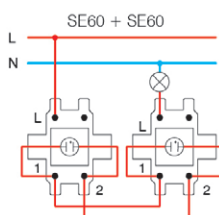
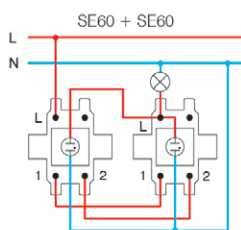
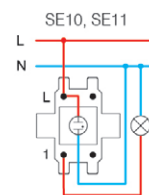
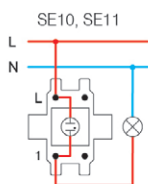
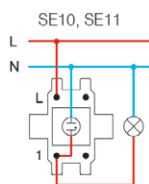

* връзките не са подходящи за енергоспестяващи крушки (CFL, LED) /
the connections are not suitable for energy-saving bulbs (CFL, LED)

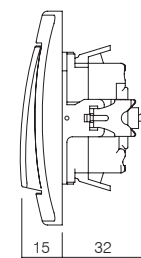

S O C K E T S V E

VE11 **PT** **XO** **KS**

тип type	описание description	технически данни technical data	допълнителна информация 1 optional data 1	допълнителна информация 2 optional data 2
VE10	КОНТАКТ ШУКО SOCKET SCHUKO	2P+E 16A 250V~	XO без декоративен панел without cover plate	KS Вградена защита от допир на контакти shuttered live contacts
VE11	КОНТАКТ ШУКО+КАПАК SOCKET SCHUKO+COVER	2P+E 16A 250V~		
VE12	КОНТАКТ ШУКО SOCKET SCHUKO	2P+E 16A 250V~ BV	KS Вградена защита от допир на контакти shuttered live contacts	
⋮	⋮	⋮		

ЦВЯТ
colour

<input type="checkbox"/> PW	снежнобял цвят polar white	<input checked="" type="checkbox"/> PT	бял + прозрачен white+transparent	<input type="checkbox"/> PP	бял + бял white+white
<input checked="" type="checkbox"/> IW	слонова кост ivory white	<input checked="" type="checkbox"/> IT	слонова кост + прозрачен ivory+transparent	<input checked="" type="checkbox"/> II	слонова кост + слонова кост ivory+ivory
<input type="checkbox"/> ES	сребрист elix silver	<input checked="" type="checkbox"/> ST	сребрист + прозрачен silver+transparent	<input type="checkbox"/> SS	сребрист + сребрист silver+silver
<input type="checkbox"/> CO	бял с термореактивен материал white thermoset	<input type="checkbox"/> CT	бял + прозрачен white+transparent	<input checked="" type="checkbox"/> BB	черен + черен black+black
<input checked="" type="checkbox"/> NB	тъмночерен night black	<input checked="" type="checkbox"/> BT	черен + прозрачен black+transparent	<input checked="" type="checkbox"/> RR	червен + червен red+red
<input checked="" type="checkbox"/> RD	червен red	<input checked="" type="checkbox"/> RT	червен + прозрачен red+transparent	<input checked="" type="checkbox"/> GG	зелен + зелен green+green
<input checked="" type="checkbox"/> GR	зелен green	<input checked="" type="checkbox"/> GT	зелен + прозрачен green+transparent	<input checked="" type="checkbox"/> OO	оранжев + оранжев orange+orange
<input checked="" type="checkbox"/> OR	оранжев orange	<input checked="" type="checkbox"/> OT	оранжев + прозрачен orange+transparent		



Шуко – в съответствие с EN 60884-1, CEE7 (лист със стандарти III)

schuko - in accordance with EN 60884-1, CEE7 (standard sheet III)

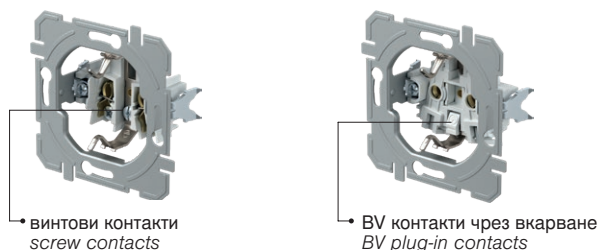

Френски – в съответствие с NF C 61-314 (лист със стандарти V)

French - in accordance with NF C 61-314 (standard sheet V)

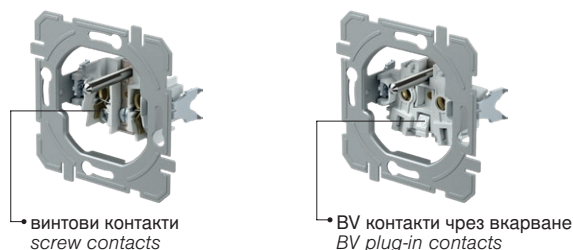

КОНТАКТ ШУКО 2P+E 16A 250V~ __ XO

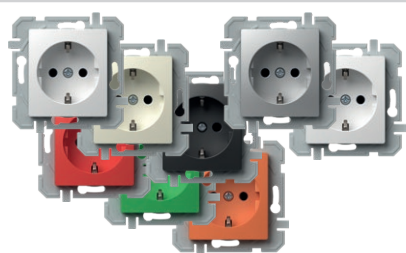

- VE10PWXO
- VE10IWXO
- VE10ESXO
- VE10COXO
- VE10NBXO
- VE10RDXO
- VE10GRXO
- VE10ORXO

- винтови контакти 1,5 - 2,5 mm²
- XO без панел
- 2P+E шуко
- 16A 250V~, тип VE10

SOCKET SCHUKO 2P+E 16A 250V~ __ XO

- screw contacts 1.5-2.5mm²
- XO without surround
- 2P+E schuko
- 16A 250V~, type VE10



КОНТАКТ ШУКО+КАПАК 2P+E 16 A 250 V~ __ XO



- VE11PTXO
- VE11ITXO
- VE11STXO
- VE11BTXO

- винтови контакти 1,5 - 2,5 mm²
- XO без рамка
- 2P+E шуко+капак
- 16 A 250 V~, тип VE11

SOCKET SCHUKO+COVER 2P+E 16A 250V~ __ XO

- screw contacts 1.5-2.5mm²
- XO without surround
- 2P+E schuko+cover
- 16A 250V~, type VE11



КОНТАКТ ШУКО 2P+E 16A 250V~ BV __ XO



- VE12PWXO
- VE12IWXO
- VE12ESXO
- VE12COXO
- VE12NBXO
- VE12RDXO
- VE12GRXO
- VE12ORXO

- BV контакти чрез вкарване 1,5 - 2,5 mm²
- XO без панел
- 2P+E шуко
- 16A 250V~, тип VE12

SOCKET SCHUKO 2P+E 16A 250V~ BV __ XO

- BV plug-in contacts 1.5-2.5mm²
- XO without surround
- 2P+E schuko
- 16A 250V~, type VE12



КОНТАКТ ШУКО+КАПАК 2P+E 16A 250V~ BV __ XO

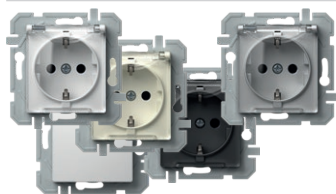

- VE13PTXO
- VE13ITXO
- VE13STXO
- VE13BTXO
- VE13PPXO

- BV контакти чрез вкарване 1,5 - 2,5 mm²
- XO без панел
- 2P+E шуко+капак
- 16A 250V~, тип VE13

SOCKET SCHUKO+COVER 2P+E 16A 250V~ BV __ XO

- BV plug-in contacts 1.5-2.5mm²
- XO without surround
- 2P+E schuko+cover
- 16A 250V~, type VE13



КОНТАКТ ШУКО 2P+E 16A 250V~



- VE10PW
- VE10IW
- VE10ES
- VE10CO
- VE10NB

- винтови контакти 1,5 - 2,5 mm²
- 2P+E шуко
- 16A 250V~, тип VE10

SOCKET SCHUKO 2P+E 16A 250V~

- screw contacts 1.5-2.5mm²
- 2P+E schuko
- 16A 250V~, type VE10



КОНТАКТ ШУКО+КАПАК 2P+E 16A 250V~



- VE11PT
- VE11IT
- VE11ST
- VE11CT
- VE11BT

- винтови контакти 1,5 - 2,5 mm²
- 2P+E шуко+капак
- 16A 250V~, тип VE11

SOCKET SCHUKO+COVER 2P+E 16A 250V~

- screw contacts 1.5-2.5mm²
- 2P+E schuko+cover
- 16A 250V~, type VE11



КОНТАКТ ШУКО 2P+E 16A 250V~ BV



- VE12PW
- VE12IW
- VE12ES
- VE12CO
- VE12NB

- BV контакти чрез вкарване 1,5 - 2,5 mm²
- 2P+E шуко
- 16A 250V~, тип VE12

SOCKET SCHUKO 2P+E 16A 250V~ BV

- BV plug-in contacts 1.5-2.5mm²
- 2P+E schuko
- 16A 250V~, type VE12



КОНТАКТ ШУКО+КАПАК 2P+E 16A 250V~ BV



- VE13PT
- VE13IT
- VE13ST
- VE13CT
- VE13BT

- BV контакти чрез вкарване 1,5 - 2,5 mm²
- 2P+E шуко+капак
- 16A 250V~, тип VE13

SOCKET SCHUKO+COVER 2P+E 16A 250V~ BV

- BV plug-in contacts 1.5-2.5mm²
- 2P+E schuko+cover
- 16A 250V~, type VE13



S O C K E T S V E

КОНТАКТ ФРЕНСКИ 2P+E 16A 250V~ __ XO

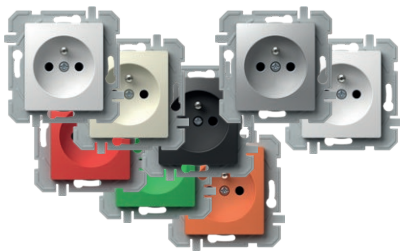

- VE40PWXO - винтови контакти 1,5 - 2,5 mm²
- VE40IWXO - XO без панел
- VE40ESXO - 2P+E френски контакт
- VE40COXO - 16A 250V~, тип VE40
- VE40NBXO - screw contacts 1.5-2.5mm²
- VE40RDXO - XO without surround
- VE40GRXO - 2P+E French
- VE40ORXO - 16A 250V~, type VE40

SOCKET FRENCH 2P+E 16A 250V~ __ XO

- screw contacts 1.5-2.5mm²
- XO without surround
- 2P+E French
- 16A 250V~, type VE40



КОНТАКТ ФРЕНСКИ+КАПАК 2P+E 16A 250V~ __ XO

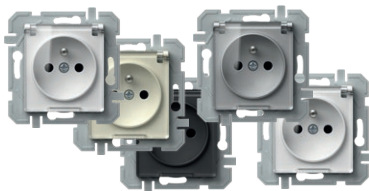

- VE41PTXO - винтови контакти 1,5 - 2,5 mm²
- VE41ITXO - XO без панел
- VE41STXO - 2P+E френски контакт+капак
- VE41BTXO - 16A 250V~, тип VE41

SOCKET FRENCH+COVER 2P+E 16A 250V~ __ XO

- screw contacts 1.5-2.5mm²
- XO without surround
- 2P+E French+cover
- 16A 250V~, type VE41



КОНТАКТ ФРЕНСКИ 2P+E 16A 250V~ BV __ XO

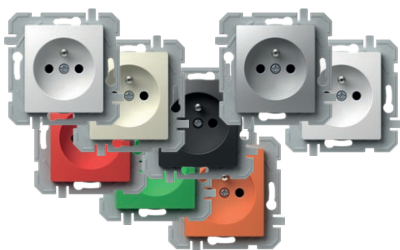

- VE42PWXO - BV контакти чрез вкарване 1,5 - 2,5 mm²
- VE42IWXO - XO без панел
- VE42ESXO - 2P+E френски контакт
- VE42COXO - 16A 250V~, тип VE42
- VE42NBXO - BV plug-in contacts 1.5-2.5mm²
- VE42RDXO - XO without surround
- VE42GRXO - 2P+E French
- VE42ORXO - 16A 250V~, type VE42

SOCKET FRENCH 2P+E 16A 250V~ BV __ XO

- BV plug-in contacts 1.5-2.5mm²
- XO without surround
- 2P+E French
- 16A 250V~, type VE42



КОНТАКТ ФРЕНСКИ+КАПАК 2P+E 16 A 250 V~ BV __ XO



- VE43PTXO - BV контакти чрез вкарване 1,5 - 2,5 mm²
- VE43ITXO - XO без рамка
- VE43STXO - 2P+E френски контакт+капак
- VE43BTXO - 16 A 250 V~, тип VE43

SOCKET FRENCH+COVER 2P+E 16A 250V~ BV __ XO

- BV plug-in contacts 1.5-2.5mm²
- XO without surround
- 2P+E French+cover
- 16A 250V~, type VE43



КОНТАКТ ФРЕНСКИ 2P+E 16A 250V~



- VE40PW - винтови контакти 1,5 - 2,5 mm²
- VE40IW - 2P+E френски контакт
- VE40ES - 16A 250V~, тип VE40
- VE40CO - screw contacts 1.5-2.5mm²
- VE40NB - 2P+E French

SOCKET FRENCH 2P+E 16A 250V~

- screw contacts 1.5-2.5mm²
- 2P+E French
- 16A 250V~, type VE40



КОНТАКТ ФРЕНСКИ+КАПАК 2P+E 16A 250V~



- VE41PT - винтови контакти 1,5 - 2,5 mm²
- VE41IT - 2P+E френски контакт+капак
- VE41BT - 16A 250V~, тип VE41
- VE41ST

SOCKET FRENCH+COVER 2P+E 16A 250V~

- screw contacts 1.5-2.5mm²
- 2P+E French+cover
- 16A 250V~, type VE41



КОНТАКТ ФРЕНСКИ 2P+E 16A 250V~ BV



- VE42PW - BV контакти чрез вкарване 1,5 - 2,5 mm²
- VE42IW - 2P+E френски контакт
- VE42ES - 16A 250V~, тип VE42
- VE42CO - screw contacts 1.5-2.5mm²
- VE42NB - 2P+E French

SOCKET FRENCH 2P+E 16A 250V~ BV

- BV plug-in contacts 1.5-2.5mm²
- 2P+E French
- 16A 250V~, type VE42



КОНТАКТ ФРЕНСКИ+КАПАК 2P+E 16A 250V~ BV



- VE43PT - BV контакти чрез вкарване 1,5 - 2,5 mm²
- VE43IT - 2P+E френски контакт+капак
- VE43BT - 16A 250V~, тип VE43
- VE43ST

SOCKET FRENCH+COVER 2P+E 16A 250V~ BV

- BV plug-in contacts 1.5-2.5mm²
- 2P+E French+cover
- 16A 250V~, type VE43



КОНТАКТ ШУКО DOUBLE 2P+E 16A 250V~



- VE16PWKS
- VE16WKS
- VE16ESKS
- VE16NBKS

- 2P+E шуко двоен, 16A 250V~, тип VE16
 - в съответствие с IEC 60884-1, CEE7
 - винтови контакти 1,5 - 2,5 mm²
 - Вградена защита от допир на контакти

SOCKET SCHUKO DOUBLE 2P+E 16A 250V~

- 2P+E schuko double
 - 16A 250V~, type VE16
 - in accordance with IEC 60884-1, CEE7
 - screw contacts 1.5-2.5 mm²
 - shuttered live contacts



КОНТАКТ ФРЕНСКИ ДВОЕН 2P+E 16A 250V~



- VE46PWKS
- VE46WKS
- VE46ESKS
- VE46NBKS

- 2P+E френски двоен, 16A 250V~, тип VE46
 - в съответствие с IEC 60884-1, CEE7; NF C 61-314, CSN 33 2318; PN-E 93201
 - винтови контакти 1,5 - 2,5 mm²
 - Вградена защита от допир на контакти

SOCKET FRENCH DOUBLE 2P+E 16A 250V~

- 2P+E French double
 - 16A 250V~, type VE46
 - in accordance with IEC 60884-1, CEE7; NF C 61-314, CSN 33 2318; PN-E 93201
 - screw contacts 1.5-2.5 mm²
 - shuttered live contacts



КОНТАКТ 2P 16A 250V~



- VE30PW
- VE30W
- VE30ES
- VE30NB

- 2P без контакт за заземяване
 - 16A 250V~
 - в съответствие с EN 60884-1, CEE7 (лист със стандарти I)
 - винтови контакти 1,5 - 2,5 mm²

SOCKET 2P 16A 250V~

- 2P without earthing contact
 - 16A 250V~
 - in accordance with EN 60884-1, CEE7 (standard sheet I)
 - screw contacts 1.5-2.5mm²

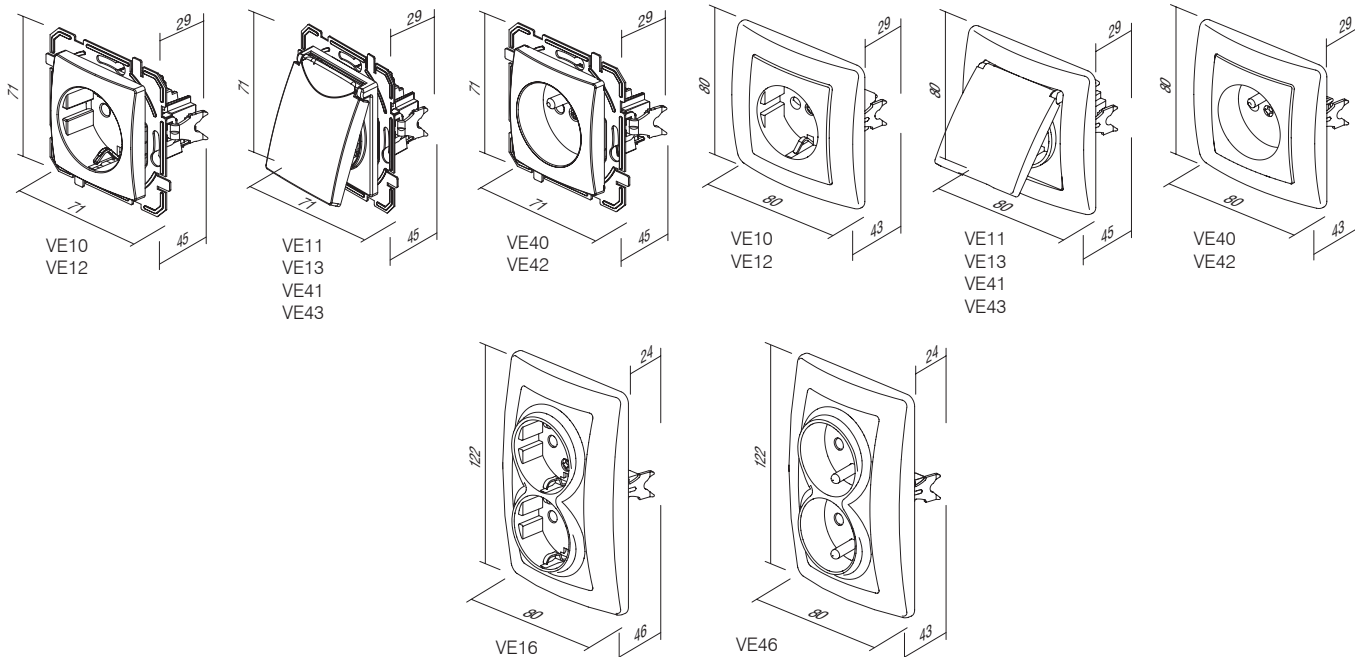

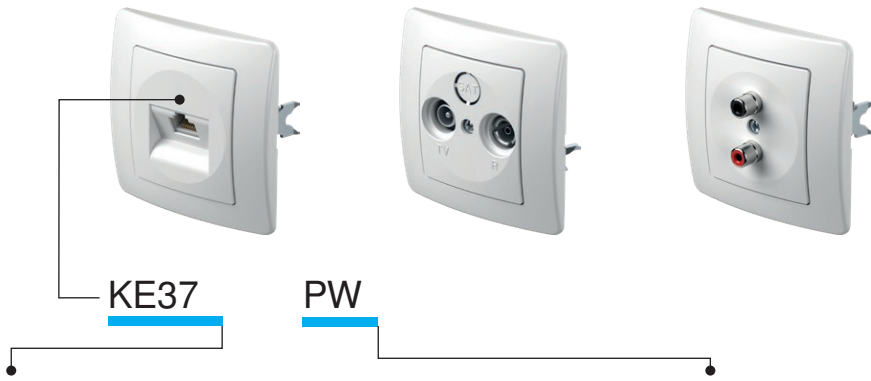

тип type	описание description	технически данни technical data	цвет colour
KE11	КОНЕКТОР ЗА ТВ-РАДИО КРАЕН SOCKET TV-R END-LINE	1dB	<input type="checkbox"/> PW снежнобял цвят polar white
KE12	КОНЕКТОР ЗА ТВ-РАДИО ПРЕХОДЕН SOCKET TV-R THROUGHPASS	10dB	<input type="checkbox"/> IW слонова кост ivory white
KE16	КОНЕКТОР ЗА СATEЛИТНА ТВ-РАДИО КРАЕН SOCKET SAT-TV-R END-LINE	3dB	<input type="checkbox"/> ES сребрист цвят с анодизирано покритие elox silver
...	<input type="checkbox"/> CO бял с термореактивен материал white thermoset
...	<input type="checkbox"/> NB тъмночерен night black

КОНЕКТОР ЗА ТВ-РАДИО КРАЕН 1 dB

KE11

- за ТВ-радио краен
- честотен обхват 5÷862 MHz
- затихване: Радио-1,5 dB, ТВ-1 dB
- в съответствие с EN 50083-1
- винтови контакти

SOCKET TV-R END-LINE 1dB

- TV-R end-line
- frequency range 5÷862MHz
- reduction: R-1,5dB, TV-1dB
- in accordance with EN 50083-1
- screw contacts

КОНЕКТОР ЗА ТВ-РАДИО ПРЕХОДЕН 10 dB

KE12

- преходник за ТВ-радио
- честотен обхват 5÷862 MHz
- затихване: Радио-10 dB, ТВ-10 dB, преход-2 dB
- в съответствие с EN 50083-1
- винтови контакти

SOCKET TV-R TROUGHPASS 10dB

- TV-R troughpass
- frequency range 5÷862MHz
- reduction: R-10dB, TV-10dB, trough-2dB
- in accordance with EN 50083-1
- screw contacts

КОНЕКТОР ЗА СATEЛИТНА ТВ-ТВ-РАДИО КРАЕН 3 dB

KE16

- за сателитна ТВ-ТВ-радио краен
- честотен обхват 5÷2400 MHz
- затихване: Радио-1dB, ТВ-1,5dB, сателитна ТВ-3 dB
- за монтаж в кръгла конзола Ø60 с крачета или винтове
- в съответствие с EN 50083-1
- винтови контакти

SOCKET SAT-TV-R END-LINE 3dB

- SAT-TV-R end-line
- frequency range 5÷2400MHz
- reduction: R-1dB, TV-1.5dB, SAT-3dB
- for mounting in round box Ø60 with claws or screws
- in accordance with EN 50083-1
- screw contacts

КОНЕКТОР ЗА ТЕЛЕФОН KS RJ11 6/4

KE36

- KS модул стандарт за закрепване
- RJ11 6/4
- в съответствие с IEC 60603-7

SOCKET TEL KS RJ11 6/4

- KS keystone fixing standard
- RJ11 6/4
- in accordance with IEC 60603-7

КОНЕКТОР CAT5e KS RJ45 8/8

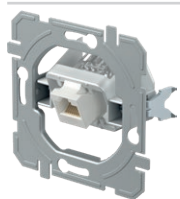

KE37

- KS модулен стандарт за закрепване
- CAT5e, RJ45 8/8
- в съответствие с IEC 60603-7

SOCKET CAT5e KS RJ45 8/8
 - KS keystone fixing standard
 - CAT5e, RJ45 8/8
 - in accordance with IEC 60603-7

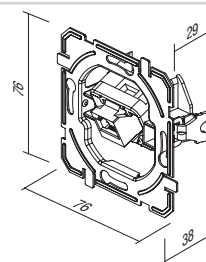

КОНЕКТОР CAT6s KS RJ45 8/8 SLIM

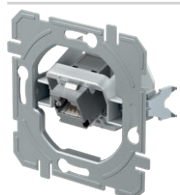

KE40

- KS модулен стандарт за закрепване
- CAT6s, RJ45 8/8
- в съответствие с IEC 60603-7

SOCKET CAT6s KS RJ45 8/8 SLIM
 - KS keystone fixing standard
 - CAT6s, RJ45 8/8
 - in accordance with IEC 60603-7

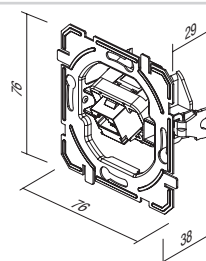

КОНЕКТОР ЗА ТЕЛЕФОН KS 2x RJ11 6/4

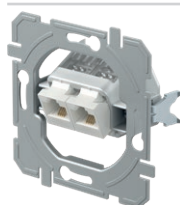

KE38

- KS модулен стандарт за закрепване
- 2 x RJ11 6/4
- в съответствие с IEC 60603-7

SOCKET TEL KS DOUBLE 2x RJ11 6/4
 - KS keystone fixing standard
 - 2x RJ11 6/4
 - in accordance with IEC 60603-7

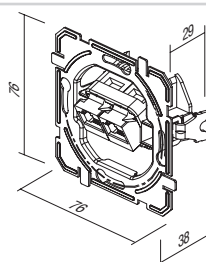

ДВОЕН КОНЕКТОР CAT5e KS 2x RJ45 8/8

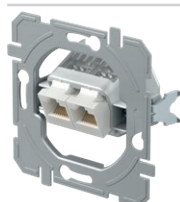

KE39

- KS модулен стандарт за закрепване
- 2 x CAT5e, RJ45 8/8
- в съответствие с IEC 60603-7

SOCKET CAT5e KS DOUBLE 2x RJ45 8/8
 - KS keystone fixing standard
 - 2x CAT5e, RJ45 8/8
 - in accordance with IEC 60603-7

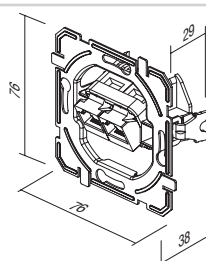

ДВОЕН КОНЕКТОР CAT6s KS 2x RJ45 8/8 SLIM

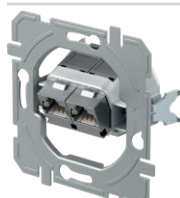

KE41

- KS модулен стандарт за закрепване
- 2 x CAT6s, RJ45 8/8
- в съответствие с IEC 60603-7

SOCKET CAT6s KS DOUBLE 2x RJ45 8/8 SLIM
 - KS keystone fixing standard
 - 2x CAT6s, RJ45 8/8
 - in accordance with IEC 60603-7

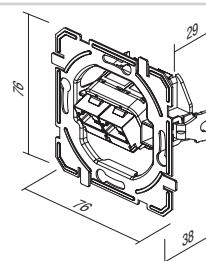

АДАПТЕР KS ЕДИНИЧЕН

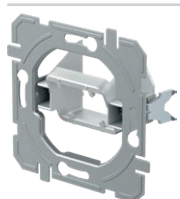

KE45

- KS модулен стандарт за закрепване – единичен
- AMP, Avaya, Brandrex, FMT, Mfico, Tyco, ...
- комуникационният модул не е включен в доставката

ADAPTER KS SINGLE
 - KS keystone fixing standard - single
 - AMP, Avaya, Brandrex, FMT, Mfico, Tyco, ...
 - communication module not included

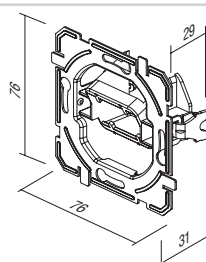

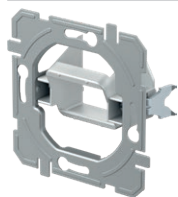

KE46

АДАПТЕР KS ДВОЕН

- KS модулен стандарт за закрепване – двоен
- AMP, Tyco, ...
- комуникационният модул не е включен в доставката

ADAPTER KS DOUBLE

- KS keystone fixing standard - double
- AMP, Tyco, ...
- communication module not included

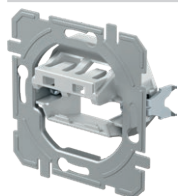
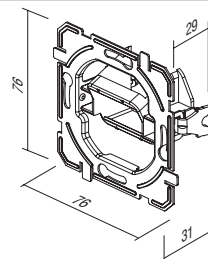

KE47

АДАПТЕР PD ДВОЕН

- стандарт за закрепване PD Panduit Mini-COM – двоен
- комуникационният модул не е включен в доставката

ADAPTER PD DOUBLE

- PD Panduit Mini-COM fixing standard - double
- communication module not included

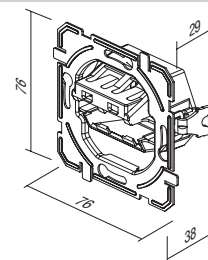

КОНЕКТОР ЗА ТВ ОСНОВЕН 0 dB



- KE10PW
- KE10IW
- KE10ES
- KE10CO
- KE10NB

- контакт за ТВ базов
- затихване 0 dB
- заден конектор – стандарт F

SOCKET TV BASIC 0dB

- TV basic
- reduction 0dB
- back connector – F standard



КОНЕКТОР ЗА ТВ-РАДИО КРАЕН 1 dB



- KE11PW
- KE11IW
- KE11ES
- KE11CO
- KE11NB

- за ТВ-радио краен
- честотен обхват 5÷862 MHz
- затихване: Радио-1.5 dB, ТВ-1 dB
- в съответствие с EN 50083-1
- винтови контакти

SOCKET TV-R END-LINE 1dB

- TV-R end-line
- frequency range 5÷862 MHz
- reduction: R-1.5dB, TV-1dB
- in accordance with EN 50083-1
- screw contact



КОНЕКТОР ЗА ТВ-РАДИО ПРЕХОДЕН 10 dB



- KE12PW
- KE12IW
- KE12ES
- KE12CO
- KE12NB

- преходник за ТВ-радио
- честотен обхват 5÷862 MHz
- затихване: Радио-10 dB, ТВ-10 dB, преход-2 dB
- в съответствие с EN 50083-1
- винтови контакти

SOCKET TV-R TROUGH-PASS 10dB

- TV-R troughpass
- frequency range 5÷862 MHz
- reduction: R-10dB, TV-10dB, trough-2dB
- in accordance with EN 50083-1
- screw contacts



КОНЕКТОР ЗА САТЕЛИТНА ТВ-ТВ-РАДИО КРАЕН 3 dB



- KE16PW
- KE16IW
- KE16ES
- KE16CO
- KE16NB

- за сателитна ТВ-ТВ-радио краен
- честотен обхват 5÷2400 MHz
- затихване: Радио-1dB, ТВ-1.5dB, сателитна ТВ-3 dB
- в съответствие с EN 50083-1
- винтови контакти

SOCKET SAT-TV-R END-LINE 3dB

- SAT-TV-R end-line
- frequency range 5÷2400 MHz
- reduction: R-1dB, TV-1.5dB, SAT-3dB
- in accordance with EN 50083-1
- screw contacts



КОНЕКТОР ЗА АУДИОСИГНАЛИ 2xRCA



- KE22PW
- KE22IW
- KE22ES
- KE22CO
- KE22NB

- за аудиосигнали, 2xRCA
- свързване на кабела чрез запояване

SOCKET AUDIO 2xRCA

- audio 2xRCA
- soldering connection of cable



КОНЕКТОР ЗА ВИСОКОГОВОРТЕЛИ



- KE23PW
- KE23IW
- KE23ES
- KE23CO
- KE23NB

- за аудиосигнали, 2x Ø4 mm
- за проводник за високоговорители, с щепсел тип банан Ø4 mm или плоски конектори
- свързване на кабела от задната страна чрез запояване

SOCKET AUDIO LOUDSPEAKERS

- audio 2x Ø4mm
- to accommodate speaker wire, banana plug Ø4mm or spades
- soldering connection of cable at the back side



КОНЕКТОР ЗА ТЕЛЕФОН KS RJ11 6/4

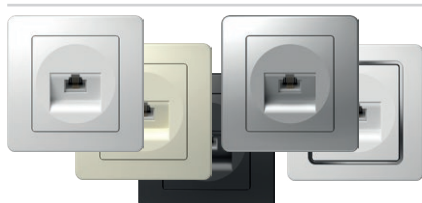

- KE36PW
- KE36IW
- KE36ES
- KE36CO
- KE36NB

- KS модул стандарт за закрепване
- RJ11 6/4
- в съответствие с IEC 60603-7

SOCKET TEL KS RJ11 6/4

- KS keystone fixing standard
- RJ11 6/4
- in accordance with IEC 60603-7





- KE37PW
- KE37IW
- KE37ES
- KE37CO
- KE37NB

КОНЕКТОР CAT5e KS RJ45 8/8

- KS модулен стандарт за закрепване
- CAT5e, RJ45 8/8
- в съответствие с IEC 60603-7

SOCKET CAT5e KS RJ45 8/8

- KS keystone fixing standard
- CAT5e, RJ45 8/8
- in accordance with IEC 60603-7

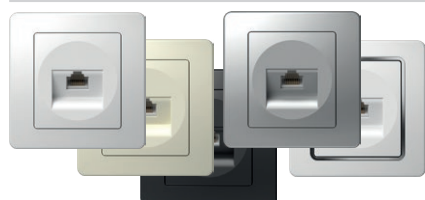

- KE40PW
- KE40IW
- KE40ES
- KE40CO
- KE40NB

КОНЕКТОР CAT6s KS RJ45 8/8 SLIM

- KS модулен стандарт за закрепване
- CAT6s, RJ45 8/8
- в съответствие с IEC 60603-7

SOCKET CAT6s KS RJ45 8/8 SLIM

- KS keystone fixing standard
- CAT6s, RJ45 8/8
- in accordance with IEC 60603-7

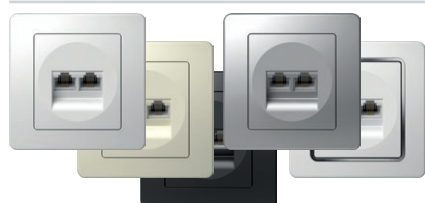

- KE38PW
- KE38IW
- KE38ES
- KE38CO
- KE38NB

КОНЕКТОР ЗА ТЕЛЕФОН KS 2x RJ11 6/4

- KS модулен стандарт за закрепване
- 2x RJ11, 6/4
- в съответствие с IEC 60603-7

SOCKET TEL KS DOUBLE 2x RJ11 6/4

- KS keystone fixing standard
- 2x RJ11, 6/4
- in accordance with IEC 60603-7



- KE39PW
- KE39IW
- KE39ES
- KE39CO
- KE39NB

ДВОЕН КОНЕКТОР CAT5e KS 2x RJ45 8/8

- KS модулен стандарт за закрепване
- 2 x CAT5e, RJ45 8/8
- в съответствие с IEC 60603-7

SOCKET CAT5e KS DOUBLE 2x RJ45 8/8

- KS keystone fixing standard
- 2x CAT5e, RJ45 8/8
- in accordance with IEC 60603-7



- KE41PW
- KE41IW
- KE41ES
- KE41CO
- KE41NB

ДВОЕН КОНЕКТОР CAT6s KS 2x RJ45 8/8 SLIM

- KS модулен стандарт за закрепване
- 2 x CAT6s, RJ45 8/8
- в съответствие с IEC 60603-7

SOCKET CAT6s KS DOUBLE 2x RJ45 8/8 SLIM

- KS keystone fixing standard
- 2x CAT6s, RJ45 8/8
- in accordance with IEC 60603-7



- KE35PW
- KE35IW
- KE35ES
- KE35CO
- KE35NB

КОНЕКТОР TEL LT RJ11 6/4

- телефонен LT винтов
- винтови контакти
- RJ11 6/4
- в съответствие с IEC 60603-7

SOCKET TEL LT RJ11 6/4

- TEL LT screw
- screw contacts
- RJ11 6/4
- in accordance with IEC 60603-7

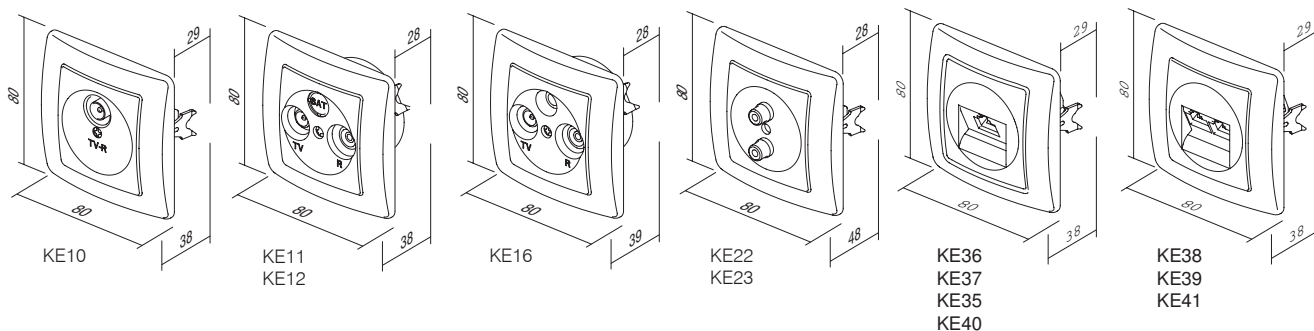

П А Н Е Л И З А К О М У Н И К А Ц И И К Е



PE20

PW

тип type	описание description	технически данни technical data	ЦВЯТ colour
PE10	ПАНЕЛ ЗА ТВ-РАДИО COVER TV-R	2P/3P	<input type="checkbox"/> PW снежнобял цвят polar white
PE20	ПАНЕЛ KS ЕДИНИЧЕН COVER KS SINGLE		<input type="checkbox"/> IW слонова кост ivory white
PE21	ПАНЕЛ KS ДВОЕН COVER KS DOUBLE		<input type="checkbox"/> ES сребрист цвят с анодизирано покритие elox silver
⋮	⋮	⋮	<input type="checkbox"/> CO бял с термореактивен материал white thermoset
			<input type="checkbox"/> NB тъмночерен night black

ПАНЕЛ ЗА ТВ-РАДИО 2P/3P



- PE10PW
- PE10IW
- PE10ES
- PE10CO
- PE10NB

- панел за ТВ-радио, 2P или 3P с винт

COVER TV-R 2P/3P

- TV-R cover, 2P or 3P with screw



ПАНЕЛ KS ЕДИНИЧЕН



- PE20PW
- PE20IW
- PE20ES
- PE20CO
- PE20NB

- панел KS единичен

COVER KS SINGLE

- KS cover single



ПАНЕЛ KS ДВОЕН

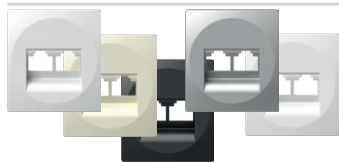

- PE21PW
- PE21IW
- PE21ES
- PE21NB

- панел KS двоен

COVER KS DOUBLE

- KS cover double



ПАНЕЛ TAE/TDO



- PE30PW
- PE30IW
- PE30ES
- PE30NB

- панел TAE или TDO с винт

COVER TAE/TDO

- TAE or TDO cover with screw

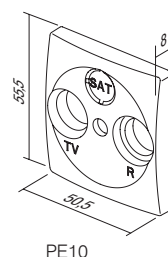
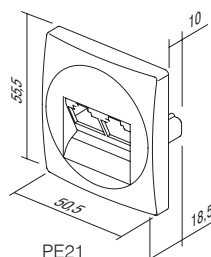
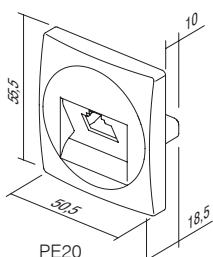
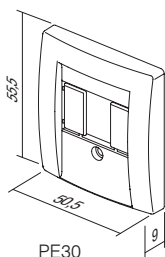



EE15

PW

тип type	описание description	технически данни technical data	цвет colour
EE15	DIMMER ROTATIVE 2WAY DIMMER ROTATIVE 2WAY	RL 400W	<input type="checkbox"/> PW снежнобял цвят polar white
EE16	DIMMER ROTATIVE 2WAY DIMMER ROTATIVE 2WAY	RLC 400W	<input type="checkbox"/> IW слонова кост ivory white
EE19	DIMMER ROTATIVE 2WAY DIMMER ROTATIVE 2WAY	LED 100W	<input type="checkbox"/> ES сребрист цвят с анодизирано покритие elox silver
⋮	⋮	⋮	<input type="checkbox"/> CO бял с термореактивен материал white thermoset
⋮	⋮	⋮	<input type="checkbox"/> NB тъмночерен night black

ДИМЕР, ВЪРТЯЩ ТИП/ДВУПОСОЧЕН, АКТИВЕН/ИНДУКТИВЕН ТОВАР 400 W



EE15

- управление чрез завъртане, с двупосочен ключ
- активен/индуктивен товар, 40 W – 400 W
- възможна е комбинация с двупосочен ключ
- не се допуска комбинация с допълнителни димери
- в съответствие с EN 60669-1 и EN 60669-2-1
- контакти чрез вкарване на проводниците 1,5 mm²
- захранващо напрежение 230 V~ 50 Hz
- вътрешен диаметър на бутона Ø6 mm
- предпазител за смяна е включен в доставката

DIMMER ROTATIVE 2WAY RL 400W

- rotation control with 2-way switch
- load RL, 40W - 400W
- 2-way switch combination is possible
- more dimmers combination is not allowed
- in accordance with EN 60669-1 and EN 60669-2-1
- plug-in contacts 1.5mm²
- supply 230V~ 50Hz
- button inner diameter Ø6mm
- replaceable fuse included

ДИМЕР, ВЪРТЯЩ ТИП/ДВУПОСОЧЕН, АКТИВЕН/ИНДУКТИВЕН/КАПАЦИТИВЕН ТОВАР 400 W

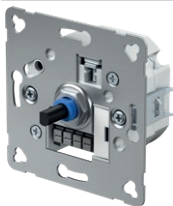

EE16

- управление чрез завъртане, с двупосочен ключ
- активен/индуктивен/капацитивен товар, 20 W – 400 W
- възможна е комбинация с двупосочен ключ
- не се допуска комбинация с допълнителни димери
- в съответствие с EN 60669-1 и EN 60669-2-1
- контакти чрез вкарване на проводниците 1,5 mm²
- захранващо напрежение 230 V~ 50 Hz
- вътрешен диаметър на бутона Ø6 mm
- електронен предпазител

DIMMER ROTATIVE 2WAY RLC 400W

- rotation control with 2-way switch
- load RLC, 20W - 400W
- 2-way switch combination is possible
- more dimmers combination is not allowed
- in accordance with EN 60669-1 and EN 60669-2-1
- plug-in contacts 1.5mm²
- supply 230V~ 50Hz
- button inner diameter Ø6mm
- electronic fuse

ДИМЕР, ВЪРТЯЩ ТИП/ДВУПОСОЧЕН, ЗА СВЕТОДИОДНО ОСВЕТЛЕНИЕ 100 W

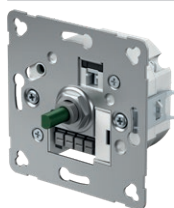

EE19



- управление чрез завъртане, с двупосочен ключ
- товар: светодиодно осветление, 0 - 100 W (max. 10 светодиода)
GLS, 10-250 W
- възможна е комбинация с двупосочен ключ
- не се допуска комбинация с допълнителни димери
- в съответствие с EN 60669-1 и EN 60669-2-1
- контакти чрез вкарване на проводниците 1,5 mm²
- захранващо напрежение 230 V~ 50 Hz
- предпазител за смяна е включен в доставката
- вътрешен диаметър на бутона Ø6 mm

DIMMER ROTATIVE 2WAY LED 100W

- rotation control with 2-way switch
- load: LED, 0-100W (max. 10 LEDs)
GLS, 10-250W
- 2-way switch combination is possible
- more dimmers combination is not allowed
- in accordance with EN 60669-1 and EN 60669-2-1
- plug-in contacts 1.5mm²
- supply 230V~ 50Hz
- replaceable fuse included
- button inner diameter Ø6mm

IR КЛЮЧ 5 A 250 V~

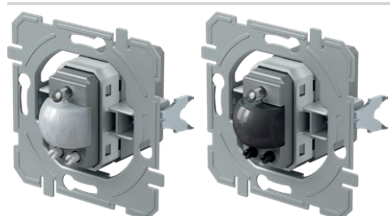

- EE32A1
- EE32A2



- инфрачервен ключ IR
- захранване: 230 V~ ±10 % 50 Hz
- реле: 5 A/250 V~ (нулевата стойност)
- клас на защита: IP40
- сечение на проводниците при контакта 0,75 - 2,5 mm²
- ъгъл на откриване: до 110° при 20° C
- разстояние на откриване: прил. 8 m при 20° C
- регулируема продължителност: от прил. 5 сек до 12 мин
- регулиране на яркостта на осветлението: от прил. 5 до 200 лукса
- работна температура: от 0° C до +40° C
- не е подходящо за инсталиране в конзоли с дълбочина 45 mm
- само за използване на закрито

IR SWITCH 5A 230V~

- IR infrared switch
- supply voltage: 230V~ ±10 % 50Hz
- relay: 5A / 250V~ (zero crossing)
- protection rating: IP40
- cross-section of wires at the contact terminal: 0.75 - 2.5 mm²
- detection angle: up to 110° at 20°C
- detection area: approx. 8 m at 20°C
- adjustability of duration: from approx. 5 s to 12 min
- adjustability of brightness: from approx. 5 to 200 LUX
- operating temperature: from 0°C to +40°C
- not suitable for installation in 45 mm deep boxes
- only for indoor usage



- EE15PW
- EE15IW
- EE15ES
- EE15CO
- EE15NB



ДИМЕР, ВЪРТЯЩ ТИП/ДВУПОСОЧЕН, АКТИВЕН/ИНДУКТИВЕН ТОВАР 400 W

- управление чрез завъртане, с двупосочен ключ
- активен/индуктивен товар, 40 W – 400 W
- възможна е комбинация с двупосочен ключ
- не се допуска комбинация с допълнителни димери
- в съответствие с EN 60669-1 и EN 60669-2-1
- контакти чрез вкарване на проводниците 1,5 mm²
- захранващо напрежение 230 V~ 50 Hz
- предпазител за смяна е включен в доставката



DIMMER ROTATIVE 2WAY RL 400W

- rotation control with 2-way switch
- load RL, 40W - 400W
- 2-way switch combination is possible
- more dimmers combination is not allowed
- in accordance with EN 60669-1 and EN 60669-2-1
- plug-in contacts 1.5mm²
- supply 230V~ 50Hz
- replaceable fuse included



- EE16PW
- EE16IW
- EE16ES
- EE16CO
- EE16NB



ДИМЕР, ВЪРТЯЩ ТИП/ДВУПОСОЧЕН, АКТИВЕН/ИНДУКТИВЕН/КАПАЦИТИВЕН ТОВАР 400 W

- управление чрез завъртане, с двупосочен ключ
- активен/индуктивен/капацитивен товар, 20 W – 400 W
- възможна е комбинация с двупосочен ключ
- не се допуска комбинация с допълнителни димери
- в съответствие с EN 60669-1 и EN 60669-2-1
- контакти чрез вкарване на проводниците 1,5 mm²
- захранващо напрежение 230 V~ 50 Hz
- електронен предпазител



DIMMER ROTATIVE 2WAY RLC 400W

- rotation control with 2-way switch
- load RLC, 20W - 400W
- 2-way switch combination is possible
- more dimmers combination is not allowed
- in accordance with EN 60669-1 and EN 60669-2-1
- plug-in contacts 1.5mm²
- supply 230V~ 50Hz
- electronic fuse



- EE19PW
- EE19IW
- EE19ES
- EE19CO
- EE19NB



ДИМЕР, ВЪРТЯЩ ТИП/ДВУПОСОЧЕН, ЗА СВЕТОДИОДНО ОСВЕТЛЕНИЕ 100 W

- управление чрез завъртане, с двупосочен ключ
- товар: светодиодно осветление, 0 - 100 W (max. 10 светодиода)
GLS, 10-250 W
- възможна е комбинация с двупосочен ключ
- не се допуска комбинация с допълнителни димери
- в съответствие с EN 60669-1 и EN 60669-2-1
- контакти чрез вкарване на проводниците 1,5 mm²
- захранващо напрежение 230 V~ 50 Hz
- предпазител за смяна е включен в доставката



DIMMER ROTATIVE 2WAY LED 100W

- rotation control with 2-way switch
- load: LED, 0-100W (max. 10 LEDs)
GLS, 10-250W
- 2-way switch combination is possible
- more dimmers combination is not allowed
- in accordance with EN 60669-1 and EN 60669-2-1
- plug-in contacts 1.5mm²
- supply 230V~ 50Hz
- replaceable fuse included



- EE32PW
- EE32IW
- EE32ES
- EE32CO
- EE32NB



IR КЛЮЧ 5 A 230V~

- инфрачервен ключ IR
- захранване: 230 V~ ±10 % 50 Hz
- реле: 5 A/250 V~ (нулевата стойност)
- клас на защита: IP40
- сечение на проводниците при контакта 0,75 - 2,5 mm²
- ъгъл на откриване: до 110° при 20° C
- разстояние на откриване: прил. 8 m при 20° C
- регулируема продължителност: от прил. 5 сек до 12 мин
- регулиране на яркостта на осветлението: от прил. 5 до 200 лукса
- работна температура: от 0° C до +40° C
- не е подходящо за инсталиране в конзоли с дълбочина 45 mm
- само за използване на закрито



IR SWITCH 5A 230V~

- IR infrared switch
- supply voltage: 230V~ ±10 % 50Hz
- relay: 5A / 250V~ (zero crossing)
- protection rating: IP40
- cross-section of wires at the contact terminal: 0.75 - 2.5 mm²
- detection angle: up to 110° at 20°C
- detection area: approx. 8 m at 20°C
- adjustability of duration: from approx. 5 s to 12 min
- adjustability of brightness: from approx. 5 to 200 LUX
- operating temperature: from 0°C to +40°C
- not suitable for installation in 45 mm deep boxes
- only for indoor usage



- EE69PW
- EE69IW
- EE69NB
- EE69ES

ЗАРЯДНО УСТРОЙСТВО USB PD 20W

- USB драйвър с осигуряване на мощност до 20W.
 - за зареждане на електронни устройства чрез стандартен USB порт (съвместимо и с устройствата Apple).

- захранване: 100-230 V~ 50/60 Hz
 - потребление в режим на функциониране 420 mA при 100 V~/220 mA при 230 V~
 - потребление в изключен режим: <100 mW при 230 V~
 - изходна мощност: Макс 20W.

Изход/ порт:

- USB тип C 5.0 VDC 3.0A; 9.0 VDC 2.2 A
 12.0 VDC 1.67 A (PD 20W)

- USB тип A 5.0 VDC 3.0A; 9.0 VDC 2.0 A
 12.0 VDC 1.5 A (QC 18W)

- USB A+C: 5 VDC 3A

- тип конектор: 1 x USB A; 1 x USB C

- средна ефективност в активен режим: 86%

- ефективност при минимално натоварване (10%): 81%

- температура при функциониране 0 °C/+ 45 °C (вътрешно ползване)

- клас IP защита: IP20, само за вътрешно ползване.

- клас на безопасност на устройството II

- защита от пренапрежение (EN 60364-4-44): клас III

- прикрепване на проводниците с винтове макс. 2.5 кв. мм

- устройство с отстояние на контактите мин. 3 мм

- не е подходящо за вграждането в конзоли с дълбочина 45 мм и конзоли за

външен монтаж CUBO IP20.

Съответства на:

Директиви: BT, EMC, RoHS, ErP

Стандарти: EN IEC 62368-1, EN 55032, EN55035, EN IEC 61000-3-2, EN 61000-3-3, EN 50563, EN IEC 63000

Допълнителни регулации: (EU) n. 2019/1782 REACh, n. 1907/2006 – чл. 33.

Изделието може да съдържа следи от олово.



USB POWER SUPPLY UNIT PD 20W

- 20 W USB power delivery power supply unit

- for charging of electronic devices via a standard USB port (also compatible with Apple devices)

- power supply: 100-230V~ 50/60Hz

- power consumption: 420mA at 100V~/220mA at 230V~

- standby power consumption: <100mW at 230V~

- Output power: 20 W Max

- Output:

- USB tip C: 5.0 VDC 3.0A; 9.0 VDC 2.2 A; 12.0 VDC 1.67 A (PD 20W)

- USB tip A: 5.0 VDC 3.0A; 9.0 VDC 2.0 A; 12.0 VDC 1.5 A (QC 18W)

- USB A+C: 5 VDC 3A

- connector type: 1x USB A; 1x USB C

- average efficiency in active mode: 86%

- efficiency with low load (10%): 81%

- operating temperature: 0 °C/+45 °C (indoor use)

- IP protection class: IP20, indoor use only

- class device II

- overvoltage category (EN 60364-4-44): Class III

- screw contacts: max. 2.5 mm²

- device with a contact gap of at least 3mm

Conformity:

Directive: BT, EMC, RoHS, ErP

Standards: EN IEC 62368-1, EN 55032, EN55035, EN IEC 61000-3-2, EN 61000-3-3, EN 50563, EN IEC 63000

External power supplies regulation: (EU) n. 2019/1782 REACh, n. 1907/2006

- art.33.The product may contain traces of lead.

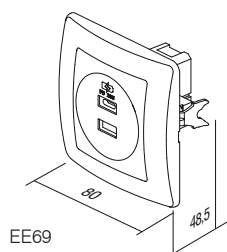

EE69

EE15, EE16, EE19

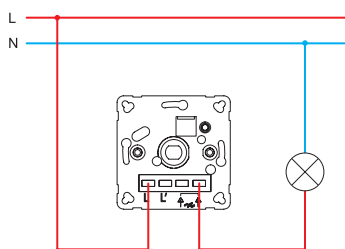

EE15, EE16, EE19

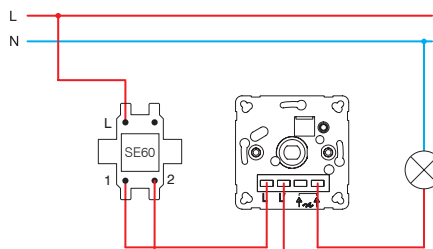

EE15, EE16, EE19

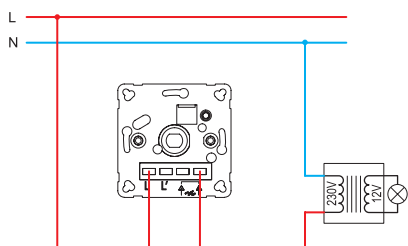

EE15, EE16, EE19

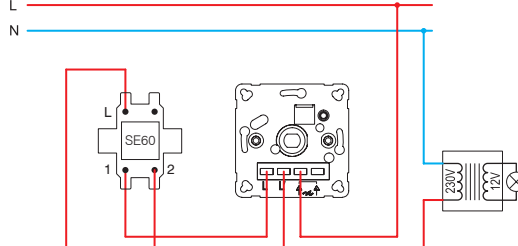

EE16, EE19

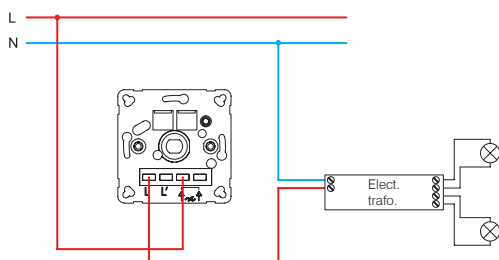

EE16, EE19

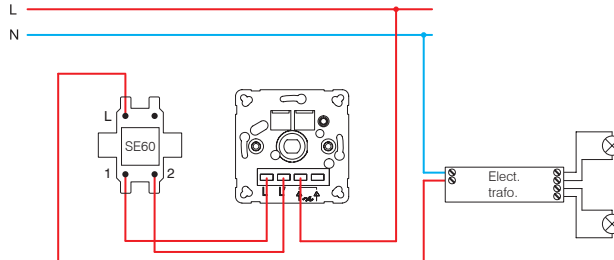

EE15 (40÷400W)

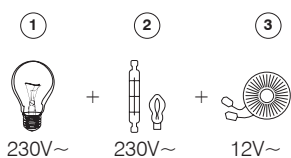

- 1 – лампа с нажежаема жичка /
incandescent lamp
 2 – халогенна лампа /
halogen lamp

EE16 (20÷400W)

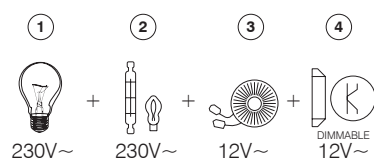

- 3 – класически трансформатор /
classical transformer
 4 – Димиращ електронен трансформатор /
dimmable electronic transformer

EE19 (GLS 10÷250W ; LED 0÷100W)

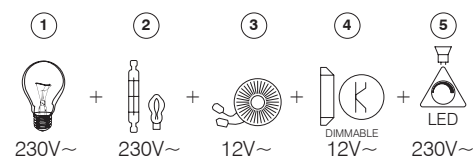

- 5 – димируема светодиодна лампа/
dimmable LED lamp

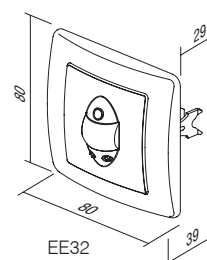
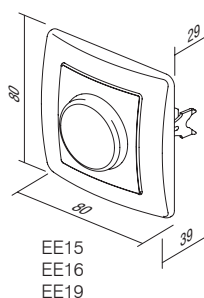
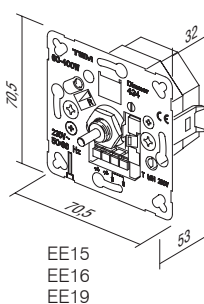

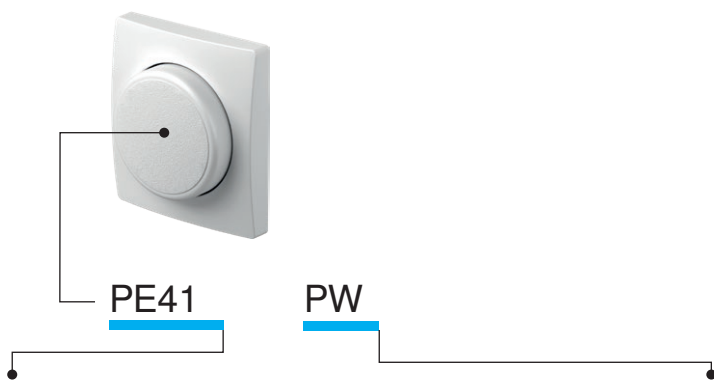

тип type	описание description	ЦВЯТ colour
PE41	ПАНЕЛ ЗА ДИМЕР COVER DIMMER	<input type="checkbox"/> PW снежнобял цвят <i>polar white</i> <input type="checkbox"/> IW слонова кост <i>ivory white</i> <input type="checkbox"/> ES сребрист цвят с анодизирано покритие <i>elox silver</i> <input type="checkbox"/> CO бял с термореактивен материал <i>white thermoset</i> <input type="checkbox"/> NB тъмночерен <i>night black</i>



- PE41PW
- PE41IW
- PE41NB
- PE41ES
- PE41CO

ПАНЕЛ ЗА ДИМЕР Ø6

- панел за димер Ø6 mm
- за EE15, EE16, EE19

COVER DIMMER Ø6
- cover dimmer Ø6mm
- for EE15, EE16, EE19



- PE32PW
- PE32IW
- PE32NB
- PE32ES

ПАНЕЛ IR КЛЮЧ

- панел за ИЧ ключ

COVER IR SWITCH
- cover IR switch

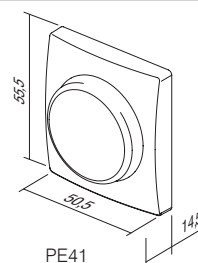
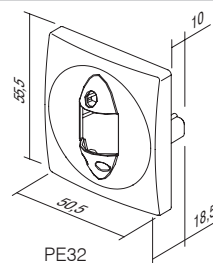

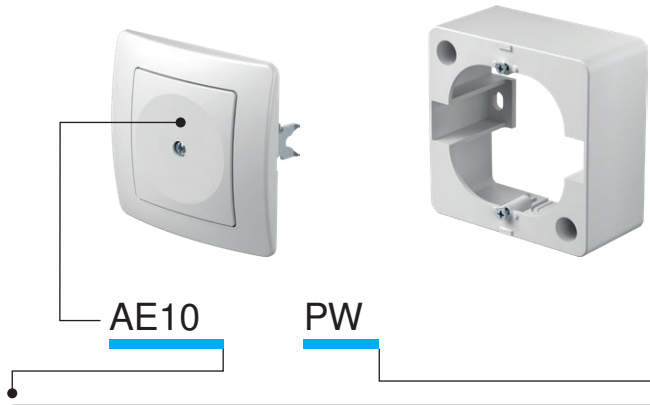

тип type	описание description	цвет colour
AE10	КАПАЧЕ BLANK	<input type="checkbox"/> PW снежнобял цвят polar white
AE20	СЪЕДИНИТЕЛНА КОНЗОЛА 5POLE 3P+N+E 5x4 mm ² CONNECTION BOX 3P+N+E 5X4mm ²	<input type="checkbox"/> IW слонова кост ivory white
AE30	КОНЗОЛА ЗА ВЪНШЕН МОНТАЖ 1 SURFACE MOUNT BOX	<input type="checkbox"/> ES сребрист цвят с анодизирано покритие elox silver
⋮	⋮	<input type="checkbox"/> CO бял с термореактивен материал white thermoset
⋮	⋮	<input type="checkbox"/> NB тъмночерен night black

КАПАЧЕ



- AE10PW
- AE10IW
- AE10NB
- AE10ES
- AE10CO

- за запълване на празни позиции

BLANK

- for filling up empty spaces



СЪЕДИНИТЕЛНА КОНЗОЛА 5POLE 3P+N+E 5x4 mm²



- AE20PW
- AE20IW

- съединителна конзола 3P +N+E
- 16 A 400 V~
- в съответствие с VDE 0606-1:2000
- винтови контакти 1,5 - 4 mm²

CONNECTION BOX 5POLE 3P+N+E 5x4mm²

- 3P+N+E connection box
- 16A 400V~
- in accordance with VDE 0606-1:2000
- screw contacts 1.5-4mm²



КОНЗОЛА ЗА ВЪНШЕН МОНТАЖ 1

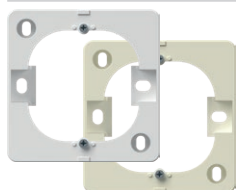

- AE30PW
- AE30IW

- конзола за външен монтаж

SURFACE MOUNT BOX 1

- surface mounting box



КУТИЯ ЗА МОНТАЖ НА ПОВЪРХНОСТИ ЗА ДВОЕН КОНТАКТ

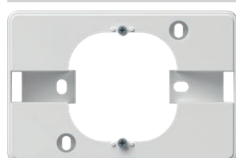

- AE31PW

- конзола за външен монтаж

SURFACE MOUNT BOX FOR DOUBLE SOCKET

- surface mounting box



СТЕННА ЗАЩИТА



- AE50PW
- AE50TS

- защитава повърхността около контакт или ключ

WALL PROTECTION

- protects surface around socket or switch

ЗАЩИТА ЗА ДЕЦА KS



- AE51PW
- AE51IW

- KS допълнителен елемент за защита за деца

CHILD PROTECTION KS

- KS additional child protection insert - shuttered live contacts

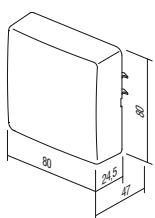

AE20

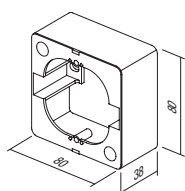

AE30

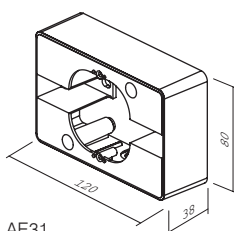

AE31

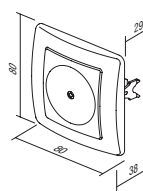

AE10

S U R R O U N D S O E

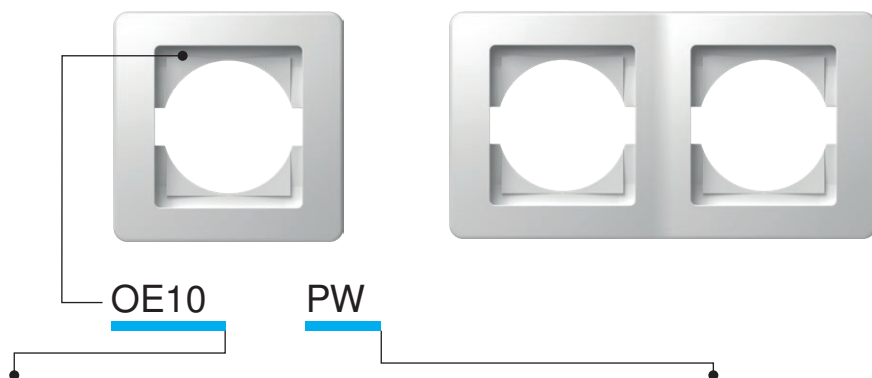

тип type	описание description	цвет colour
OE10	РАМКА ЕКОНОМИК 1 SURROUND EKONOMIK 1	<input type="checkbox"/> PW снежнобял цвят polar white
OE20	РАМКА ЕКОНОМИК 2 ХОРИЗОНТАЛНА SURROUND EKONOMIK 2 HORIZONTAL	<input type="checkbox"/> IW слонова кост ivory white
OE30	РАМКА ЕКОНОМИК 3 ХОРИЗОНТАЛНА SURROUND EKONOMIK 3 HORIZONTAL	<input type="checkbox"/> ES сребрист цвят с анодизирано покритие elox silver
⋮	⋮	<input type="checkbox"/> CO бял с термореактивен материал white thermoset
⋮	⋮	<input type="checkbox"/> NB тъмночерен night black

РАМКА ЕКОНОМИК 1



- OE10PW
- OE10IW
- OE10ES
- OE10CO
- OE10NB

- декоративна рамка единична
- в съответствие с EN 60669-1

SURROUND EKONOMIK 1
- decorative surround 1-gang
- in accordance with EN 60669-1

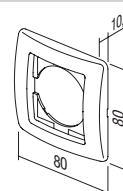

РАМКА ЕКОНОМИК 2 ХОРИЗОНТАЛНА



- OE20PW
- OE20IW
- OE20ES
- OE20CO
- OE20NB

- декоративна рамка двойна хоризонтална
- в съответствие с EN 60669-1

SURROUND EKONOMIK 2 HORIZONTAL
- decorative surround 2-gang horizontal
- in accordance with EN 60669-1

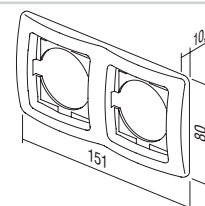

РАМКА ЕКОНОМИК 2 ВЕРТИКАЛНА



- OE21PW
- OE21IW
- OE21ES
- OE21CO
- OE21NB

- декоративна рамка двойна вертикална
- в съответствие с EN 60669-1

SURROUND EKONOMIK 2 VERTICAL
- decorative surround 2-gang vertical
- in accordance with EN 60669-1

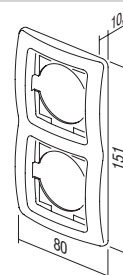

РАМКА ЕКОНОМИК 3 ХОРИЗОНТАЛНА



- OE30PW
- OE30IW
- OE30ES
- OE30CO
- OE30NB

- декоративна рамка тройна хоризонтална
- в съответствие с EN 60669-1

SURROUND EKONOMIK 3 HORIZONTAL
- decorative surround 3-gang horizontal
- in accordance with EN 60669-1

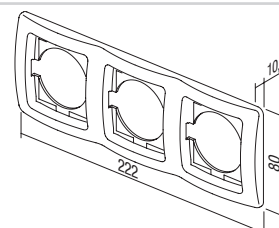

РАМКА ЕКОНОМИК 3 ВЕРТИКАЛНА



- OE31PW
- OE31IW
- OE31ES
- OE31CO
- OE31NB

- декоративна рамка тройна вертикална
- в съответствие с EN 60669-1

SURROUND EKONOMIK 3 VERTICAL
- decorative surround 3-gang vertical
- in accordance with EN 60669-1

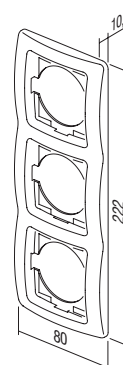

РАМКА ЕКОНОМИК 4 ХОРИЗОНТАЛНА



- OE40PW
- OE40IW
- OE40ES
- OE40NB

- декоративна рамка четворна хоризонтална
- в съответствие с EN 60669-1

SURROUND EKONOMIK 4 HORIZONTAL
- decorative surround 4-gang horizontal
- in accordance with EN 60669-1

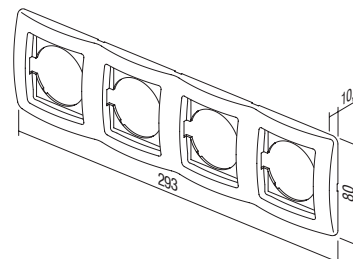

РАМКА ЕКОНОМИК 4 ВЕРТИКАЛНА



- OE41PW
- OE41IW
- OE41ES
- OE41NB

- декоративна рамка четворна вертикална
- в съответствие с EN 60669-1

SURROUND EKONOMIK 4 VERTICAL
- decorative surround 4-gang vertical
- in accordance with EN 60669-1

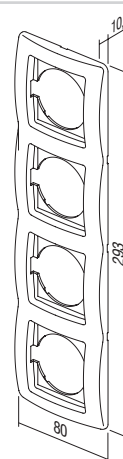

РАМКА ЕКОНОМИК 5 ХОРИЗОНТАЛНА



- OE50PW
- OE50IW
- OE50ES
- OE50NB

- декоративна рамка петорна хоризонтална
- в съответствие с EN 60669-1

SURROUND EKONOMIK 5 HORIZONTAL
- decorative surround 5-gang horizontal
- in accordance with EN 60669-1

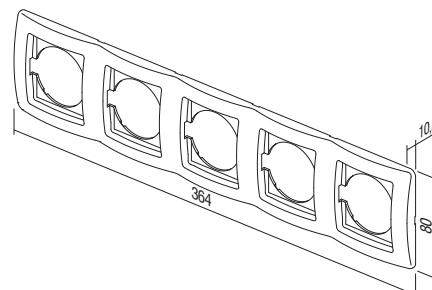

ЦВЕТНИ ДЕКОРАТИВНИ РАМКИ /
 COLOR DECORATIVE FRAMES



OE90GR	ЗЕЛЕНА / GREEN	OE90YL	ЖЪЛТА / YELLOW	OE90MB	МЕТ. СИНЯ / MET. BLUE
OE90BL	СИНЯ / BLUE	OE90WH	БЯЛА / WHITE	OE90BZ	БРОНЗ / BRONZE
OE90VO	ВИОЛЕТОВА / VIOLET	OE90GY	СИВА / GREY	OE90CR	СРЕБРИСТА / SILVER
OE90PI	РОЗОВА / PINK	OE90BK	ЧЕРНА / BLACK	OE90GO	ЗЛАТИСТА / GOLD
OE90RD	ЧЕРВЕНА / RED				





fontana



TEM



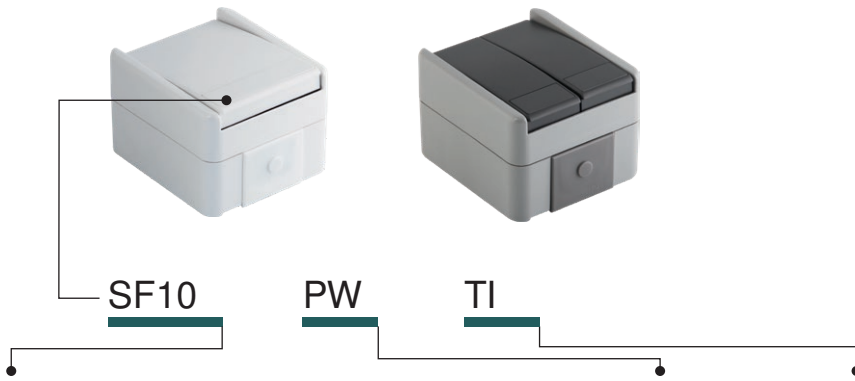

тип <i>type</i>	описание <i>description</i>	технически данни <i>technical data</i>	цвет <i>colour</i>	допълнителна информация 1 <i>optional data 1</i>
SF10	SWITCH 1WAY SWITCH 1WAY	IP44 10AX 250V~	<input type="checkbox"/> PW бял-матов white-mat	TI неоновая лампа+индикация neon lamp+indication
SF11	PUSH BUTTON 1WAY PUSH BUTTON 1WAY	IP44 10A 250V~	<input type="checkbox"/> GY сив-матов grey-mat	
SF20	SWITCH 2POLE SWITCH 2POLE	IP44 10AX 250V~		
:	:	:		
:	:	:		

КЛЮЧ 1WAY IP44 10AX 250V~



- SF10PW
- SF10GY

- 10AX 250V~, тип SF10
- в съответствие с EN 60669-1
- контакти чрез вкарване 1,5 - 2,5 mm²

SWITCH 1WAY IP44 10AX 250V~
- 10AX 250V~, type SF10
- in accordance with EN 60669-1
- plug-in contacts 1.5-2.5mm²



КЛЮЧ 1WAY IP44 10AX 250V~ __ TI



- SF10PWTI
- SF10GYTI

- TI индикатор+неонова лампа
- 10AX 250V~, тип SF10
- в съответствие с EN 60669-1
- контакти чрез вкарване 1,5 - 2,5 mm²

SWITCH 1WAY IP44 10AX 250V~ __ TI
- TI indicator+neon lamp
- 10AX 250V~, type SF10
- in accordance with EN 60669-1
- plug-in contacts 1.5-2.5mm²



БУТОН 1WAY IP44 10A 250V~ __ TI



- SF11PWTI
- SF11GYTI

- TI индикатор+неонова лампа
- 10A 250V~, тип SF11
- в съответствие с EN 60669-1
- контакти чрез вкарване 1,5 - 2,5 mm²

PUSH BUTTON 1WAY IP44 10A 250V~ __ TI
- TI indicator+neon lamp
- 10A 250V~, type SF11
- in accordance with EN 60669-1
- plug-in contacts 1.5-2.5mm²



КЛЮЧ 2POLE IP44 10AX 250V~



- SF20PW
- SF20GY

- 10AX 250V~, тип SF20
- в съответствие с EN 60669-1
- контакти чрез вкарване 1,5 - 2,5 mm²

SWITCH 2POLE IP44 10AX 250V~
- 10AX 250V~, type SF20
- in accordance with EN 60669-1
- plug-in contacts 1.5-2.5mm²



	<ul style="list-style-type: none"> <input type="checkbox"/> SF50PW <input type="checkbox"/> SF50GY 	<p>КЛЮЧ 2GANG-1WAY IP44 10AX 250V~</p> <ul style="list-style-type: none"> - 10AX 250V~, тип SF50 - в съответствие с EN 60669-1 - контакти чрез вкарване 1,5 - 2,5 mm² 	
	<ul style="list-style-type: none"> <input type="checkbox"/> SF51PW <input type="checkbox"/> SF51GY 	<p>БУТОН 2GANG-1WAY IP44 10A 250V~</p> <ul style="list-style-type: none"> - 10 A 250 V~, тип SF51 - в съответствие с EN 60669-1 - контакти чрез вкарване 1,5 - 2,5 mm² 	
	<ul style="list-style-type: none"> <input type="checkbox"/> SF60PW <input type="checkbox"/> SF60GY 	<p>КЛЮЧ 2WAY IP44 10AX 250V~</p> <ul style="list-style-type: none"> - 10AX 250V~, тип SF60 - в съответствие с EN 60669-1 - контакти чрез вкарване 1,5 - 2,5 mm² 	
	<ul style="list-style-type: none"> <input type="checkbox"/> SF60PWTI <input type="checkbox"/> SF60GYTI 	<p>КЛЮЧ 2WAY IP44 10AX 250V~ __ TI</p> <ul style="list-style-type: none"> - TI индикатор+неонова лампа - 10AX 250V~, тип SF60 - в съответствие с EN 60669-1 - контакти чрез вкарване 1,5 - 2,5 mm² 	
	<ul style="list-style-type: none"> <input type="checkbox"/> SF63PW <input type="checkbox"/> SF63GY 	<p>КЛЮЧ 2WAY DOUBLE IP44 10AX 250V~</p> <ul style="list-style-type: none"> - 10AX 250V~, тип SF63 - в съответствие с EN 60669-1 - контакти чрез вкарване 1,5 - 2,5 mm² 	
	<ul style="list-style-type: none"> <input type="checkbox"/> SF70PW <input type="checkbox"/> SF70GY 	<p>КРЪСТАТ КЛЮЧ IP44 10AX 250V~</p> <ul style="list-style-type: none"> - 10AX 250V~, тип SF70 - в съответствие с EN 60669-1 - контакти чрез вкарване 1,5 - 2,5 mm² 	

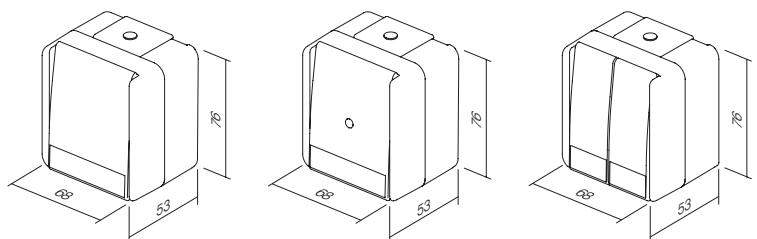

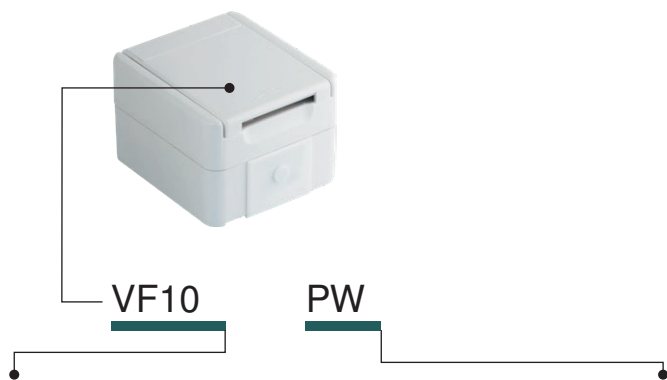

тип type	описание description	технически данни technical data	цвет colour
VF10	КОНТАКТ SCHUKO+КАПАК SOCKET SCHUKO+COVER	IP44 2P+E 16A 250V~	<input type="checkbox"/> PW бял-матов white-mat <input type="checkbox"/> GY сив-матов grey-mat



- VF10PW
- VF10GY

КОНТАКТ SCHUKO+КАПАК IP44 2P+E 16A 250V~

- винтови контакти 1,5 - 2,5 mm²
- 2P+E шуко+капак
- 16A 250 V~, тип VF10
- в съответствие с EN 60884-1, CEE7

SOCKET SCHUKO+COVER IP44 2P+E 16A 250V~

- screw contacts 1.5-2.5mm²
- 2P+E schuko+cover
- 16A 250V~, type VF10
- in accordance with EN 60884-1, CEE7



- VF12PW
- VF12GY

КОНТАКТ SCHUKO+КАПАК IP44 2P+E 16A 250V~ BV

- BV контакти чрез вкарване 1,5 - 2,5 mm²
- 2P+E шуко+капак
- 16A 250 V~, тип VF12
- в съответствие с EN 60884-1, CEE7

SOCKET SCHUKO+COVER IP44 2P+E 16A 250V~ BV

- BV plug-in contacts 1.5-2.5mm²
- 2P+E schuko+cover
- 16A 250V~, type VF12
- in accordance with EN 60884-1, CEE7

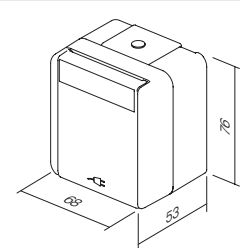

VF10
VF12

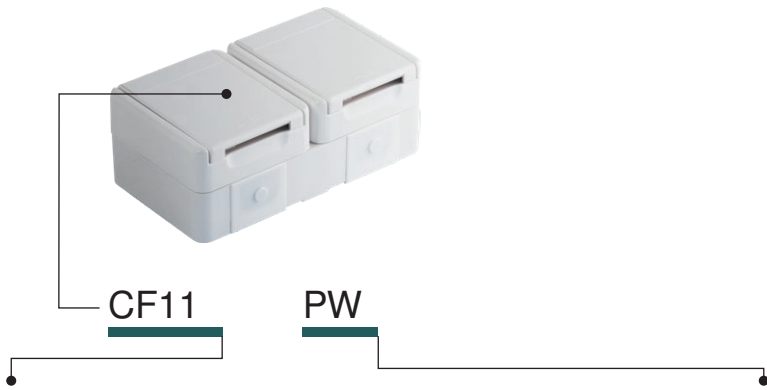

тип type	описание description	технически данни technical data	цвет colour
CF10	КОМПЛЕКТ КОНТАКТИ ШУКО ДВОЙНИ ХОРИЗОНТАЛНИ <i>SOCKET SET SCHUKO DOUBLE HORIZ</i>	2x 2P+E 16A 250V~ IP44	<input type="checkbox"/> PW бял-матов <i>white-mat</i>
CF11	КОМПЛЕКТ КОНТАКТИ ШУКО ДВОЙНИ ВЕРТИКАЛНИ <i>SOCKET SET SCHUKO DOUBLE VERT</i>	2x 2P+E 16A 250V~ IP44	<input checked="" type="checkbox"/> GY сив-матов <i>grey-mat</i>
CF12	КОМПЛЕКТ КОНТАКТИ ШУКО ДВОЙНИ ВЕРТИКАЛНИ <i>SOCKET SCH+SWITCH 2WAY HORIZ</i>	16A + 10A 250V~ IP44	
⋮	⋮	⋮	
⋮	⋮	⋮	



- CF10PW
 CF10GY

КОМПЛЕКТ КОНТАКТИ ШУКО ДВОЙНИ ХОРИЗОНТАЛНИ IP44 2x 2P+E 16A 250V~

- винтови контакти 1,5 - 2,5 mm²
- 2x 2P+E шуко+капак хоризонтални
- 16A 250 V~, тип CF10
- в съответствие с EN 60884-1, CEE7

SOCKET SET SCHUKO DOUBLE HORIZONTAL IP44 2x 2P+E 16A 250V~
- screw contacts 1.5-2.5mm²
- 2x 2P+E schuko+cover horizontal
- 16A 250V~, type CF10
- in accordance with EN 60884-1, CEE7



- CF11PW
 CF11GY

КОМПЛЕКТ КОНТАКТИ ШУКО ДВОЙНИ ВЕРТИКАЛНИ IP44 2x 2P+E 16A 250V~

- винтови контакти 1,5 - 2,5 mm²
- 2x 2P+E шуко+капак вертикални
- 16A 250 V~, тип CF11
- в съответствие с EN 60884-1, CEE7

SOCKET SET SCHUKO DOUBLE VERTICAL IP44 2x 2P+E 16A 250V~
- screw contacts 1.5-2.5mm²
- 2x 2P+E schuko+cover vertical
- 16A 250V~, type CF11
- in accordance with EN 60884-1, CEE7



- CF12PW
 CF12GY

КОМПЛЕКТ КОНТАКТ ШУКО+КЛЮЧ ХОРИЗОНТАЛНИ 2WAY IP44 16A + 10AX 250V~

- винтове (контакта), чрез вкарване на проводниците (ключа) контакти 1,5 - 2,5 mm²
- 2P+E шуко+капак + ключ 2-way хоризонтални
- 16 A + 10AX 250 V~, тип CF12
- в съответствие с EN 60884-1, CEE7, EN 60669-1

SOCKET SCH+SWITCH SET 2WAY HORIZONTAL IP44 16A + 10AX 250V~
- screw (socket), plug-in (switch) contacts 1.5-2.5mm²
- 2P+E schuko+cover + switch 2-way horizontal
- 16A + 10AX 250V~, type CF12
- in accordance with EN 60884-1, CEE7, EN 60669-1



КОМПЛЕКТ КОНТАКТ ШУКО+КЛЮЧ ВЕРТИКАЛНИ IP44 16A + 10AX 250V~



- CF13PW
- CF13GY

- винтове (контакта), чрез вкарване на проводниците (ключа)
- контакти чрез вкарване 1,5 - 2,5 mm²
- 2P+E шуко+капак + ключ 2-way вертикални
- 16 A + 10AX 250 V~, тип CF13
- в съответствие с EN 60884-1, CEE7, EN 60669-1

SOCKET SCH+SWITCH 2WAY SET VERTICAL IP44 16A + 10AX 250V~

- screw (socket), plug-in (switch) contacts 1.5-2.5mm²
- 2P+E schuko+cover + switch 2-way vertical
- 16A + 10AX 250V~, type CF13
- in accordance with EN 60884-1, CEE7, EN 60669-1



КОМПЛЕКТ КОНТАКТИ ШУКО ДВОЙНИ ХОРИЗОНТАЛНИ IP44 2x 2P+E 16A 250V~ BV



- CF14PW
- CF14GY

- BV контакти чрез вкарване 1,5 - 2,5 mm²
- 2x 2P+E шуко+капак хоризонтални
- 16A 250 V~, тип CF14
- в съответствие с EN 60884-1, CEE7

SOCKET SET SCHUKO DOUBLE HORIZONTAL IP44 2x 2P+E 16A 250V~ BV

- BV plug-in contacts 1.5-2.5mm²
- 2x 2P+E schuko+cover horizontal
- 16A 250V~, type CF14
- in accordance with EN 60884-1, CEE7



КОМПЛЕКТ КОНТАКТИ ШУКО ДВОЙНИ ВЕРТИКАЛНИ IP44 2x 2P+E 16A 250V~ BV



- CF15PW
- CF15GY

- BV контакти чрез вкарване 1,5 - 2,5 mm²
- 2x 2P+E шуко+капак вертикални
- 16A 250 V~, тип CF15
- в съответствие с EN 60884-1, CEE7

SOCKET SET SCHUKO DOUBLE VERTICAL IP44 2x 2P+E 16A 250V~ BV

- BV plug-in contacts 1.5-2.5mm²
- 2x 2P+E schuko+cover vertical
- 16A 250V~, type CF15
- in accordance with EN 60884-1, CEE7



КОМПЛЕКТ КОНТАКТ ШУКО+КЛЮЧ ХОРИЗОНТАЛНИ 2WAY IP44 16A + 10AX 250V~ BV



- CF16PW
- CF16GY

- BV контакти чрез вкарване 1,5 - 2,5 mm²
- 2P+E шуко+капак + ключ 2-way хоризонтални
- 16 A + 10AX 250 V~, тип CF16
- в съответствие с EN 60884-1, CEE7, EN 60669-1

SOCKET+SWITCH SET SCH+2WAY HORIZONTAL IP44 16A + 10AX 250V~ BV

- BV plug-in contacts 1.5-2.5mm²
- 2P+E schuko+cover + switch 2-way horizontal
- 16A + 10AX 250V~, type CF16
- in accordance with EN 60884-1, CEE7, EN 60669-1



КОМПЛЕКТ КОНТАКТ ШУКО+КЛЮЧ 2WAY ВЕРТИКАЛНИ IP44 16A + 10AX 250V~ BV



- CF17PW
- CF17GY

- BV контакти чрез вкарване 1,5 - 2,5 mm²
- 2P+E шуко+капак + ключ 2-way вертикални
- 16 A + 10AX 250 V~, тип CF17
- в съответствие с EN 60884-1, CEE7, EN 60669-1

SOCKET SCH+SWITCH 2WAY SET VERTICAL IP44 16A + 10AX 250V~ BV

- BV plug-in contacts 1.5-2.5mm²
- 2P+E schuko+cover + switch 2-way vertical
- 16A + 10AX 250V~, type CF17
- in accordance with EN 60884-1, CEE7, EN 60669-1



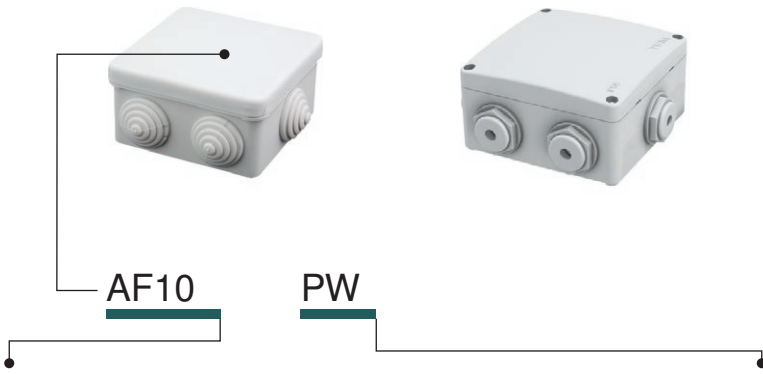

тип type	описание description	технически данни technical data	цвет colour
AF10	РАЗПРЕДЕЛИТЕЛНА КУТИЯ DISTRIBUTION BOX	IP44 RN01	<input type="checkbox"/> PW бял-матов white-mat
AF20	РАЗПРЕДЕЛИТЕЛНА КУТИЯ DISTRIBUTION BOX	IP55 ND01	<input type="checkbox"/> GY сив-матов grey-mat

РАЗПРЕДЕЛИТЕЛНА КУТИЯ IP44 RN01



- AF10PW
- AF10GY

- разпределителна кутия за външен монтаж IP44
- 16 A 400 V~
- в съответствие с IEC/EN 60670-1, IEC/EN 60670-22

DISTRIBUTION BOX IP44 RN01

- surface mounting distribution box IP44
- 16A 400V~
- in accordance with IEC/EN 60670-1, IEC/EN 60670-22

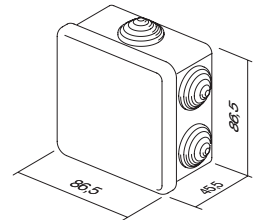

РАЗПРЕДЕЛИТЕЛНА КУТИЯ IP55 ND01



- AF20PW
- AF20GY

- съединителна кутия за външен монтаж IP55
- кабелните щучери са включени в доставката
- в съответствие с IEC/EN 60670-1, IEC/EN 60670-22

DISTRIBUTION BOX IP55 ND01

- surface mounting connection box IP55
- glands included
- in accordance with IEC/EN 60670-1, IEC/EN 60670-22

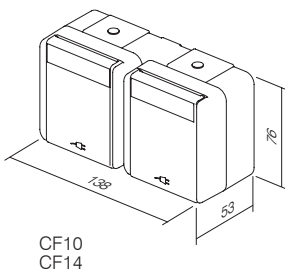
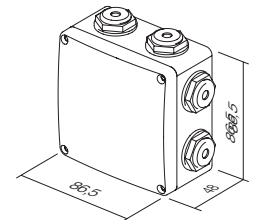

CF10
CF14

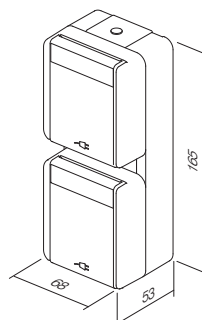

CF11
CF15

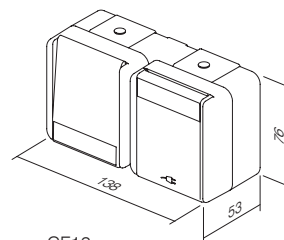

CF12
CF16

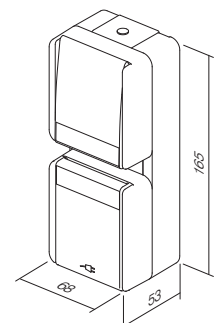

CF13
CF17

код	описание на продукта	страница
КЛЮЧОВЕ SM		
SM10	КЛЮЧ 1WAY 16AX 250V~ 1M	44
SM11	БУТОН 1WAY 16A 250V~ 1M	44
SM12	КЛЮЧ 1WAY 20A 250V~ 1M	44
SM20	КЛЮЧ 2POLE 16AX 250V~ 1M	44
SM40	КЛЮЧ ЗА ЩОРИ 1-0-2 16AX 250V~ 1M	45
SM41	БУТОН ЗА ЩОРИ 1-0-2 16A 250V~ 1M	45
SM60	КЛЮЧ 2WAY 16AX 250V~ 1M	45
SM61	БУТОН 2WAY 16A 250V~ 1M	45
SM70	КРЪСТАТ КЛЮЧ 16AX 250V~ 1M	45
SM10-	КЛЮЧ 1WAY 16AX 250V~ 1M	46
SM10-IN	КЛЮЧ 1WAY 16AX 250V~ 1M IN	46
SM11-	БУТОН 1WAY 16A 250V~ 1M	46
SM11-IN01	БУТОН 1WAY 16A 250V~ 1M IN 01	46
SM11-IN02	БУТОН 1WAY 16A 250V~ 1M IN 02	47
SM20-NT03	КЛЮЧ 2POLE 16AX 250V~ 1M NT 03	47
SM20-IN	КЛЮЧ 2POLE 16AX 250V~ 1M IN	47
SM40-NT10	КЛЮЧ ЗА ЩОРИ 1-0-2 16AX 250V~ 1M NT 10	47
SM41-NT10	БУТОН ЗА ЩОРИ1-0-2 16A 250V~ 1M NT 10	47
SM60-	КЛЮЧ 2WAY 16AX 250V~ 1M IN	47
SM61-	БУТОН 2WAY 16A 250V~ 1M	48
SM62-CD	БУТОН 2WAY С ШНУР 16A 250V~ 1M __ CD	48
SM70-	КРЪСТАТ КЛЮЧ 16AX 250V~ 1M	48
БУТОНИ TM		
TM11-	БУТОН 1M	49
TM11-IN	БУТОН 1M IN	59
TM12-	БУТОН 2M	49
TM12-IN	БУТОН 2M IN	49
TM13-IL	БУТОН 2M С ПАНЕЛ С НАДПИС	50
TM15-	БУТОН 1M 2POLE	50
TM21-	КАПАЧЕ 1M	50
TM22-	КАПАЧЕ 2M	50
TM31-	ИЗХОД ЗА КАБЕЛ 1M	50
СИГНАЛИЗАЦИЯ IA		
IA100R	НЕОНОВА ЛАМПА 230 V~ 0,34 W	52
IA20-	СВЕТОДИОДНА СИГНАЛИЗАЦИЯ 230 V AC/DC 0,4W	52
IA21-	СВЕТОДИОДНА СИГНАЛИЗАЦИЯ 24 V AC/DC 0,2W	52
IA22-	СВЕТОДИОДНА СИГНАЛИЗАЦИЯ 12V AC/DC 0,10W	52
IA50	RC ВЕРИГА 250 V	52
КЛЮЧОВЕ SP		
SP10	ЕДНОПОЛЮСОВ КЛЮЧ 16AX 250V~ 1M	54
SP11	ЕДНОПОЛЮСОВ КЛЮЧ 16A 250V~ 1M	54
SP12	ЕДНОПОЛЮСОВ КЛЮЧ 20A 250V~ 1M	54
SP20	ДВУПОЛЮСЕН КЛЮЧ 16AX 250V~ 1M	54
SP40	ДВУПОЛЮСЕН КЛЮЧ 16AX 250V~ 1M	55
SP41	БУТОН ЗА ЩОРИ 1-0-2 16A 250V~ 1M	55
SP60	РОТАЦИОНЕН КЛЮЧ 16AX 250V~ 1M	55
SP61	РОТАЦИОНЕН КЛЮЧ 16A 250V~ 1M	55
SP70	КРЪСТАТ КЛЮЧ 16AX 250V~ 1M	55
КОНТАКТИ VM		
VM10-	КОНТАКТ ШУКО+KS 2P+E 16A 250V~ 2M	56
VM11-	КОНТАКТ ШУКО+KS+КАПАК 2P+E 16A 250V~ 2M	56
VM20-	КОНТАКТ EURO+KS 2P 10A 250V~ 1M	57
VM40-	КОНТАКТ ФРЕНСКИ+KS 2P+E 16A 250V~ 2M	57
VM41-	КОНТАКТ ФРЕНСКИ+KS+КАПАК 2P+E 16A 250V~ 2M	57
VM30-	КОНТАКТ ИТАЛИАНСКИ R17/11+KS 2P+E 16A 250V~ 1M	57
VM31-	КОНТАКТ ШУКО/ИТАЛИАНСКИ R17/11+KS 2P+E 16A 250V~ 2M	57
VM32-	КОНТАКТ ШУКО/ИТАЛИАНСКИ R30+KS 2P+E 16A 250V~ 2M	58
VM33-	КОНТАКТ ИТАЛИАНСКИ R11+KS 2P+E 10A 250V~ 1M	58
VM21-	КОНТАКТ EURO/АМЕРИКАНСКИ+KS 2P 16A 250V~ 1M	58
VM52-	КОНТАКТ БРИТАНСКИ BS 1363+KS 2P+E 13A 250V~ 2M	58
VM55-	КОНТАКТ МУЛТИСТАНДАРТНИЯТ+KS 2P+E 13A 250V~ 2M	58
VM80	УСТРОЙСТВО ЗА ЗАЩИТА СРЕЩУ ОТСКОЦИ НА НАПРЕЖЕНИЕТО MPE MINI 275V/50Hz	58

код	описание на продукта	страница
КОМУНИКАЦИИ KM		
KM10-	КОНЕКТОР ЗА ТВ ОСНОВЕН 0 dB 1M	60
KM20-	КОНЕКТОР ЗА ТВ ОСНОВЕН 0 dB 2M	60
KM11-	КОНЕКТОР ЗА ТВ КРАЕН 1 dB 1M	60
KM12-	КОНЕКТОР ЗА ТВ ПРЕХОДЕН 10 dB 1M	60
KM15-	КОНЕКТОР ЗА САТЕЛИТНА ТВ ОСНОВЕН 0 dB 1M	61
KM24-	КОНЕКТОР ЗА САТЕЛИТНА ТВ ОСНОВЕН 0 dB 2M	61
KM16-	КОНЕКТОР ЗА САТЕЛИТНА ТВ КРАЕН 1 dB 1M	61
KM19-	КОНЕКТОР ЗА РАДИО ОСНОВЕН 0 dB 1M	62
KM29-	КОНЕКТОР ЗА РАДИО ОСНОВЕН 0 dB 2M	62
KM17-	КОНЕКТОР ЗА САТЕЛИТНА ТВ КРАЕН 1 dB 1M	62
KM22-	КОНЕКТОР ЗА АУДИОСИГНАЛИ 2xRCA 1M	63
KM23-	КОНЕКТОР ЗА ВИСОКОГОВОРТЕЛИ 1M	63
KM26-	КОНЕКТОР ЗА ВИСОКОГОВОРТЕЛИ 2M	63
KM30-	КОНЕКТОР ЗА ТЕЛЕФОН LT RJ11 6/4 1M	64
KM31-	КОНЕКТОР ЗА ТЕЛЕФОН BT SEC 6/6 1M	64
KM36-	КОНЕКТОР ЗА ТЕЛЕФОН KS RJ11 6/4 1M	64
KM37-	КОНЕКТОР CAT5e KS RJ45 8/8 1M	64
KM35-	АДАПТЕР KS 1M	64
KM38-	АДАПТЕР KS СЪС ЗАЩИТА ПРОТИВ ПРАХ 1M	64
KM39-	КОНЕКТОР CAT6 SCH KS RJ45 8/8 1M	65
KM50-	УНИВЕРСАЛЕН АДАПТЕР KS UNIVERSAL 1M	65
KM40-	АДАПТЕР PD 1M	65
KM43-	АДАПТЕР PD СЪС ЗАЩИТА ПРОТИВ ПРАХ 1M	65
KM46-	АДАПТЕР R&M 1M	66
KM52-	АДАПТЕР R&M CAT6A 1M	66
KM47-	АДАПТЕР R&M СЪС ЗАЩИТА ПРОТИВ ПРАХ 1M	66
KM53-	АДАПТЕР R&M CAT6A СЪС ЗАЩИТА ПРОТИВ ПРАХ 1M	66
KM45-	АДАПТЕР LK 1M	67
KA26	АДАПТЕР NEXANS/SCHRACK 2M	67
KM48-	АДАПТЕР AT&T SYSTIMAX СЪС ЗАЩИТА ПРОТИВ ПРАХ 1M	67
KM51-	КОНЕКТОР USB ТИП А 1M	67
КОМУНИКАЦИОННИ ПРИНАДЛЕЖНОСТИ КА		
KA10	КОНЕКТОР KS RJ11 RJ11 6/4	68
KA11	КОНЕКТОР KS CAT5e RJ45 8/8	68
KA12	КОНЕКТОР KS CAT5eS RJ45 8/8	68
KA15	КОНЕКТОР KS RJ45 SCHRACK RJ45 8/8	69
KA16	КОНЕКТОР KS RJ45 SCHRACK RJ45 8/8	69
KA17	КОНЕКТОР KS CAT6a SCHRACK RJ45 8/8	69
KA18	КОНЕКТОР KS RJ45 SCHRACK RJ45 8/8	69
KA27	КОНЕКТОР KS HDMI	69
KA28	КАБЕЛ KS HDMI	69

код	описание на продукта	страница	код	описание на продукта	страница
ЕЛЕКТРОНИКА ЕМ			ПРОДУКТОВА ГАМА ПАНЕЛИ OL		
EM12-	ДИМЕР, ВЪРТЯЩ ТИП/2WAY RL 300W 1M	70	OL10-	ПАНЕЛ LINE 1/2M	106
EM13-	ДИМЕР, ВЪРТЯЩ ТИП/2WAY LED 60W 1M	71	OL20-	ПАНЕЛ LINE 2M	106
EM14-	ДИМЕР, ВЪРТЯЩ ТИП/2WAY LED 180W 1M	71	OL24-	ПАНЕЛ LINE 2x2M	106
EM15-	ДИМЕР, ВЪРТЯЩ ТИП, R 250W 1M	72	OL26-	ПАНЕЛ LINE 3x2M	106
EM23	ДИМЕР, ВГРАДЕН R (250 W), (RC, RL 200VA)	72	OL28-	ПАНЕЛ LINE 4x2M	106
EM16-	1 - 10 V ДИМЕР, ВЪРТЯЩ ТИП, ДВУПОСОЧЕН	73	OL29-	ПАНЕЛ LINE 5x2M	106
EM17	УПРАВЛЯВАЩ МОДУЛ MZC за EM18	74	OL13-	ПАНЕЛ LINE 1/3M	107
EM18	ДИМЕРНО УСТРОЙСТВО ЗА СВЕТОДИОДИ 250W	74	OL30-	ПАНЕЛ LINE 3M	107
EM19	ДИМЕРНО УСТРОЙСТВО ЗА СВЕТОДИОДИ, ПОСТОЯНЕН ТОК 96 W8175	75	OL40-	ПАНЕЛ LINE 4M	107
EM25-	КЛЮЧ/УНИВЕРСАЛЕН ДИМЕР RLC 0-300W 2M	76	OL70-	ПАНЕЛ LINE 7M	107
EM26-	БУТОННО УСТРОЙСТВО ЗА УПРАВЛЕНИЕ 2M	78	OL71-	ПАНЕЛ LINE 2x7M	107
EM25PPOL20	КОМПЛЕКТ КЛЮЧ/УНИВЕРСАЛЕН ДИМЕР RLC 0-300W 2M PP OL20	78	OL23-	ПАНЕЛ LINE 2/3M	107
EM27	ЧЕСТОТЕН ФИЛТЪР	79	ПАНЕЛИ SOFT OS		
EM28-	КОНЗОЛА НА СТОПЯЕМИЯ ПРЕДПАЗИТЕЛ 230 VAC, 50Хц 1M	79	OS10-	ПАНЕЛ SOFT 1/2M	110
EM29	ПРЕДПАЗИТЕЛ	79	OS20-	ПАНЕЛ SOFT 2M	110
EM31-	КЛЮЧ IR SWITCH 5A 230V~ 1M	79	OS24-	ПАНЕЛ SOFT 2x2M	110
EM32-	КЛЮЧ IR SWITCH 5A 230V~ 2M	80	OS26-	ПАНЕЛ SOFT 3x2M	110
EM33-	СЕНЗОРЕН КЛЮЧ 5 A 230 V~ 1M	80	OS28-	ПАНЕЛ SOFT 4x2M	110
EM38-	ТЕРМОСТАТ ЗА ОТОПЛЕНИЕ 5(2) A 230 V~ 2M	82	OS13-	ПАНЕЛ SOFT 1/3M	111
EM39	ТЕРМОСТАТ ЗА ОТОПЛЕНИЕ/ОХЛАЖДАНЕ 3(1,5) A 230 V~ 2M	83	OS30-	ПАНЕЛ SOFT 3M	111
NM39	МОНТАЖНА РАМКА С ВИНТОВЕ ЗА ТЕРМОСТАТИ FANTINI COSMI 3M	84	OS40-	ПАНЕЛ SOFT 4M	111
EM46-	КЛЮЧ С КАРТА 16 A / 230 VAC, 50 Hz 3M	84	OS70-	ПАНЕЛ SOFT 7M	111
EM44-	КЛЮЧ С КАРТА ЗА ИКОНОМИЯ НА ЕНЕРГИЯ RF HF 13,56 Mhz 3M	85	OS71-	ПАНЕЛ SOFT 2x7M	111
EM47	ISO КАРТА	85	OS72-	ПАНЕЛ SOFT 2x7M	111
EM49	УСТРОЙСТВО ЗА УПРАВЛЕНИЕ ЗА ИКОНОМИЯ НА ЕНЕРГИЯ 2x16A 250V~	86	OS23-	ПАНЕЛ SOFT 2/3M	111
EM45	РАЗПРЕДЕЛИТЕЛ SPL-1	86	ПАНЕЛИ PURE OP		
EM60-	КОНТАКТ ЗА САМОБЪРСНАЧКА 230V~/120V~ 3M	87	OP13-	ПАНЕЛ PURE 1/3M	116
EM57	АВАРИЙНА СВЕТОДИОДНА ЛАМПА 230V~ 50 Hz, 0,5 W, NiMH 2h 2M	87	OP20-	ПАНЕЛ PURE 2M	116
EM55	СВЕТОДИОДНО АВАРИЙНО ОСВЕТЛЕНИЕ 250 V~ 0,90 W, NiCd 3h 7M	88	OP24-	ПАНЕЛ PURE 2x2M	116
EM69-	ЗАРЯДНО УСТРОЙСТВО USB PD 20W	89	OP26-	ПАНЕЛ PURE 3x2M	116
EM50-	LED АМБИЕНТАЛНА ЧАСТ ЕДНОЦВЕТНА 250V~ 0,8W 2M	90	OP28-	ПАНЕЛ PURE 4x2M	117
EM51-	ДВУЦВЕТНА СВЕТОДИОДНА ЛАМПА 250V~ 2x0,4W 2M	90	OP30-	ПАНЕЛ PURE 3M	117
EM52-	ДВУЦВЕТНА СВЕТОДИОДНА ЛАМПА 3D 250V~ 2x0,4W 2M	90	OP40-	ПАНЕЛ PURE 4M	117
EM71-	ПРЕВКЛЮЧАТЕЛ С ПРЪСТОВ ОТПЕЧАТЪК BIOPASS 2M	91	OP70-	ПАНЕЛ PURE 7M	117
EM82-	МУЛТИФУНКЦИОНАЛЕН ВРЕМЕВИ КЛЮЧ	92	OP23-	ПАНЕЛ PURE 2/3M	117
EM90-	ЗУМЕР 8 VA 230 V~ 1M	94	ПАНЕЛИ EDGE OG		
EM91-	ЗУМЕР 8VA 12V~ 1M	94	OG10-P	ПАНЕЛ EDGE 1/2M	120
EM92-	ЗВЪНЕЦ 8 VA 230 V~ 1M	94	OG20-P	ПАНЕЛ EDGE 2M	120
EM93-	ЗУМЕР 8VA 12V~ 1M	95	OG13-P	ПАНЕЛ EDGE 1/3M	121
EM94-	ЕЛЕКТРОНЕН ЗВЪНЕЦ 230V~ 6mA rms 1M	95	OG30-P	ПАНЕЛ EDGE 3M	121
EM95-	РЕГУЛАТОР НА СИЛАТА НА ЗВУКА 100V AUDIO LINE 35W 2M	96	OG40-P	ПАНЕЛ EDGE 4M	121
EM96-	РЕГУЛАТОР НА СИЛАТА НА ЗВУКА 4 - 8 Ω 35 W 2M	96	OG70-P	ПАНЕЛ EDGE 7M	121
КОМПЛЕКТИ СМ			OG23-P	ПАНЕЛ EDGE 2/3M	121
SM10-	КОМПЛЕКТ КОНТАКТИ 2 x ШУКО 2P+E 16A 250V~ 4M	97	ПАНЕЛИ EDGE OG		
SM11-	КОМПЛЕКТ КОНТАКТИ 3 x ШУКО 2P+E 16A 250V~ 7M	97	OG10-M	ПАНЕЛ EDGE 1/2M	123
SM15	КОМПЛЕКТ СЪЕДИНИТЕЛНИ ПРОВОДНИЦИ 3x1,5 mm2 1M	98	OG20-M	ПАНЕЛ EDGE 2M	123
SM16	КОМПЛЕКТ СЪЕДИНИТЕЛНИ ПРОВОДНИЦИ 3x2,5 mm2 2M	98	OG24-M	ПАНЕЛ EDGE 2x2M	123
SM17	КОМПЛЕКТ ВИНТОВЕ 3.5x20	98	OG26-M	ПАНЕЛ EDGE 3x2M	123
SM18	КОМПЛЕКТ ВИНТОВЕ 3.5x35	98	OG28-M	ПАНЕЛ EDGE 4x2M	123
SM19	КОМПЛЕКТ ВИНТОВЕ 3.5x50	98	OG13-M	ПАНЕЛ EDGE 1/3M	124
SM22-	КОМПЛЕКТ КЛЮЧОВЕ С НАДПИС IP44 2M	98	OG30-M	ПАНЕЛ EDGE 3M	124
SM23-	КОМПЛЕКТ КОНТАКТИ С НАДПИС IP44 2M	98	OG40-M	ПАНЕЛ EDGE 4M	124
SM25-OL	КОМПЛЕКТ КЛЮЧ ЗА БАНЯ 3 x 20A 250 V~ 4M OL	98	OG70-M	ПАНЕЛ EDGE 7M	124
SM25-OS	КОМПЛЕКТ КЛЮЧ ЗА БАНЯ 3 x 20A 250 V~ 4M OS	98	OG23-M	ПАНЕЛ EDGE 2/3M	124
SM28-	КОМПЛЕКТ КЛЮЧОВЕ IP44 2M	99	МОНТАЖНИ РАМКИ NM		
SM29-	КОМПЛЕКТ КОНТАКТИ IP44 2M	99	NM10	МОНТАЖНА РАМКА С КРАЧЕТА 1/2M	130
NM41	МОНТАЖНА РАМКА ЗА КОМПЛЕКТ ЗА БАНЯ 4M	99	NM11	МОНТАЖНА РАМКА БЕЗ ВИНТОВЕ 1/2M	130
OL41-	ПАНЕЛ LINE ЗА КОМПЛЕКТ ЗА БАНЯ	99	NM20	МОНТАЖНА РАМКА С КРАЧЕТА 2M	130
OS41-	ПАНЕЛ SOFT ЗА КОМПЛЕКТ ЗА БАНЯ	99	NM21	МОНТАЖНА РАМКА БЕЗ ВИНТОВЕ 2M	130
АНТИБАКТЕРИАЛНА ПРОГРАМА AW			NM24	МЕТАЛНА МОНТАЖНА РАМКА С КРАЧЕТА 2M	131
TM11AW	БУТОН 1M	101	NM25	МЕТАЛНА МОНТАЖНА РАМКА БЕЗ ВИНТОВЕ 2M	131
TM11AWIN	БУТОН 1M IN	101	NM26	МОНТАЖНА РАМКА, УКРЕПЕНА С ЩИПКИ 2M	131
TM12AW	БУТОН 2M	101	NM27	УКРЕПЕНА МОНТАЖНА РАМКА БЕЗ ВИНТОВЕ 2M	131
TM12AWIN	БУТОН 2M IN	101	NM23	МОНТАЖНА РАМКА С КРАЧЕТА 2/3M	131
TM21AW	КАПАЧЕ 1M	101	NM30	МЕТАЛНА МОНТАЖНА РАМКА С ВИНТОВЕ 3M	132
TM22AW	КАПАЧЕ 2M	101	NM40	МЕТАЛНА МОНТАЖНА РАМКА С ВИНТОВЕ 4M	132
VM10AW	КОНТАКТ ШУКО+KS 2P+E 16A 250V~ 2M	102	NM70	МЕТАЛНА МОНТАЖНА РАМКА С ВИНТОВЕ 7M	132
VM11AW	КОНТАКТ ШУКО+KS+КАПАК 2P+E 16A 250V~ 2M	102	NM75	МОНТАЖНА РАМКА 7M, УКРЕПЕНА С ВИНТОВЕ	132
VM20AW	КОНТАКТ EURO+KS 2P 10A 250V~ 1M	102	NM72	МЕТАЛНА МОНТАЖНА РАМКА С ВИНТОВЕ 2x7M	132
KM11AW	КОНЕКТОР ЗА ТВ КРАЕН 1 dB 1M	102	NM32	МЕТАЛНА МОНТАЖНА РАМКА С ВИНТОВЕ 2/3M	133
KM35AW	АДАПТЕР KS 1M	102			
OS20AW	ПАНЕЛ SOFT 2M	103			
OS24AW	ПАНЕЛ SOFT 2x2M	103			
OS26AW	ПАНЕЛ SOFT 3x2M	103			
OS30AW	ПАНЕЛ SOFT 3M	103			
OS40AW	ПАНЕЛ SOFT 4M	103			
OS70AW	ПАНЕЛ SOFT 7M	103			

КУТИИ

код	описание на продукта	страница
КРЪГЛИ КОНЗОЛИ		
DE10	КРЪГЛА КОНЗОЛА ЗА ТУХЛЕНИ СТЕНИ SM60-01	136
DE11	КРЪГЛА КОНЗОЛА ЗА ТУХЛЕНИ СТЕНИ, ДЪЛБОКА SM60-06	136
DE30	СОМБИ-СЛИР SM60-03	136
DE31	СОМБИ-СЛИР SM60-04	136
DE12	КРЪГЛА КОНЗОЛА ЗА ТУХЛЕНИ СТЕНИ 65-46	137
DE13	КРЪГЛА КОНЗОЛА ЗА ТУХЛЕНИ СТЕНИ 65-60	137
DE14	ДОПЪЛНИТЕЛЕН ДЕТАЙЛ ЗА MD 65-46	137
DE32	СОМБИ-СЛИР MD 65-71	137
DE33	СОМБИ-СЛИР MD 65-91	137
DE20	ЗАЩИТЕН КАПАК ЗА КОНЗОЛА 60	137
DE21	ЗАЩИТЕН КАПАК ЗА КОНЗОЛА 65	137
DE22	ДЕКОРАТИВЕН КАПАК ЗА КОНЗОЛА SM60	137
HE10	КРЪГЛА КОНЗОЛА ЗА ТУХЛЕНИ СТЕНИ SM68x40	140
HE11	КРЪГЛА КОНЗОЛА ЗА ТУХЛЕНИ СТЕНИ SM68x55	140
BE10	КРЪГЛА КОНЗОЛА ЗА СТЕНИ ОТ БЕТОН 60-49	140
BE11	КРЪГЛА КОНЗОЛА ЗА СТЕНИ ОТ БЕТОН 60-77	140
BE20	ЗАДНА ОПОРА ЗА КОНЗОЛА ЗА СТЕНИ ОТ БЕТОН	140
BE21	ОГРАНИЧИТЕЛ ЗА ТРЪЧИ ЗА КОНЗОЛИ ЗА СТЕНИ ОТ БЕТОН 16	140
ПРАВОЪГЪЛНИ КОНЗОЛИ		
DM30	ПРАВОЪГЪЛНА КОНЗОЛА ЗА ТУХЛЕНИ СТЕНИ RM3	144
DM31	ПРАВОЪГЪЛНА КОНЗОЛА ЗА ТУХЛЕНИ СТЕНИ RM3-65	144
DM40	ПРАВОЪГЪЛНА КОНЗОЛА ЗА ТУХЛЕНИ СТЕНИ RM4	144
DM41	ПРАВОЪГЪЛНА КОНЗОЛА ЗА ТУХЛЕНИ СТЕНИ RM4-65	144
DM70	ПРАВОЪГЪЛНА КОНЗОЛА ЗА ТУХЛЕНИ СТЕНИ RM7	145
DM71	ПРАВОЪГЪЛНА КОНЗОЛА ЗА ТУХЛЕНИ СТЕНИ RM7-65	145
DM72	ПРАВОЪГЪЛНА КОНЗОЛА ЗА ТУХЛЕНИ СТЕНИ RM72-65	145
DM80	ДИСТАНЦИОНЕН ЕЛЕМЕНТ ЗА КОНЗОЛА RM	145
DM33	ЗАЩИТЕН КАПАК ЗА КОНЗОЛА RM3	146
DM34	ДЕКОРАТИВЕН КАПАК ЗА КОНЗОЛА RM3	146
DM43	ЗАЩИТЕН КАПАК ЗА КОНЗОЛА RM4	146
DM44	ДЕКОРАТИВЕН КАПАК ЗА КОНЗОЛА RM4	146
DM73	ЗАЩИТЕН КАПАК ЗА КОНЗОЛА RM7	146
DM74	ДЕКОРАТИВЕН КАПАК ЗА КОНЗОЛА RM7	146
DM75	ДЕКОРАТИВЕН КАПАК ЗА КОНЗОЛА RM72	147
NM30	ПРАВОЪГЪЛНА КОНЗОЛА ЗА КУХИ СТЕНИ VM3	148
NM40	ПРАВОЪГЪЛНА КОНЗОЛА ЗА КУХИ СТЕНИ VM4	148
NM70	ПРАВОЪГЪЛНА КОНЗОЛА ЗА КУХИ СТЕНИ VM7	148
NM72	ПРАВОЪГЪЛНА КОНЗОЛА ЗА КУХИ СТЕНИ VM72	148
BM30	ПРАВОЪГЪЛНА КОНЗОЛА ЗА СТЕНИ ОТ БЕТОН BM3	149
BM40	ПРАВОЪГЪЛНА КОНЗОЛА ЗА СТЕНИ ОТ БЕТОН BM4	149
BM70	ПРАВОЪГЪЛНА КОНЗОЛА ЗА СТЕНИ ОТ БЕТОН BM7	149
BM80	FIXING СОМБИ-СЛИР BM	149
BM82	ДИСТАНЦИОНЕН ЕЛЕМЕНТ ЗА КОНЗОЛИ BM	149
СЪЕДИНИТЕЛНИ КУТИИ		
DW10	КРЪГЛА СЪЕДИНИТЕЛНА КОНЗОЛА ЗА ТУХЛЕНИ СТЕНИ DSM78	152
NW10	КРЪГЛА СЪЕДИНИТЕЛНА КОНЗОЛА ЗА КУХИ СТЕНИ SM78x45	152
DE23	ДЕКОРАТИВЕН КАПАК ЗА КОНЗОЛА SM78	152
DE24	ЗАЩИТЕН КАПАК ЗА КОНЗОЛА 78	152
NW20	КВАДРАТНА СЪЕДИНИТЕЛНА КОНЗОЛА ЗА КУХИ СТЕНИ SM105x105	152
ПРИНАДЛЕЖНОСТИ ЗА СВЪРЗВАНЕ		
UW10-	1 РЕД КЛЕМОРЕДИ ЗАТВОРЕНИ РС 2x2,5 mm ² 10P	154
UW11-	1 РЕД КЛЕМОРЕДИ ЗАТВОРЕНИ РС 2x4 mm ² 10P	154
UW12-	1 РЕД КЛЕМОРЕДИ ЗАТВОРЕНИ РС 2x6 mm ² 10P	154
UW15-	1 РЕД КЛЕМОРЕДИ РА 2x2,5 mm ² 12P	154
UW16-	1 РЕД КЛЕМОРЕДИ РА 2x4 mm ² 12P	154
UW17-	1 РЕД КЛЕМОРЕДИ РА 2x6 mm ² 12P	154
UW29-	2 РЕДА КЛЕМОРЕДИ РР 1,0-4,0 mm ² 12P	154
UW30-	2 РЕДА КЛЕМОРЕДИ РР 1,5-6,0 mm ² 12P	154
UW31-	2 РЕДА КЛЕМОРЕДИ РР 2,5-10 mm ² 12P	154
UW32-	2 РЕДА КЛЕМОРЕДИ РР 4,0-16 mm ² 12P	154
UW27-	2 РЕДА КЛЕМОРЕДИ РА 2,5-10 mm ² 12P	155
UW28-	2 РЕДА КЛЕМОРЕДИ РА 4,0-16 mm ² 12P	155
UW40-	СЪЕДИНИТЕЛИ С ВКАРВАНЕ НА ПРОВОДНИЦИТЕ РА 1,5 mm ² 3P	155
UW41-	СЪЕДИНИТЕЛИ С ВКАРВАНЕ НА ПРОВОДНИЦИТЕ РА 1,5 mm ² 5P	155
UW42-	СЪЕДИНИТЕЛИ С ВКАРВАНЕ НА ПРОВОДНИЦИТЕ РА 1,5 mm ² 8P	155
UW45-	СЪЕДИНИТЕЛИ С ВКАРВАНЕ НА ПРОВОДНИЦИТЕ РА 2,5mm ² 3P	155
UW46-	СЪЕДИНИТЕЛИ С ВКАРВАНЕ НА ПРОВОДНИЦИТЕ РА 2,5mm ² 4P	155
UW47-	СЪЕДИНИТЕЛИ С ВКАРВАНЕ НА ПРОВОДНИЦИТЕ РА 2,5mm ² 5P	155
UW50-	СЪЕДИНИТЕЛИ С ВКАРВАНЕ НА ПРОВОДНИЦИТЕ РА 2,5 mm ² 2/1P	155

разпределение

код	описание на продукта	страница
КОНЗОЛИ CUVO IP20 AC		
AC11-	КОНЗОЛА NO CUVO СЪС ЗАДЕН КАПАК IP20 1M	158
AC21-	КОНЗОЛА NO CUVO СЪС ЗАДЕН КАПАК IP20 2M	158
AC41-	КОНЗОЛА NO CUVO СЪС ЗАДЕН КАПАК IP20 4M	158
AC61-	КОНЗОЛА NO CUVO СЪС ЗАДЕН КАПАК IP20 6M	158
КОНЗОЛИ CUVO IP55 AQ		
AQ20-	КОНЗОЛА NO CUVO IP55 2M	159
AQ22-	КОНЗОЛА NO CUVO IP55 2x2M	159
AQ30-	КОНЗОЛА NO CUVO IP55 3M	159
AQ21-	КУТИЯ PO CUVO IP55 2M	160
AQ31-	КОНЗОЛА PO CUVO IP55 3M	160
СИСТЕМА ЗА КАНАЛ ЗА КАБЕЛИ МА		
RT10	АДАПТЕР МА 162	161
RT12-	ПАНЕЛ МА 92 2/3M	161
RT14-	ПАНЕЛ МА 162 4M	161
RT17-	ПАНЕЛ МА 162 7M	161
RT20-	ОСНОВА ЗА КАНАЛ МА 130x65	162
RT21-	ОСНОВА ЗА КАНАЛ МА 165x65	162
RT25	ПРЕДЕН КАПАК МА 92	162
RT30	КАБЕЛНА СКАРА МА 43	162
RT31	КАБЕЛНА СКАРА МА 43 AL	162
RT32	КАБЕЛНА СКАРА МА 43 AL ДВОЙНА	162
RT35-	КРАЕН ЕЛЕМЕНТ МА 130x65	163
RT36-	КРАЕН ЕЛЕМЕНТ МА 165x65	163
RT38	КОМПЛЕКТ СЪЕДИНИТЕЛЕН ЕЛЕМЕНТ МА 65	163
RT40-	УНИВЕРСАЛЕН ЪГЛОВ ЕЛЕМЕНТ МА 130x65	163
RT41-	УНИВЕРСАЛЕН ЪГЛОВ ЕЛЕМЕНТ МА 165x65	163
RT42	ЗАЗЕМИТЕЛЕН ЕЛЕМЕНТ МА 2x A6.3	163
RT43-	ЛКОЛЯНО МА 130x65 / 130	163
RT44-	ЛКОЛЯНО МА 165x65 / 130	164
RT47-	ЛКОЛЯНО МА 165x65 / 165	164
RT45-	Т-КОЛЯНО МА 130x65 / 130	164
RT46-	Т-КОЛЯНО МА 165x65 / 130	164
RT48-	Т-КОЛЯНО МА 165x65 / 165	164
RT50-	ЕДИНИЧНА ЗАКРЕПВАЩА ПЛАСТИНА МА 130x65	165
RT51-	ДВОЙНА ЗАКРЕПВАЩА ПЛАСТИНА МА 130x65	165
RT52-	СЕРВИЗНА КОЛОНА МА 130x65x500	165
RT53-	ДВОЙНА СЕРВИЗНА КОЛОНА МА 130x65x500	165
ПОДОВИ КОНЗОЛИ MT		
RB50	ОСНОВА ЗА ПОДОВА КОНЗОЛА 4M	167
RB60	ВЛОЖКА ЗА ПОДОВА РАЗПРЕДЕЛИТЕЛНА КОНЗОЛА 4M	167
RB65S1	КАПАК ЗА ПОДОВА РАЗПРЕДЕЛИТЕЛНА КОНЗОЛА 4M	167
RB51	ОСНОВА ЗА ПОДОВА КОНЗОЛА 7M	167
RB61	ВЛОЖКА ЗА ПОДОВА РАЗПРЕДЕЛИТЕЛНА КОНЗОЛА 7M	167
RB66S1	КАПАК ЗА ПОДОВА РАЗПРЕДЕЛИТЕЛНА КОНЗОЛА 7M	167
RB52	ОСНОВА ЗА ПОДОВА КОНЗОЛА 2X7M	168
RB62	ВЛОЖКА ЗА ПОДОВА РАЗПРЕДЕЛИТЕЛНА КОНЗОЛА 2X7M	168
RB67S2	КАПАК ЗА ПОДОВА РАЗПРЕДЕЛИТЕЛНА КОНЗОЛА 2X7M	168
RB53	ОСНОВА ЗА ПОДОВА КОНЗОЛА 4X7M	168
RB62	ВЛОЖКА ЗА ПОДОВА РАЗПРЕДЕЛИТЕЛНА КОНЗОЛА 2X7M	168
RB68S2	КАПАК ЗА ПОДОВА РАЗПРЕДЕЛИТЕЛНА КОНЗОЛА 4X7M	168
RB55S1	ПОДОВА КОНЗОЛА С КАПАК ЗА ДВОЕН ПОД 4M	169
RB60	ВЛОЖКА ЗА ПОДОВА РАЗПРЕДЕЛИТЕЛНА КОНЗОЛА 4M	169
RB56S1	ПОДОВА КОНЗОЛА С КАПАК ЗА ДВОЕН ПОД 7M	170
RB61	ВЛОЖКА ЗА ПОДОВА РАЗПРЕДЕЛИТЕЛНА КОНЗОЛА 7M	170
RB57S2	ПОДОВА КОНЗОЛА С КАПАК ЗА ДВОЕН ПОД 2X7M	170
RB62	ВЛОЖКА ЗА ПОДОВА РАЗПРЕДЕЛИТЕЛНА КОНЗОЛА 2X7M	170
RB58S2	ПОДОВА КОНЗОЛА С КАПАК ЗА ДВОЕН ПОД 4X7M	170
RB62	ВЛОЖКА ЗА ПОДОВА РАЗПРЕДЕЛИТЕЛНА КОНЗОЛА 2X7M	170
RB10	АДАПТЕР ЗА DIN РЕЛСА 35mm 1M	171
RB11	АДАПТЕР ЗА DIN РЕЛСА 35mm 2M	171

код	описание на продукта	страница
КЛЮЧОВЕ SQ		
SQ10-XO	КЛЮЧ 1WAY 10AX 250V~	192
SQ10-INXO	КЛЮЧ 1WAY 10AX 250V~ __ IN	192
SQ11-XO	БУТОН 1WAY 10A 250V~	192
SQ11-IN01XO	БУТОН 1WAY 10A 250V~ __ IN 01	192
SQ11-IN02XO	БУТОН 1WAY 10A 250V~ __ IN 02	193
SQ11-ILXO	БУТОН 1WAY 10A 250V~ __ IL	193
SQ22-IN03XO	КЛЮЧ 2POLE 16AX 250V~ __ IN 03	193
SQ50-XO	КЛЮЧ 2GANG-1WAY 10AX 250V~	193
SQ51-XO	БУТОН 2GANG-1WAY 10A 250V~	193
SQ52-NT09XO	КЛЮЧ ЗА ЩОРИ 10AX 250V~ __ NT 09	193
SQ53-NT09XO	БУТОН ЗА ЩОРИ 10A 250V~ __ NT 09	194
SQ60-XO	КЛЮЧ 2WAY 10AX 250V~	194
SQ60-INXO	КЛЮЧ 2WAY 10AX 250V~ __ IN	194
SQ60-IN02XO	КЛЮЧ 2WAY 10AX 250V~ __ IN 02	194
SQ63-XO	ДВОЕН КЛЮЧ 2WAY 10AX 250V~	195
SQ70-XO	КРЪСТАТ КЛЮЧ 10AX 250V~	195
СИГНАЛИЗАЦИЯ IA		
IA10-	НЕОНОВА ЛАМПА 230 V~ 0,34 W	196
IA20-	СВЕТОДИОДНА СИГНАЛИЗАЦИЯ 230V ~ AC/DC 0,4W	196
IA21-	СВЕТОДИОДНА СИГНАЛИЗАЦИЯ 24 V AC/DC 0,2W	196
IA22-	СВЕТОДИОДНА СИГНАЛИЗАЦИЯ 12 V AC/DC 0,1W	196
КОНТАКТИ VQ		
VQ10-XO	КОНТАКТ ШУКО 2P+E 16A 250V~ __ XO	199
VQ11-XO	КОНТАКТ ШУКО+КАПАК 2P+E 16A 250V~ __ XO	199
VQ12-XO	КОНТАКТ ШУКО 2P+E 16A 250V~ BV __ XO	199
VQ13-XO	КОНТАКТ ШУКО+КАПАК 2P+E 16A 250V~ BV __ XO	199
VQ40-XO	КОНТАКТ ФРЕНСКИ 2P+E 16A 250V~ __ XO	200
VQ16-	КОНТАКТ ШУКО ДВОЕН 2P+E 16A 250V~	200
VQ16-F	КОНТАКТ ШУКО ДВОЕН 2P+E 16A 250V~	200
VQ42-XO	КОНТАКТ ФРЕНСКИ 2P+E 16A 250V~ BV __ XO	201
VQ43-XO	КОНТАКТ ФРЕНСКИ+КАПАК 2P+E 16 A 250 V~ BV __ XO	201
VQ46-XO	КОНТАКТ ФРЕНСКИ ДВОЕН 2P+E 16A 250V~	201
VQ46-F	КОНТАКТ ФРЕНСКИ ДВОЕН 2P+E 16A 250V~	201
КОМУНИКАЦИИ KQ		
KQ10-XO	КОНТАКТ ЗА ТВ БА30В 0 dB	202
KQ11-XO	КОНТАКТ ЗА ТВ-РАДИО КРАЕН 1 dB	202
KQ12-XO	КОНТАКТ ЗА ТВ-РАДИО ПРЕХОДЕН 10 dB	203
KQ16-XO	КОНТАКТ ЗА САТЕЛИТНА ТВ-РАДИО КРАЕН 3 dB	203
KQ22-XO	КОНТАКТ ЗА АУДИОСИГНАЛИ 2xRCA	203
KQ23-XO	КОНТАКТ ЗА ВИСОКОГОВОРТЕЛИ	204
KQ36-XO	КОНЕКТОР ЗА ТЕЛЕФОН KS RJ11 6/4	204
KQ37-XO	КОНЕКТОР CAT5e KS RJ45 8/8	204
KQ38-XO	КОНЕКТОР ЗА ТЕЛЕФОН KS ДВОЕН 2x RJ11 6/4	204
KQ39-XO	КОНЕКТОР CAT5e KS ДВОЕН 2x RJ45 8/8	205
KQ35-XO	КОНЕКТОР ЗА ТЕЛЕФОН LT RJ11 6/4	205
KQ40-XO	КОНЕКТОР CAT6s KS ДВОЕН 2x RJ45 8/8 SLIM	205
KQ41-XO	КОНЕКТОР CAT6s KS ДВОЕН 2x RJ45 8/8 SLIM	205
ЕЛЕКТРОНИКА EQ		
EQ15-XO	ДИМЕР, ВЪРТЯЩ ТИП, ДВУПОСОЧЕН, АКТИВЕН/ИНДУКТИВЕН ТОВАР 400W	206
EQ16-XO	ДИМЕР, ВЪРТЯЩ ТИП, ДВУПОСОЧЕН, АКТИВЕН/ИНДУКТИВЕН/КАПАЦИТИВЕН ТОВАР 400W	206
EQ19-XO	ДИМЕР, ВЪРТЯЩ ТИП, ДВУПОСОЧЕН, ЗА СВЕТОДИОДНО ОСВЕТЛЕНИЕ 100W	206
EM17	УПРАВЛЯВАЩ МОДУЛ MZC ЗА EM18	208
EM18	ДИМЕРНО УСТРОЙСТВО ЗА СВЕТОДИОДИ 250W	208
EM19	ДИМЕРНО УСТРОЙСТВО ЗА СВЕТОДИОДИ, ПОСТОЯНЕН ТОК 96 W	209
EQ32-XO	КЛЮЧ IR 5A 230V~	210
EQ35-XO	ОТОПЛЕНИЕ С ТЕРМОСТАТ 10A 230V~	210
EQ36-XO	ОТОПЛЕНИЕ/ОХЛАЖДАНЕ С ТЕРМОСТАТ 5A 230V~	210
EQ37-XO	ПОДОВО ОТОПЛЕНИЕ С ТЕРМОСТАТ 16A 230V~	211
EQ01-XO	ПОДМАЗИЛКОВО РАДИО + ТОНКОЛОНА DAB BLUETOOTH	211
EQ02-XO	ПОДМАЗИЛКОВА ТОНКОЛОНА	211
EQ69-XO	ЗАРЯДНО УСТРОЙСТВО USB PD 20W	212

код	описание на продукта	страница
КАПАЦИ PQ		
PQ10-XO	КАПАЧЕ	213
PQ30-	ПАНЕЛ TAE/TDO	213
PQ20PWF	КОНЗОЛА ЗА ВЪНШЕН МОНТАЖ 1	214
PQ21PWF	КУТИЯ ЗА МОНТАЖ НА ПОВЪРХНОСТИ ЗА ДВОЕН КОНТАКТ	214
PQ22-F	КОМПЛЕКТ ЗА КЛЮЧОВЕ FLAT IP44	215
PQ23-F	КОМПЛЕКТ ЗА КОНТАКТИ FLAT IP44	215
РАМКИ OF		
OF10-	ПАНЕЛ FLAT 1	216
OF20-	ПАНЕЛ FLAT 2	216
OF30-	ПАНЕЛ FLAT 3	217
OF40-	ПАНЕЛ FLAT 4	217
OF50-	ПАНЕЛ FLAT 5	217
РАМКИ OQ		
OQ10-	ПАНЕЛ BOLD 1	218
OQ20-	ПАНЕЛ BOLD 2	218
OQ30-	ПАНЕЛ BOLD 3	219
OQ40-	ПАНЕЛ BOLD 4	219
OQ50-	ПАНЕЛ BOLD 5	219
РАМКИ OR		
OR10-	ПАНЕЛ PRIME 1	220
OR20-	ПАНЕЛ PRIME 2	220
OR30-	ПАНЕЛ PRIME 3	221
OR40-	ПАНЕЛ PRIME 4	221

код	описание на продукта	страница
КЛЮЧОВЕ SE		
SE10	КЛЮЧ 1WAY 10AX 250V~	232
SE11	БУТОН 1WAY 10A 250V~	232
SE22	КЛЮЧ 2POLE 16AX 250V~	232
SE50	КЛЮЧ 2GANG-1WAY 10AX 250V~	232
SE51	БУТОН 2GANG-1WAY 10A 250V~	233
SE52	КЛЮЧ ЗА ЩОРИ 10AX 250V~	233
SE53	БУТОН ЗА ЩОРИ 10A 250V~	233
SE60	КЛЮЧ 2WAY 10AX 250V~	233
SE63	ДВОЕН КЛЮЧ 2WAY 10AX 250V~	233
SE70	КРЪСТАТ КЛЮЧ 10AX 250V~	233
SE10-	КЛЮЧ 1WAY 10AX 250V~	234
SE10-IN	КЛЮЧ 1WAY 10AX 250V~ IN	234
SE11-	БУТОН 1WAY 10A 250V~	234
SE11-TI50	БУТОН 1WAY 10A 250V~ TI 50	234
SE11-TI51	БУТОН 1WAY 10A 250V~ TI 51	234
SE11-IL	БУТОН 1WAY 10A 250V~ IL	234
SE22-IN03	КЛЮЧ 2POLE 16AX 250V~ IN 03	234
SE50-	КЛЮЧ 2GANG-1WAY 10AX 250V~	235
SE51-	БУТОН 2GANG-1WAY 10A 250V~	235
SE52-NT09	КЛЮЧ ЗА ЩОРИ 10AX 250V~ NT 09	235
SE53-NT09	БУТОН ЗА ЩОРИ 10A 250V~ NT 09	235
SE60-	КЛЮЧ 2WAY 10AX 250V~	235
SE63-	ДВОЕН КЛЮЧ 2WAY 10AX 250V~	235
SE70-	КРЪСТАТ КЛЮЧ 10AX 250V~	235
БУТОНИ TE		
TE10-	БУТОН 1GANG	236
TE10-IN	БУТОН С ИНДИКАТОР	236
TE13-IL	БУТОН С ПАНЕЛ С НАДПИС IL	236
TE11-	БУТОН 2GANG	236
СИГНАЛИЗАЦИЯ IA		
IA10-	НЕОНОВА ЛАМПА 230 V~ 0,34 W	237
IA20-	СВЕТОДИОДНА СИГНАЛИЗАЦИЯ 230V ~ AC/DC 0,4W	237
IA21-	СВЕТОДИОДНА СИГНАЛИЗАЦИЯ 24 V AC/DC 0,2W	237
IA22-	СВЕТОДИОДНА СИГНАЛИЗАЦИЯ 12 V AC/DC 0,1W	237
КОНТАКТИ VE		
VE10-XO	КОНТАКТ ШУКО 2P+E 16A 250V~ XO	240
VE11-XO	КОНТАКТ ШУКО+КАПАК 2P+E 16A 250V~ XO	240
VE12-XO	КОНТАКТ ШУКО 2P+E 16A 250V~ BV XO	240
VE13-XO	КОНТАКТ ШУКО+КАПАК 2P+E 16A 250V~ BV XO	240
VE10-	КОНТАКТ ШУКО 2P+E 16A 250V~	240
VE11-	КОНТАКТ ШУКО+КАПАК 2P+E 16A 250V~	240
VE12-	КОНТАКТ ШУКО 2P+E 16A 250V~ BV	240
VE13-	КОНТАКТ ШУКО+КАПАК 2P+E 16A 250V~ BV	240
VE40-XO	КОНТАКТ ФРЕНСКИ 2P+E 16A 250V~ XO	241
VE41-XO	КОНТАКТ ФРЕНСКИ+КАПАК 2P+E 16A 250V~ XO	241
VE42-XO	КОНТАКТ ФРЕНСКИ 2P+E 16A 250V~ BV XO	241
VE43-XO	КОНТАКТ ФРЕНСКИ+КАПАК 2P+E 16A 250V~ BV XO	241
VE40-	КОНТАКТ ФРЕНСКИ 2P+E 16A 250V~	241
VE41-	КОНТАКТ ФРЕНСКИ+КАПАК 2P+E 16A 250V~	241
VE42-	КОНТАКТ ФРЕНСКИ 2P+E 16A 250V~ BV	241
VE43-	КОНТАКТ ФРЕНСКИ+КАПАК 2P+E 16A 250V~ BV	241
VE16-	ДВОЕН КОНТАКТ ШУКО 2P+E 16A 250V~	242
VE46-	ДВОЕН КОНТАКТ ФРЕНСКИ 2P+E 16A 250V~	242
VE30-	КОНТАКТ 2P 16A 250V~	242
КОМУНИКАЦИИ KE		
KE11	КОНЕКТОР ЗА ТВ-РАДИО КРАЕН 1 dB	243
KE12	КОНЕКТОР ЗА ТВ-РАДИО ПРЕХОДЕН 10 dB	243
KE16	КОНЕКТОР ЗА САТЕЛИТНА ТВ-ТВ-РАДИО КРАЕН 3 dB	243
KE36	КОНЕКТОР TEL KS RJ11 6/4	243
KE37	КОНЕКТОР CAT5e KS RJ45 8/8	244
KE40	КОНЕКТОР CAT6s KS RJ45 8/8 SLIM	244
KE38	ДВОЕН КОНЕКТОР TEL KS 2x RJ11 6/4	244
KE39	ДВОЕН КОНЕКТОР CAT5e KS 2x RJ45 8/8	244
KE41	ДВОЕН КОНЕКТОР CAT6s KS 2x RJ45 8/8 SLIM	244
KE45	ЕДИНИЧЕН АДАПТЕР KS	244
KE46	ДВОЕН АДАПТЕР KS	245
KE47	ДВОЕН АДАПТЕР PD	245
KE10-	КОНЕКТОР ЗА ТВ ОСНОВЕН 0 dB	246
KE11-	КОНЕКТОР ЗА ТВ-РАДИО КРАЕН 1 dB	246
KE12-	КОНЕКТОР ЗА ТВ-РАДИО ПРЕХОДЕН 10 dB	246
KE16-	КОНЕКТОР ЗА САТЕЛИТНА ТВ-ТВ-РАДИО КРАЕН 3 dB	246
KE22-	КОНЕКТОР ЗА АУДИОСИГНАЛИ 2xRCA	246
KE23-	КОНЕКТОР ЗА ВИСОКОГОВОРИТЕЛИ	246
KE36-	КОНЕКТОР TEL KS RJ11 6/4	246
KE37-	КОНЕКТОР CAT5e KS RJ45 8/8	247
KE40-	КОНЕКТОР CAT6s KS RJ45 8/8 SLIM	247
KE38-	ДВОЕН КОНЕКТОР TEL KS 2x RJ11 6/4	257
KE39-	ДВОЕН КОНЕКТОР CAT5e KS 2x RJ45 8/8	247
KE41-	ДВОЕН КОНЕКТОР CAT6s KS 2x RJ45 8/8 SLIM	247
KE35-	КОНЕКТОР TEL LT RJ11 6/4	247

код	описание на продукта	страница
КАПАЦИ PE		
PE10-	ПАНЕЛ ЗА ТВ-РАДИО 2P/3P	248
PE20-	ЕДИНИЧЕН ПАНЕЛ KS	248
PE21-	ДВОЕН ПАНЕЛ KS	248
PE30-	ПАНЕЛ TAE/TDO	248
ЕЛЕКТРОНИКА EE		
EE15	ДИМЕР, ВЪРТЯЩ ТИП ДВУПОСОЧЕН RLC 400 W	249
EE16	ДИМЕР, ВЪРТЯЩ ТИП ДВУПОСОЧЕН RLC 400 W	249
EE19	ДИМЕР, ВЪРТЯЩ ТИП ДВУПОСОЧЕН RLC 100 W	250
EE32	IR КЛЮЧ 5 A 230V~	250
EE15-	ДИМЕР, ВЪРТЯЩ ТИП ДВУПОСОЧЕН RLC 400 W	251
EE16-	ДИМЕР, ВЪРТЯЩ ТИП ДВУПОСОЧЕН RLC 400 W	251
EE19-	ДИМЕР, ВЪРТЯЩ ТИП ДВУПОСОЧЕН RLC 100 W	251
EE32-	КЛЮЧ IR 5A 230V~	251
EE69-	ЗАРЯДНО УСТРОЙСТВО USB PD 20W	252
ПАНЕЛИ ЗА ЕЛЕКТРОНИКА PE		
PE41-	ПАНЕЛ ЗА ДИМЕР Ø6	254
PE32-	ПАНЕЛ IR КЛЮЧ	254
ПРИНАДЛЕЖНОСТИ AE		
AE10-	КАПАЧЕ	255
AE20-	СЪЕДИНИТЕЛНА КОНЗОЛА 5POLE 3P+N+E 5x4 mm ²	255
AE30-	КОНЗОЛА ЗА ВЪНШЕН МОНТАЖ 1	255
AE31-	КУТИЯ ЗА МОНТАЖ НА ПОВЪРХНОСТИ ЗА ДВОЕН КОНТАКТ	255
AE50-	СТЕННА ЗАЩИТА	256
AE51-	ЗАЩИТА ЗА ДЕЦА KS	256
РАМКИ OE		
OE10-	РАМКА ЕКОНОМИК 207	257
OE20-	РАМКА ЕКОНОМИК 2 ХОРИЗОНТАЛНА	257
OE21-	РАМКА ЕКОНОМИК 2 ВЕРТИКАЛНА	257
OE30-	РАМКА ЕКОНОМИК 3 ХОРИЗОНТАЛНА	257
OE31-	РАМКА ЕКОНОМИК 3 ВЕРТИКАЛНА	258
OE40-	РАМКА ЕКОНОМИК 4 ХОРИЗОНТАЛНА	258
OE41-	РАМКА ЕКОНОМИК 4 ВЕРТИКАЛНА	258
OE50-	РАМКА ЕКОНОМИК 5 ХОРИЗОНТАЛНА	258
OE90-	ЦВЕТНИ ДЕКОРАТИВНИ РАМКИ	259
fontana		
код	описание на продукта	страница
КЛЮЧОВЕ SF		
SF10-	КЛЮЧ 1WAY IP44 10AX 250V~	262
SF10-TI	КЛЮЧ 1WAY IP44 10AX 250V~ TI	262
SF11-TI	БУТОН 1WAY IP44 10A 250V~ TI	262
SF20-	КЛЮЧ 2POLE IP44 10AX 250V~	262
SF50-	КЛЮЧ 2GANG-1WAY IP44 10AX 250V~	263
SF51-	БУТОН 2GANG-1WAY IP44 10A 250V~	263
SF60-	КЛЮЧ 2WAY IP44 10AX 250V~	263
SF60-TI	КЛЮЧ 2WAY IP44 10AX 250V~ TI	263
SF63-	ДВОЕН КЛЮЧ 2WAY 10AX 250V~	263
SF70-	КРЪСТАТ КЛЮЧ IP44 10AX 250V~	263
КОНТАКТИ VF		
VF10-	КОНТАКТ ШУКО+КАПАК IP44 2P+E 16A 250V~	264
VF12-	КОНТАКТ ШУКО+КАПАК IP44 2P+E 16A 250V~ BV	264
КОМПЛЕКТИ CF		
CF10-	КОМПЛЕКТ КОНТАКТИ ШУКО ДВОЙНИ ХОРИЗОНТАЛНИ IP44 2x2P+E 16A 250V~	265
CF11-	КОМПЛЕКТ КОНТАКТИ ШУКО ДВОЙНИ ВЕРТИКАЛНИ IP44 2x2P+E 16A 250V~	265
CF12-	КОМПЛЕКТ КОНТАКТИ ШУКО+КЛЮЧ 2WAY ХОРИЗОНТАЛНИ IP44 16A + 10AX 250V~	265
CF13-	КОМПЛЕКТ КОНТАКТИ ШУКО+КЛЮЧ 2WAY ВЕРТИКАЛНИ IP44 16A + 10AX 250V~	266
CF14-	КОМПЛЕКТ КОНТАКТИ ШУКО ДВОЙНИ ХОРИЗОНТАЛНИ IP44 2x 2P+E 16A 250V~ BV	266
CF15-	КОМПЛЕКТ КОНТАКТИ ШУКО ДВОЙНИ ВЕРТИКАЛНИ IP44 2x 2P+E 16A 250V~ BV	266
CF16-	КОМПЛЕКТ КОНТАКТИ ШУКО+КЛЮЧ 2WAY ХОРИЗОНТАЛНИ IP44 16A + 10AX 250V~ BV	266
CF17-	КОМПЛЕКТ КОНТАКТИ ШУКО+КЛЮЧ 2WAY ВЕРТИКАЛНИ IP44 16A + 10AX 250V~ BV	266
ПРИНАДЛЕЖНОСТИ AF		
AF10-	РАЗПРЕДЕЛИТЕЛНА КУТИЯ IP44 RN01	267
AF20-	РАЗПРЕДЕЛИТЕЛНА КУТИЯ IP55 ND01	267



TEM
On | Off and everything in between

ekonomik
MODUL
LOGIQ

100% ELEKTRIČEN

www.tem.si



TEM
On | Off and everything in between



TEM

M
between



www.tem.si

TEM

TEM ČATEŽ d.o.o.
Čatež 13, 8212 VELIKA LOKA
SLOVENIJA
tem@tem.si
www.tem.si

T +386(0)7 348 99 00

